



Jayco[®] Generations of family fun.

2017

NORTH POINT

FIFTHWHEELS

OWNER'S MANUAL



PRINTED ON RECYCLED PAPER

0263154.2017

ECO advantage™

THE JAYCO ECOADVANTAGE IS OUR COMPANY'S COMMITMENT TO PROTECTING THE ENVIRONMENT. Through Jayco's company-wide sustainability program, we're creating better ways to build better RV's using fewer natural resources. Already, our initiative has created significant impact. As of 2014 our company has:

Recycled



- 7,192 tons of wood
- 2,354 tons of scrap metal
- 1,428 tons of cardboard and paper

Conserved



- 9,997,400 gallons of fresh water, enough to meet the daily needs of 133,293 Americans.
- 34,277 gallons of gas, enough for Americans to drive more than 957,600 miles.
- Enough electricity to power 1,745 homes for the year.

Saved



- 60,900 mature trees.
- Enough landfill airspace to meet the annual disposal needs of a community of 44,683 people.

We're proud of our results, and we know those numbers show that a little initiative can go a long way. The Jayco EcoAdvantage is our way of making sure endless generations can enjoy the Great Outdoors.

TABLE OF CONTENTS

SECTION 1: WARRANTY & SERVICE

About This Manual	13
Warranty packet	13
Safety Alerts	13
Reporting Safety Defects	14
Manufacturing Process	15
Options & Equipment	15
Customer Responsibility	16
Change Of Address/Ownership	16
Dealer Responsibility	16
Suggestions For Obtaining Service	16
Customer Relations	17
Jayco Travel Club	18
JayPlus™ Extended Service Contract	18
Jayco Customer First Emergency Roadside Assistance	18
Obtaining Emergency Warranty Repair	19
Obtaining Service For Separately Warranted Items	20
Obtaining Service at Jayco	20
Parts & Accessories	20
Notice To Jayco Dealers	24

SECTION 2: OCCUPANT SAFETY

Secondary Means of Escape (Exit Window)	29
<i>Exit Window Label</i>	29
Fire Safety	30
Fire Extinguisher	31
Smoke Alarm	31
Combination Carbon Monoxide/ Propane Alarm	33
<i>Smoke detector warning label</i>	33
<i>LP/Carbon monoxide detector</i>	33
<i>(alarm may vary from model shown)</i>	33
Formaldehyde	36
Extended Or Full Time Usage	36
Cold Weather Usage	37
Condensation	37

SECTION 3: PRE-TRAVEL INFORMATION

Tow Vehicle	39
Vehicle Labels	39
Weight Terms	39
<i>OCCC Label (yellow)</i>	40
<i>Federal Certification Label</i>	40
<i>Tire & Loading Information</i>	40
Weight and Capacity Labels	40
Loading Your Recreation Vehicle	41
Cargo Carrying Accessory Receiver (If So Equipped)	42
Rear Bumper	42
Fifth Wheel Pin Box (Customer Supplied)	42
Fifth Wheel Hitching Procedure	43
Wire Harness/Connector Plug	44
Weighing Your Tow Vehicle & RV	44
<i>7-Way trailer plug-car end-rear view</i>	44

SECTION 4: VEHICLE OPERATION

Towing	47
Towing Behind Your RV	48
RV Brake System	48

TABLE OF CONTENTS

Electric brakes	48
Travel Trailer Breakaway Switch	49
Hydraulic brakes (if so equipped)	49
Disc Brakes (if so equipped)	50
Entrance Door Step(s)	50
Entrance Door	50
Keys	50
Keyless Entry (if so equipped)	50
<i>RV Step</i>	50
Battery powered keyless entry system:	51
Campsite Hook-Up	54
Leveling the RV	54
Lippert Auto Leveling System (If So Equipped)	54
Basic Jack Operation	56
Stabilizer Jacks	57
Manual stabilizer jacks (if so equipped)	57
Electric stabilizer jacks (if so equipped)	57
Emergency Stopping	57
Emergency Towing	58
Wheel Lugs	58
Tires	59
Changing A Tire	61
Spare Tire Carrier (If So Equipped)	62
Hoist mount	62
<i>Hoist mount with brackets</i>	63
<i>travel position</i>	63
<i>Hoist mount/flush mount</i>	63
<i>travel position</i>	63
<i>Crank access port</i>	63
Bumper mount	64
To extend the tire down	64
To remove the tire from the tire carrier	64
To install the tire on the tire carrier	64
Fifth Wheel Set Up	64
Patio Awning	64
<i>Bumper mount</i>	64
Awning care	65
Power Awnings (If So Equipped)	65
Carefree® Awnings (If So Equipped)	65
Keep the awning fabric and arms clean.Carefree® LONGITUDE	
Awnings (If So Equipped) - Emergency Operation	67

SECTION 5: SLIDEOUT SYSTEMS

Electric Slide Room(s) (If So Equipped)	71
Slideout Systems	72
Schwintek Inwall slideout system	72
<i>Slideout overlap-outside</i>	72
Troubleshooting the Slideout	72
Retracting slideout room	73
Trouble shooting the Inwall slideout system	74
Manual override for the inwall slideout	74
Flush Floor Slideout	77
Trouble shooting the flush floor slideout	77
Manual Operation for the flush floor slideout	77
Power Gear® Slideout	78

TABLE OF CONTENTS

<i>Fig. 1-Through Frame Crank Extension w/pin</i>	78
<i>Fig. 3-Hex Head Crank Extension</i>	78
<i>Fig. 2- Crank Handle</i>	78
<i>Fig. 4-Ratchet</i>	78
Manual Operation for the Power Gear slideout system	80
Power Gear® Slim Rack Slideout System	83
Operating the Slideout	83
<i>Fig.1 Slideout Controller</i>	83
Override Modes:	86
Emergency Retract Mode:	86
SECTION 6: ELECTRICAL SYSTEM	
The Electrical System	89
In Case Of An Electrical Fire	89
Command Center	89
<i>Command Center Panel</i>	90
<i>Command Center Panel W/Switch Modules Mounted to wall</i>	90
GFCI Receptacle	91
Handheld Wireless Remote Operation	91
Handheld Remote Control	91
Programming the handheld remote	91
<i>Handheld wireless remote control located at entrance door</i>	91
Reset the handheld remote PIN code:	92
Operating the handheld remote	92
Important remote control operating information	93
Testing the Campsite Power Connection	94
Connecting the Power Cord	95
Inverter (If so Equipped)	96
Inspection and maintenance	96
Converter	96
12-volt DC System	97
<i>Wizard Button & Reverse Protection Fuses</i>	97
12-volt Fuse Panel	98
Replacing a fuse	98
12-Volt DC Outlet	98
Auxiliary Battery (Customer Supplied)	98
Dry camping	99
Replacement and maintenance	99
Battery Isolator For Your Tow Vehicle (Customer Supplied)	100
Battery Disconnect Switch (If So Equipped)	100
<i>Battery Disconnect Switches</i>	100
<i>Switch appearance may vary by model</i>	100
Load Center	101
Approximate Electrical Load Ratings	101
<i>Typical Load Center Exterior Panel</i>	101
<i>50A Load Center Panel w/120 volt Main breaker</i>	101
120-volt (50 AMP) AC System (If So Equipped)	102
50-amp Power Cord (If So Equipped)	103
Calculating 50 AMP Electrical Load (If So Equipped)	103
120-volt Circuit Breakers	104
Generator	105

TABLE OF CONTENTS

Before starting the generator	105
To start the generator manually	106
Maintenance	106
Solar Prep (If So Equipped)	107
LED Decorative Light Strips (If So Equipped)	107
Replacing Light Bulbs	107
<i>Solar Plug</i>	107

SECTION 7: FUEL & PROPANE SYSTEM

Exhaust Gas Fumes	109
Propane Gas System	109
Propane Leak Test	110
Propane Safety Procedure	110
Maintenance	110
Propane Gas Container	111
<i>Propane system label</i>	111
Servicing or filling	112
LP gas container overfill	113
Installing Propane Cylinder(s)	114
<i>Two propane cylinders</i>	114
<i>Main supply hose</i>	114
Propane Regulator	116
Using The Propane System	116
Calculating Propane Gas Usage	117
Cooking With Propane Gas	118
<i>Ensure a supply of fresh air (Canada units only)</i>	118
<i>Cooking / comfort heating label</i>	118
Traveling with Propane	119
<i>Re-fueling Warning Label</i>	119

SECTION 8: PLUMBING SYSTEM

Plumbing System Maintenance	121
Monitor Panel (If So Equipped)	121
<i>(Monitor panel appearance and components listed may vary)</i>	121
<i>Monitor panel</i>	121
<i>Command center panel</i>	121
Fresh Water System	122
Fresh Water Holding Tank	123
12-Volt Water Pump & Switch	123
Water Pressure Regulator (customer Supplied)	124
<i>Water Pump</i>	124
Uni-Dock Utility Center (If So Equipped)	125
<i>Uni-Doc Utility Center</i>	125
<i>Potable water only label</i>	126
“POWER FILL TANK” (Pressurized fresh water source)	126
“SANITIZE” (or Siphon Fill) the Fresh Water Tank via Pump	126
“DRY CAMPING” (pump supplies water from the fresh water tank)	127
“CITY WATER” (Pressurized fresh water source)	128
“WINTERIZE” (plumbing lines and fixtures via pump)	128
Water Purification System (If So Equipped)	129
To Replace Canister Filter Cartridge	129
<i>Filter housing</i>	129
Water Heater	130
<i>Anode rod replacement chart</i>	132
Outside Shower (If So Equipped)	136

TABLE OF CONTENTS

Faucets	136
Bathroom Tub / Shower	137
Hardware & Sink or Shower Fixtures	137
Draining The Fresh Water System	138
Sanitizing the Plumbing System	138
<i>Exterior fresh water drain</i>	138
<i>Low point drain</i>	138
How to Sanitize	139
<i>Refer to Uni-Dock Utility Center for setting details and color key</i>	139
Winterizing The Plumbing System (Uni-Dock Utility Center)	142
Air Pressure Method	143
Winterize the Black Tank Flush:	144
<i>Water heater drain plug</i>	144
Winterizing with antifreeze:	145
Winterizing Appliances	146
Winterize Frigidaire Residential Refrigerator:	146
De-winterize the Frigidaire Residential Refrigerator:	147
Purge all antifreeze out of the water lines of the RV then:	147
Winterize the Samsung Residential Refrigerator:	147
De-winterizing the Samsung Residential Refrigerator:	147
Winterize RV style refrigerator:	148
Winterize Whirlpool Clothes Washer (If So Equipped):	148
De-winterizing the Whirlpool Clothes Washer:	148
Winterize Fisher Paycal Dishwasher (If So Equipped):	148
Winterize the DEHCO Dishwasher (If So Equipped):	148
Winterize a macerator toilet: (If So Equipped):	148
De-winterize the macerator toilet:	148
Black/Grey Water System	149
Black/Grey Water Holding Tanks	150
Black & Grey Tank Drains	150
Macerator Pump System (if so equipped)	151
<i>Black/Grey tank drain & valves</i>	151
<i>Macerator hose and dump connector</i>	152
<i>Garden hose connection</i>	152
Black Tank Flush (Rinsing the Waste Tank)	153
<i>Sewer Tank Flush Inlet on Utility Center</i>	153
Tank Heaters (If So Equipped)	154
Toilet	155

SECTION 9: HEATING & COOLING

Air Conditioner	157
Roof Mount (If So Equipped)	157
Wall Mount (If So Equipped)	157
Power Roof Vent (If So Equipped)	157
<i>Attic Fan Control</i>	157
Ceiling Fan (If So Equipped)	158
Ducting & Return Air	158
Furnace	158
Fireplace (If So Equipped)	159

SECTION 10: APPLIANCES

Microwave	161
Cooktops (If So Equipped)	161
Electric drop in cooktops (if so equipped)	162

TABLE OF CONTENTS

Gas drop in cooktops (if so equipped)	163
Kitchen Range & Oven (If So Equipped)	163
Gas BBQ Grill (If So Equipped)	164
<i>Bumper mounting bracket</i>	165
Attaching the “quick coupler” connection	166
<i>Gas Grill & Mounting Bracket</i>	166
<i>Quick Coupler Connection</i>	166
<i>Bracket on Support Rail</i>	166
Using the BBQ Grill	167
<i>Electric BBQ Grill</i>	167
Range Hood (If So Equipped)	168
Cooking With Propane	168
<i>Range Hood Vent</i>	168
Using the BBQ Grill Cart (if so equipped)	168
In Case Of A Grease Fire	169
Refrigerator	169
Cleaning Your Refrigerator	170
Cleaning the interior	170
Cleaning the exterior	170
Washer/Dryer Prep (If So Equipped)	171
Central Vacuum System (if so equipped)	171
<i>Dryer vent label</i>	171
Rechargeable Vacuum (If So Equipped)	172
Water Heater – See plumbing section	172

SECTION 11: ELECTRONICS

Satellite (if so equipped)	173
HDTV Antenna (If So Equipped)	173
<i>King Jack HDTV antenna</i>	173
<i>Winegard HDTV antenna</i>	173
<i>Enclosure base</i>	173
<i>Interior Base</i>	173
Exterior Sliding / Pivoting TV	174

SECTION 12: INTERIOR

Cleaning The Interior	177
Décor Items	177
Window treatments	177
Window Shades	177
Sofa	178
Hide-a-bed Sofa or Sofa Sleeper	178
Jack Knife Sofa	178
Trifold Sofa The Trifold	179
Free-Standing Table & Chairs (If So Equipped)	179
Booth Dinette (If So Equipped)	179
Cabinetry & Tables	180
Pantry or Hutch (If So Equipped)	180
Countertops	180
Laminate countertops (if so equipped)	180
Solid surface countertops (if so equipped)	181
Interior Wall Panel	181
Flooring	181
Carpet	181
Loft Sleeping Area (If So Equipped)	182
<i>Loft Sleeping Area</i>	182
<i>Ladder access to sleeping loft</i>	182

TABLE OF CONTENTS

Vinyl flooring	182
ABS Plastics	183
Floor Safe (If So Equipped)	183
SECTION 13: EXTERIOR	
<hr/>	
Cleaning The Exterior	185
Frame	187
Front Axle Tire Alignment	187
Exterior Roof & Sidewall Vents	188
Windows	188
Exterior ladder (If So Equipped)	188
Sealants	188
Fifth Wheels - Sealant Diagram	189
SECTION 14: TRAVEL/CAMPING/STORAGE CHECKLISTS	
<hr/>	
RV Start-Up	191
Ready To Leave & Maintenance Checklist	191
Maintenance Checklist	192
RV Storage	193
SECTION 15: ADDITIONAL INFORMATION	
<hr/>	
Featured Components Quick Reference Chart	195
Vehicle Maintenance Record	197



WARNING: READ ALL INSTRUCTIONS IN THIS MANUAL AND COMPONENT MANUFACTURER SUPPLIED INFORMATION BEFORE USING YOUR RV

This manual has been provided by Jayco for the sole purpose of providing instructions concerning the operation and maintenance of this vehicle and its components. Nothing in this manual creates any warranty, either expressed or implied. The only warranty offered by Jayco is as set forth in the limited warranty applicable to this vehicle.

The owner's failure to provide required service and/or maintenance could result in the loss of warranty. The owner should review the Jayco limited warranty and the limited warranties that apply to specific components that are offered with this vehicle.

Instructions are included in the manual for operating various components which are optional on some vehicles or may not be available on your particular model. **“If so equipped” does not indicate or imply that the component(s) or option(s) were at any time available, or can be retrofitted to your model.** In addition, the owner should refer to individual manufacturer's operating instructions contained in the owner's packet.

Congratulations! Thank you for selecting a Jayco recreation vehicle. We are excited to welcome you to our growing RV family. Jayco is the largest privately held manufacturer of recreation vehicles in the world. We are committed to being the most respected name in RVs. We invite you to drop by our Visitors Center located in Middlebury, Indiana. To book a group tour or check our scheduled factory tour times (free admission, closed holidays) please call 1-800-RV-JAYCO.

ABOUT THIS MANUAL

This manual is a guide to operation of the features, equipment and controls in your recreation vehicle. If you find components vary significantly from what is described, please contact your dealer to ensure you have the correct information. Nothing in this manual creates any warranty, either expressed or implied.

This Owner's Manual and Warranty Packet are to be considered permanent components of the vehicle. Keep them in your recreation vehicle at all times for personal reference. If the recreation vehicle is sold, they should remain with the vehicle for the next owner. Nothing in this manual creates any warranty, either expressed or implied, nor does it cover every possible detail of equipment, standard or option, installed on or in your recreation vehicle.

Information, illustrations and specifications in this manual reflect the most current available at the time of publication approval, are subject to change and not intended to indicate actual size.

WARRANTY PACKET

There are components that are excluded from the vehicle warranty, or are warranted separately by their own individual manufacturer's limited warranty. The Warranty Packet contains these component manufacturer supplied manuals or information sheets, warranty cards and/or registrations. Consult this information for questions regarding operating, maintenance, servicing instructions and warranty coverage. It is important you complete and mail warranty cards and registrations within the prescribed time limits to avoid loss of warranty coverage.

SAFETY ALERTS

Throughout this manual, certain items are labeled **NOTE**, **CAUTION**, **WARNING**, and **DANGER**. These terms will alert you to precautions that can involve risk to your vehicle or to your personal safety.

Read and follow them carefully. National Safety Associations and organizations require many of the instructions listed. Always use the appropriate safety gear when servicing or maintaining your recreation vehicle. Please call your dealer or our customer service representatives if you are unsure how to proceed.

These signal words indicate precautions and potential situations, which if not avoided, may result in personal injury, property damage, or damage to your recreation vehicle. These precautions are listed in the appropriate areas in this Owner's Manual, and in the information contained in the Warranty Packet, and on safety labels affixed to your recreation vehicle. Read and follow them carefully.

SECTION 1: WARRANTY & SERVICE



NOTE: Gives helpful information.



This is the safety alert symbol. It is used to alert you to potential personal injury hazards. Obey all safety messages that follow this symbol to avoid possible injury or death.

NOTICE

Indicates a potential situation that, if not avoided, may result in property damage or damage to your motor home.



CAUTION

Indicates a potentially hazardous situation that, if not avoided, may result in minor or moderate injury. It may also be used to alert against unsafe practices.



WARNING

Indicates a potentially hazardous situation that, if not avoided, may result in death or serious injury.



DANGER

Indicates an imminently hazardous situation that, if not avoided, will result in death or serious injury. This alert information is limited to the most extreme situations.

REPORTING SAFETY DEFECTS

In the United States

If you believe that your recreation vehicle has an alleged defect that could cause a crash or cause injury or death, you should immediately inform the National Highway Traffic Safety Administration (NHTSA) and Jayco.

If NHTSA receives similar complaints, it may open an investigation, and if it finds that a safety defect exists in a group of vehicles it may order a recall and remedy campaign. However, NHTSA cannot become involved in individual problems between you, your dealer or Jayco. For additional information, please refer to the NHTSA website at www.safercar.gov.

To contact NHTSA by phone:

Call the Department of Transportation (DOT) Vehicle Safety Hotline at 1-888- 327-4236

and a NHTSA representative will record your complaint information (TTY: 1-800-424-9153 or 1-202-484-5238).

To contact NHTSA by mail:

Office of Defects Investigations/CRD
NVS-216
1200 New Jersey Ave SE
Washington, DC 20590

In Canada

If you believe your recreation vehicle has an alleged safety defect, you should contact Transport Canada and Jayco. Transport Canada prefers to be called instead of posted mail or email as it enables their investigators to confirm that your information is correct, and to answer your questions accurately. For additional information, please refer to the Transport Canada website at www.tc.gc.ca.

To contact Transport Canada by phone:

Call 1-800-333-0510 (or 1-613-993-9851 if you are calling from the Ottawa region) and ask to speak to a defect investigator.

To contact Transport Canada by mail:

Road Safety and Motor Vehicle
Regulation Directorate
Transport Canada
Tower C, Place de Ville
330 Sparks Street
Ottawa, Ontario K1A 0N5

MANUFACTURING PROCESS



Jayco recreation vehicles are manufactured for use as temporary living quarters for recreation, camping and travel uses, all as defined by the bylaws of the Recreation Vehicle Industry Association (RVIA).

This recreation vehicle is not intended for use as a full-time residence or for commercial use. Commercial use means using the recreation vehicle as a business asset such as a mobile office or using the recreation vehicle for lease or rental purposes.

Jayco reserves the right to discontinue or change specifications or design at any time without notice and without incurring any obligation whatsoever. Recreation vehicles built for sale in Canada may differ to conform to Canadian Codes.

OPTIONS & EQUIPMENT

Jayco recreation vehicles are available in several sizes and models, so accessories and components may differ slightly between models. Some equipment described in this manual may not apply to your recreation vehicle.

Jayco reserves the right to discontinue or change specifications or design at any time without notice, and to make additions or improvements without incurring any obligations upon itself to install these changes on its products previously manufactured. Recreation vehicles built for sale in Canada may differ to conform to Canadian Codes.

SECTION 1: WARRANTY & SERVICE

CUSTOMER RESPONSIBILITY

It is important you read and understand all instructions and precautions before operating the recreation vehicle. Even if you are an experienced RV'er we encourage you to thoroughly read this Owner's Manual, as well as the information contained in your Warranty Packet.

As technology advances, new improvements enter the RV industry every day, and each RV manufacturer has its own unique manufacturing process.

Familiarize yourself with the applicable warranties. There are components that are excluded or warranted separately by their individual manufacturer's limited warranty (refer to the Warranty Packet).

As the owner of the recreation vehicle, you are responsible for regular and proper maintenance performed in accordance with this manual and the OEM manuals. Regular and proper maintenance will help prevent conditions arising from neglect that are not covered by warranty. It is your responsibility and obligation to return your recreation vehicle to your dealer for warranty service repair.

CHANGE OF ADDRESS/OWNERSHIP

Please notify Jayco Customer Service as soon as possible of a change of address by writing or calling us. For notification of a change of ownership, please fill out the appropriate form located in this manual and mail it to Jayco Customer Service along with documentation showing proof of ownership. Please include your current vehicle mileage (motorized only).

DEALER RESPONSIBILITY

At the time of sale of the new recreation vehicle, your Jayco dealer is expected to:

- Deliver your recreation vehicle in the best condition possible. Your recreation vehicle must pass the dealer's pre-delivery inspection (PDI), including all systems tests.
- Provide orientation of the recreation vehicle, its systems, components and operation.
- Request that you read all warranty information and explain any provision not clearly understood.
- Ensure you receive the Warranty Packet. Your dealer can assist you in completing the OEM warranty cards or registrations, and locate any required component model or serial numbers.
- Complete and return the "Warranty Registration and Customer Delivery Form" to Jayco within 10 days of delivery to activate the applicable warranty coverage.

The **Limited Warranty** is activated only after Jayco receives a signed and dated "Warranty Registration and Customer Delivery Form" from your dealer.

SUGGESTIONS FOR OBTAINING SERVICE

To help ensure your dealer provides the level of service you expect, here are some suggestions we would like to make:

Contact your dealer at once... Do not wait until you are ready to use your RV. Your dealer may not be able to service it immediately and/or the repair may require parts be ordered. The dealer's service department is busiest on Mondays, Fridays and before the holidays.

Prepare for the appointment... If you are having warranty work performed, be sure to have the right papers with you. Take your warranty folder and have your vehicle information available. All work to be performed may not be covered by the warranty. Discuss additional charges with the service personnel.

Prepare a list... Provide your dealer with a written list of specific repairs needed. It is important that you provide any vehicle repair history to the dealer's service personnel.

Keep a maintenance log of your vehicle's service history. This can often provide a clue to the current issue.

Be reasonable with your requests... If you leave a list with several items and you need your vehicle returned back by a specific time, discuss the situation with the dealer's service personnel and list your items in order of priority. This may include making a second appointment for work not completed or parts that the dealer may need to order.

Don't expect to look over the technician's shoulder... Please don't be offended if you are told you cannot watch the work being done. Some insurance requirements forbid admission of customers to the service area.

Inspect the work performed... Finally, check out the service or repair job when you pick up your vehicle. Notify the dealer's service personnel immediately of any dissatisfaction. If you cannot return the vehicle immediately for repair, make an appointment as soon as possible.

Please be aware that all service shops require notification of any issues with their repairs within a specified time limit. Make sure you are familiar with their repair policies.

CUSTOMER RELATIONS

Jayco has empowered its dealers to make warranty and repair decisions.

If a special circumstance occurs that requires information from Jayco, we have asked your dealer's service management to make the contact on your behalf. This is why you should always talk to your dealer's service management first.



NOTE: Please provide the following information when contacting us for assistance:

- Customer name and current location.
- Phone number where you can be reached.
- 17-digit chassis Vehicle Identification Number (VIN) or 9-digit Serial
- The current vehicle mileage (motor homes)
- Your date of purchase.
- If applicable, the component description, serial number and model number.
- A detailed description of the concern.

The name of your selling dealer.

If different from above, the contact information for the RV repair facility you are contacting Jayco to discuss.

SECTION 1: WARRANTY & SERVICE

Mailing address

Jayco, Inc.
Customer Service
P.O. Box 460
903 S. Main Street
Middlebury IN 46540
Phone (toll-free)
Phone (local)
Fax (toll-free)
Brochure request
Parts email
Service email
Website

Shipping address

Jayco, Inc.
Customer Service
100 Bontrager Drive
Bldg 42 Door 4220
Middlebury IN 46540
(800) 283-8267
(574) 825-0608
(866) 709-9139
info@Jayco.com
parts@Jayco.com
service@Jayco.com
www.Jayco.com

An important note about alterations and warranties

Installations or alterations to the original equipment vehicle as distributed by Jayco are not covered by the Jayco Limited Warranty. The special body company, assembler, equipment installer or up fitter is solely responsible for warranties on the body or equipment and any alterations (or any effect of the alterations) to any of the parts, components, systems or assemblies installed by Jayco. Jayco is not responsible for the safety or quality of design features, materials or workmanship of any alterations by such suppliers.

JAYCO TRAVEL CLUB

All owners of Jayco recreation vehicles are eligible for membership in the Jayco Travel Club. The club promotes family camping and the active use of your RV with others who have similar interests in the RV lifestyle.



One "International Rally" is held each year in various locations around the United States and Canada. In addition, the club offers a variety of local and regional activities throughout the year.

By belonging to the Jayco Travel Club, you will find new ways to enjoy your RV and make friends all across the country.

For more information, please visit www.Jaycorvclub.com or call 1-800-262-5178.

JAYPLUS™ EXTENDED SERVICE CONTRACT

Don't let unexpected repair costs keep you from traveling toward your dreams. Protect yourself with a JayPlus™ Extended Service Agreement. For more information, contact your dealer or call 1-800-527-3426.



Your dealer can help you obtain a JayPlus™ insurance quote from GMAC Insurance or call 1-877-484-2261 (Savings Code: GL 2A).

JAYCO CUSTOMER FIRST EMERGENCY ROADSIDE ASSISTANCE

Jayco has teamed up with Coach Net, the largest RV emergency road service in the country to give you 24 hour, 7 days a week assistance in obtaining dependable service when and where you need it. We are offering this free of charge for the first year of ownership from the date of purchase (*certain restrictions apply**).

You may continue your Customer First Roadside Assistance benefits in the following years

by contacting Coach Net to discuss any applicable terms and rates for this independently continued coverage at 1-877-801-0333.

For further details and instructions on how to access your Roadside Assistance benefits, please refer to your *Member Benefit Guide* which will be mailed 6-8 weeks from the date the completed *Warranty Registration and Customer Delivery Form* is received by Jayco, or by contacting Coach-Net (www.coach-net.com) at 1-877-801-0333.

*To qualify for coverage, your RV must be eligible as set forth under the terms of the applicable "Limited Warranty" offered by Jayco.

OBTAINING EMERGENCY WARRANTY REPAIR

A roadside emergency can happen at any time, whether your recreation vehicle is new or old. If you are traveling, using the following guidelines can help get you back on the road faster.

1. Call 1-800-RV-JAYCO or use our website dealer locator to find an authorized Jayco dealer in your area. Contact them for an appointment; they will handle all warranty repair billing and returned parts for you.
2. If you cannot locate an authorized Jayco dealer near you, ask the campground staff for referrals or check the local telephone yellow pages. Or contact Jayco Customer Service or your selling dealer for assistance in locating a repair facility.
 - a. Contact the RV repair facility to discuss your situation and make an appointment. Ask how their billing will be handled. They may choose to bill Jayco directly; otherwise, you are expected to pay them.
 - b. Have the RV repair facility inspect your RV. Either they or you must call Jayco Customer Service to discuss applicable warranty coverage prior to any repair work being performed.
 - c. Jayco Customer Service will issue an authorization number upon warranty repair approval and advise if any original parts need to be returned.
 - d. Once Jayco Customer Service has issued an authorization number, the RV repair facility may begin actual repair to your RV.
 - e. Inspect the completed repair work thoroughly. If you are not satisfied, communicate that immediately to the RV repair facility management. Make sure you are satisfied with the repair before you pay or leave the premises.
 - f. For reimbursement, either you or the RV repair facility must send a copy of your itemized repair bill and all requested return parts by UPS (regular ground, freight pre-paid) within 60 days of the completed repair date.

To expedite processing your warranty claim, include your name, address, phone number, RV 17-digit VIN and authorization number. If returning parts, include a copy of your return freight bill.

Obtaining weekend or after business hours repair assistance

If an authorized Jayco dealer is not located nearby, contact your selling dealer for assistance. If your dealer is closed, check with the campground staff or telephone yellow pages for an RV repair facility. Have the item repaired and contact Jayco Customer Service immediately the following business day.

Failure to contact Jayco Customer Service, unauthorized or improper warranty repairs, or failure to return requested original parts may result in loss of reimbursements and/or loss of warranty.

SECTION 1: WARRANTY & SERVICE

OBTAINING SERVICE FOR SEPARATELY WARRANTED ITEMS

Your selling dealer is responsible for servicing your recreation vehicle before delivery, and has an interest in your continued satisfaction. We recommend your dealer perform all inspection, warranty and maintenance services. Some dealers may be authorized service centers for those OEMs whose products are warranted separately and excluded from the **Limited Warranty**.

OBTAINING SERVICE AT JAYCO

Should your RV be in need of service, and your dealer recommend that the repairs be made at the Jayco Factory Service Center, your RV may be returned to us with the following guidelines*:

- You or your dealer must make a confirmed appointment a minimum of **60 days** prior to dropping off your RV at the Jayco Factory Service Center.
- The holding tanks must be emptied and rinsed. We have a dumping station available for customer use.
- The propane system and all electrical systems must be shut down and turned off. We are not responsible for discharged batteries or propane tanks.
- During the appropriate season, please ensure your RV is winterized.
- Unless prior approval has been obtained from the Jayco Factory Service Center, all personal items must be removed from the area where you are requesting service repair and the refrigerator emptied. We are not responsible for loss of food items.
- All transportation costs are the responsibility of the owner. You may need to arrange for alternative accommodations for some types of repairs. Please be prepared accordingly.
- *Jayco Customer Service occasionally utilizes local independent repair facilities. Your RV may be referred to or repaired by one of these local repair facilities.

PARTS & ACCESSORIES

Contact your independent Jayco dealer for assistance in obtaining replacement parts or accessories. Jayco does not sell parts retail direct or to non-authorized dealers. If the original part is no longer available, Jayco makes every effort to provide an appropriate substitute.

TOWABLE LIMITED WARRANTY

WHAT AND WHO IS COVERED

The Jayco warranty covers this recreational vehicle (“RV”), when used only for its intended purpose of recreational travel and camping, for two (2) years. It covers RV’s that are sold in, and remain in, the United States, U.S. Territories and Canada, only. The warranty period begins on the date that the RV is delivered to the first retail purchaser by an independent, authorized dealer of Jayco, or, if the dealer places the vehicle in service prior to retail sale, on the date the RV is first placed in such service. In the event that a substantial defect in material or workmanship, attributable to Jayco, is found to exist during the warranty period, it will be repaired or replaced, at Jayco’s option, without charge to the RV owner, in accordance with the terms, conditions and limitations of this limited warranty.

This limited warranty applies to the first consumer purchaser only. All rights and limitations within this warranty are applicable to the original owner of the RV only. Jayco’s limited warranty only covers substantial defects in materials, components, or parts of the RV attributable to Jayco. It does not replace, modify, or apply to the warranties provided by the

manufacturers that supply the products used by Jayco to assemble the RV, like the frame. You may contact an independent, authorized dealer for details.

Jayco's obligation to repair or replace defective materials or workmanship is the sole obligation of Jayco under this limited warranty. Jayco reserves the right to use new or remanufactured parts of similar quality to complete any work, and to make parts and design changes from time to time without notice to anyone. Jayco reserves the right to make changes in the design or material of its products without incurring any obligation to incorporate such changes in any product previously manufactured. Jayco makes no warranty as to the future performance of this RV, and this limited warranty is not intended to extend to the future performance of this RV, or any of its materials, components or parts. In addition, the RV owner's obligation to notify Jayco, or one of its independent, authorized dealers, of a claimed defect does not modify any obligation placed on the RV owner to contact Jayco directly when attempting to pursue remedies under state or federal law.

LIMITATIONS, EXCLUSIONS AND DISCLAIMER OF IMPLIED WARRANTIES

ANY IMPLIED WARRANTY THAT IS FOUND TO ARISE BY WAY OF STATE OR FEDERAL LAW, INCLUDING ANY IMPLIED WARRANTY OF MERCHANTABILITY OR ANY IMPLIED WARRANTY OF FITNESS, IS LIMITED IN DURATION TO THE DURATION SET FORTH IN THIS LIMITED WARRANTY AND IS LIMITED IN SCOPE OF COVERAGE TO THE SCOPE OF COVERAGE OF THIS LIMITED WARRANTY.

Jayco makes no warranty of any nature beyond that contained in this limited warranty. Jayco does not authorize any person to create any other obligation or liability for it regarding this RV, and Jayco is not responsible for any representation, promise or warranty made by any dealer or other person beyond what is expressly stated in this limited warranty, and no one has the authority to enlarge, amend or modify this limited warranty. Any selling or servicing dealer is not Jayco's agent, but an independent entity.

JAYCO SHALL NOT BE LIABLE FOR ANY INCIDENTAL OR CONSEQUENTIAL DAMAGES THAT MAY RESULT FROM BREACH OF THIS LIMITED WARRANTY OR ANY IMPLIED WARRANTY.

THIS EXCLUSION OF CONSEQUENTIAL AND INCIDENTAL DAMAGES SHALL BE INDEPENDENT OF ANY FAILURE OF THE ESSENTIAL PURPOSE OF ANY WARRANTY, AND THIS EXCLUSION SHALL SURVIVE ANY DETERMINATION THAT THIS LIMITED WARRANTY OR ANY IMPLIED WARRANTY HAS FAILED OF ITS ESSENTIAL PURPOSE.

Some states do not allow limitations on how long an implied warranty lasts, or the exclusion or limitation of incidental or consequential damages, so the above limitations or exclusions may not apply to you.

HOW TO GET SERVICE

To obtain warranty service the owner must do all of the following:

1. Notify an independent, authorized dealer of Jayco, or Jayco, of the substantial defect in material or workmanship attributable to Jayco, within the warranty coverage period designated above;
2. Provide the notification mentioned in (1), above, within ten (10) days of when the owner discovered, or should have discovered, the substantial defect in material or workmanship attributable to Jayco;

SECTION 1: WARRANTY & SERVICE

3. Promptly schedule an appointment with and take the RV to an independent, authorized dealer of Jayco, or Jayco, for repairs; and
4. Pay any freight or transportation costs, import duties, fees and all incidental expenses associated with obtaining warranty service.

For warranty service simply contact one of Jayco's independent, authorized service centers for an appointment and then deliver your RV to the service center on the specified appointment date. If you need assistance you may contact Jayco, at 903 S. Main Street, P.O. Box 460, Middlebury, Indiana 46540, Attn: Customer Service, (574) 825-5861, (800) 283-8267 or www.jayco.com.

NOTE: Jayco does not control the scheduling of service work at the independent, authorized dealerships. You may encounter some delay in scheduling or completion of work. Also, you must notify the selling dealer at time of delivery to have work performed on any defect that occurred at the factory during manufacture at no cost to you as provided by this limited warranty. (See below under WHAT IS NOT COVERED).

If two (2) or more service attempts have been made to correct any covered defect that you believe impairs the value, use or safety of the RV, or if it has taken longer than thirty (30) days for those types of repairs to be completed, you must, to the extent permitted by law, notify Jayco directly, in writing, at the above address, of the unsuccessful repair(s) of the alleged defect(s) so that Jayco can become directly involved in making sure that you are provided service pursuant to the terms of this limited warranty.

WHAT IS NOT COVERED

By way of example only, this limited warranty does not cover any of the following: defects in materials, components or parts of the RV not attributable to Jayco; items that are added or changed after the RV leaves the possession of Jayco; additional equipment or accessories installed at any dealership, or other place of business, or by any other party, other than Jayco; any RV used for rental or other commercial purposes (Note: It shall be concluded that the RV has been used for commercial and/or business purposes if the RV owner or user files a tax form claiming any business or commercial tax benefit related to the RV, or if the RV is purchased, registered or titled in a business name); any RV sold or used outside the United States, U.S. Territories or Canada; any RV not used solely for recreational travel and camping; any RV purchased through auction or wholesale; any RV purchased from a dealer that is not an authorized dealer of Jayco; normal wear, tear or usage, such as tears, punctures, soiling, mildew, fading, or discoloration of exterior plastic or fiberglass, or soft goods, such as upholstery, drapes, carpet, vinyl, screens, cushions, mattresses and fabrics; the effects of condensation or moisture from condensation inside the RV or failure to provide adequate ventilation; mold or any damage caused by mold to the inside or outside of the RV; imperfections that do not affect the suitability of the RV for its intended purpose of recreational use or items that are working as designed but that you are unhappy with; problems, including water leaks, related to misuse, mishandling, neglect or abuse, including failure to maintain the RV in accordance with the owner's manual, or other routine maintenance such as inspections, lubricating, adjustments, tightening of screws and fittings, tightening of lug nuts, sealing, rotating tires; damage due to accident, whether or not foreseeable, including any acts of weather or damage or corrosion due to the environment, theft, vandalism, fire, or other intervening acts not attributable to Jayco; service items such as windshield wiper blades, lubricants, fluids, filters, etc.; damage resulting from tire wear or tire failure; defacing, scratches, dents, chips on any surface or fabric of the RV; damage

caused by off road use, overloading the RV or alteration of the RV, or any of its components or parts; wheel alignment or adjustments to axles when caused by improper maintenance, loading or damage from road hazards, including off road travel, wheel damage or balancing or damage from tire failures. Also, any costs associated with obtaining service, including by way of example, travel costs, are specifically excluded from the coverage of this warranty.

In addition, this limited warranty does not cover any material, component or part of the RV that is warranted by another entity, including, by way of example, handling, braking, wheel balance, muffler, tires, tubes, batteries, gauges, generator, hydraulic jacks, inverter, converter, microwave, television, DVD/CD player, radio, speakers, television, refrigerator, range, hot water heater, water pump, stove, carbon monoxide detector, smoke detector, propane detector, furnace or any air conditioner. (Note: The written warranty provided by the manufacturer of the component part is the direct responsibility of that manufacturer).

Defects and/or damage to interior and exterior surfaces, trim, upholstery and other appearance items may occur at the factory. These items are usually detected and corrected at the factory or by the selling dealer prior to delivery to the retail customer. You must inspect your RV for this type of damage when you take delivery. If you find any such defect or damage you must notify the selling dealer at time of delivery to have these items covered by this limited warranty and to have work performed on the items at no cost to you as provided by this limited warranty.

EVENTS DISCHARGING JAYCO FROM OBLIGATION UNDER WARRANTY

Certain things completely discharge Jayco from any obligation under this warranty and void it. By way of example, the following shall discharge Jayco from any express or implied warranty obligation to repair or replace any defect that results from: any rental or other commercial use or purchase of the RV (as defined in this warranty), any RV sold outside of, or used outside of, the United States, U.S. Territories or Canada, through an auction or wholesale or by a non-authorized dealer, any defect in a separately manufactured component part, owner neglect or failure to provide routine maintenance (See Owner's Manual), unauthorized alteration, off road use, collision or accident, whether or not foreseeable, including any acts of weather or damage or corrosion due to the environment, theft, vandalism, fire, explosions, overloading in excess of weight ratings, and tampering with any portion of the RV, or any use of the RV as a semi-permanent or permanent home.

LEGAL REMEDIES

Any action to enforce any portion of this limited warranty, or any implied warranty, shall be commenced within six (6) months after expiration of the warranty coverage period designated above. Any performance of repairs shall not suspend this limitation period from expiring. Any performance of repairs after the warranty coverage period has expired, or performance of repairs regarding anything excluded from coverage under this limited warranty shall be considered "good will" repairs, and they will not alter the express terms of this limited warranty, or extend the warranty coverage period or this limitation period. In addition, this warranty is not intended to extend to future performance, and nothing in this warranty, or any action of Jayco, or any agent of Jayco, shall be interpreted as an extension of the warranty period or this limitation period. Some states do not allow a reduction in the statute of limitations, so this reduction may not apply to you.

WARRANTY REGISTRATIONS

Your warranty registration records should be completed and delivered to the

SECTION 1: WARRANTY & SERVICE

manufacturers of component parts. The selling dealership will assist you in completing and submitting the Jayco product warranty registration form. That form must be returned to Jayco within ten (10) days of your taking delivery of the RV. Your Jayco warranty will not be registered unless this warranty registration is completed and received by Jayco. Failure to file this warranty registration with Jayco will not affect your rights under this limited warranty as long as you can present proof of purchase, but it can cause delays in obtaining the benefits of this limited warranty, and it may inhibit any servicing facility's ability to provide proper repairs and/or part replacement.

CARE AND MAINTENANCE

It is the owner's responsibility to perform proper care and maintenance of the RV, and to assure correct load distribution. For details regarding this, please see your Jayco owner's manual and the owner's manuals of the chassis manufacturer and other component part manufacturers. These outline various care and maintenance that is required to maintain your RV. Please review all manuals supplied with your RV, and contact your selling dealership or supplier of the component part if you have questions. Note: Failure to maintain the RV as noted in those manuals voids this limited warranty, and any damage to the RV as a result of your failure to perform such care, is not covered by this limited warranty.

THIS WARRANTY GIVES YOU SPECIFIC LEGAL RIGHTS, AND YOU MAY ALSO HAVE OTHER RIGHTS THAT VARY FROM STATE TO STATE.

JAYCO, INC.

903 S. Main Street * P.O. Box 460 * Middlebury, IN 46540

Telephone: 574-825-5861 or 800-283-8267

NOTICE TO JAYCO DEALERS

This Owner's Manual contains the *Towable Limited Warranty* that applies to this RV. However, if the Jayco dealer decides to use this RV for rental purposes, then the *Towable Limited Warranty* will not apply to this RV. The *Towable Limited Rental Warranty* applies in that situation.

If, on the other hand, the Jayco dealer sells this RV to a retail customer then the rental warranty would not be applicable. **The rental warranty does not apply to retail consumers.**

Jayco's rental program is applicable to the following product lines:

- Jay Sport Camping Trailers
- Jay Feather Hummingbird TT
- Jay Feather Travel Trailers
- Jay Feather 7 Travel Trailers
- White Hawk Travel Trailers
- Jay Flight Travel Trailers
- Jay Flight SLX Travel Trailers
- Jay Flight Bungalow Travel Trailers
- Eagle Travel Trailers
- Eagle Fifth Wheels
- Eagle HT Fifth Wheels
- Eagle HT Travel Trailer
- Designer FW
- North Point FW
- Pinnacle Fifth Wheels

- Octane Toy Haulers
- Seismic Fifth Wheel Toy Haulers
- Seismic Wave Fifth Wheel Toy Haulers

If you have any questions regarding this, please contact Jayco Customer Service at (800) 283-8267 or (574) 825-0608.

JAYCO TOWABLE RENTAL LIMITED WARRANTY

WHAT AND WHO IS COVERED

The Jayco warranty covers this recreational vehicle (“RV”), when used only for recreational travel and camping, including recreational travel and camping by renters of the Dealer, for one (1) year. This limited warranty applies to the original Dealer only, and it is not transferable. The warranty period begins on the date that Dealer first places the RV in rental service. In the event that a substantial defect in material or workmanship, attributable to Jayco, is found to exist during the warranty period, Jayco will reimburse the Dealer either the reasonable costs of repair or the reasonable costs of replacement of the defect, (Jayco’s option), in accordance with the terms, conditions and limitations of this limited warranty.

Jayco’s obligation to reimburse Dealer for the reasonable costs of repair or replacement of defective materials or workmanship is the sole obligation of Jayco under this limited warranty. Jayco reserves the right to use new or remanufactured parts of similar quality to complete any work, and to make parts and design changes from time to time without notice to anyone. Jayco reserves the right to make changes in the design or material or its products without incurring any obligation to incorporate such changes in any product previously manufactured. Jayco makes no warranty as to the future performance of this RV, and this limited warranty is not intended to extend to the future performance of this RV, or any of its materials, components or parts. In addition, the Dealer’s obligation to notify Jayco, of a claimed defect does not modify any obligation placed on the Dealer to contact Jayco directly when attempting to pursue remedies under state or federal law.

LIMITATIONS, EXCLUSIONS AND DISCLAIMER OF IMPLIED WARRANTIES

ANY IMPLIED WARRANTY THAT IS FOUND TO ARISE BY WAY OF STATE OR FEDERAL LAW, INCLUDING ANY IMPLIED WARRANTY OF MERCHANTABILITY OR ANY IMPLIED WARRANTY OF FITNESS, IS LIMITED IN DURATION TO THE DURATION OF THIS LIMITED WARRANTY AND IS LIMITED IN SCOPE OF COVERAGE TO THE SCOPE OF COVERAGE OF THIS LIMITED WARRANTY.

Jayco makes no warranty of any nature beyond that contained in this limited warranty. Jayco does not authorize any person to create any other obligation or liability for it regarding this RV, and Jayco is not responsible for representation, promise or warranty made by any dealer or other person beyond what is expressly stated in this limited warranty, and no one has the authority to enlarge, amend or modify this limited warranty. Any selling or servicing dealer is not Jayco’s agent, but an independent entity.

JAYCO SHALL NOT BE LIABLE FOR ANY INCIDENTAL OR CONSEQUENTIAL DAMAGES THAT MAY RESULT FROM BREACH OF THIS LIMITED WARRANTY OR ANY IMPLIED WARRANTY. THIS EXCLUSION OF CONSEQUENTIAL AND INCIDENTAL DAMAGES SHALL BE INDEPENDENT OF ANY FAILURE OF THE ESSENTIAL PURPOSE OF ANY WARRANTY, AND THIS EXCLUSION SHALL SURVIVE ANY

SECTION 1: WARRANTY & SERVICE

DETERMINATION THAT THIS LIMITED WARRANTY OR ANY IMPLIED WARRANTY HAS FAILED OF ITS ESSENTIAL PURPOSE.

Some states do not allow limitations on how long an implied warranty lasts, or the exclusion or limitation of incidental or consequential damages, so the above limitations or exclusions may not apply to you.

HOW TO GET SERVICE

To obtain reimbursement of warranty service the owner must do all of the following:

Notify Jayco of the substantial defect in material or workmanship attributable to Jayco, within the warranty coverage period;

1. Provide the notification mentioned in (1), above, within ten (10) days of when the owner discovered, or should have discovered, the substantial defect in material or workmanship attributable to Jayco;
2. Promptly and appropriately make the necessary repairs; and
3. Pay any freight or transportation costs, import duties, fees and all incidental expenses associated with obtaining warranty service.

If you need assistance you may contact Jayco, at 903 S. Main Street, P. O. Box 460, Middlebury, Indiana, 46540, Attn: Customer Service (574) 825-5861, (800) 283-8267 or www.jayco.com. Also, you must notify Jayco within three (3) days of delivery to you to have work performed on any defect or damage to appearance items that occurred at the factory during manufacturer or during delivery at no cost to you as provided by this limited warranty. (See below under **WHAT IS NOT COVERED**).

If two (2) or more service attempts have been made to correct any covered defect that you believe impairs the value, use or safety of the RV, or if it has taken longer than thirty (30) days for those types of repairs to be completed, you must, to the extent permitted by law, notify Jayco directly, in writing, at the above address, of the unsuccessful repair(s) of the alleged defect(s) so that Jayco can become directly involved in making sure that you are provided service pursuant to the terms of this limited warranty.

WHAT IS NOT COVERED

By way of example, only, this Limited Warranty does not cover any of the following: defects in materials, components or parts of the RV not attributable to Jayco; items that are added or changed after the RV leaves the possession of Jayco; additional equipment or accessories installed at any dealership, or other place of business, or by any other party, other than Jayco; any RV not used solely for recreational travel and camping; all soft goods, normal wear, tear or usage, such as tears, punctures, soiling, mildew, fading, or discoloration of exterior plastic, fiberglass, upholstery, drapes, carpet, vinyl, screens, cushions, mattresses and fabrics; the effects of condensation or moisture from condensation inside the RV and failure to provide adequate ventilation; mold or any damage caused by mold to the inside or outside of the RV; imperfections that do not affect the suitability of the RV for its intended purpose of recreational use or items that are working as designed but that you are unhappy with; problems related to misuse, mishandling, neglect or abuse, including failure to maintain the RV in accordance with the owner's manual, or other routine maintenance such as inspections, lubricating, adjustments, tightening of screws, tightening of lug nuts, sealing, rotating tires; damage due to accident, whether or not foreseeable, including any acts of weather or damage or corrosion due to the environment, theft, vandalism, fire, or other intervening acts not attributable to Jayco; service items such as windshield wiper blades, lubricants, fluids, filters, etc.; damage resulting from tire wear

or tire failure; defacing, scratches, dents, chips on any surface or fabric of the RV; damage caused by off road use, overloading the RV or alteration of the RV, or any of its components or parts.

In addition, this limited warranty does not cover any material, component or part of the RV that is warranted by another entity, including, by way of example, handling, braking, wheel balance, muffler, tires, tubes, batteries, gauges, generator, hydraulic jacks, inverter, converter, microwave, television, DVD/CD player, radio, speakers, television, refrigerator, range, hot water heater, water pump, stove, carbon monoxide detector, smoke detector, propane detector, furnace or any air conditioner. (Note: the written warranty provided by the manufacturer of the component part is the direct responsibility of that manufacturer).

Defects and/or damage to interior and exterior surfaces, trim, upholstery and other appearance items may occur at the factory or during delivery of the RV to you. These items are usually detected and corrected at the factory. You must inspect the RV for this type of damage when you take delivery from Jayco. If you find any such defect or damage you must notify Jayco within three (3) days of delivery of the RV to you to have these items covered by this limited warranty and to have work performed on the items covered by this limited warranty.

EVENTS DISCHARGING JAYCO FROM OBLIGATION UNDER WARRANTY

Certain things completely discharge Jayco from any obligation under this warranty and void it. By way of example, the following shall discharge Jayco from any express or implied warranty obligation to repair or replace any defect that results from: any defect in a separately manufactured component part, any neglect or failure to provide routine maintenance by you or anyone you rent the RV to (See Owner's Manual), unauthorized alteration, off road use, collision or accident, whether or not foreseeable, including any acts of weather or damage or corrosion due to the environment, theft, vandalism, fire, explosions, overloading in excess of weight ratings, and tampering with any portion of the RV.

LEGAL REMEDIES

Any action to enforce any portion of this limited warranty, or any implied warranty, shall be commenced within six (6) months after expiration of the warranty coverage period designated above. Any performance of repairs shall not suspend this limitation period from expiring. Any performance of repairs after the warranty coverage period has expired, or performance of repairs regarding any thing excluded from coverage under this limited warranty shall be considered "good will" repairs, and they will not alter the express terms of this limited warranty, or extend the warranty coverage period or this limitation period. In addition, this warranty is not intended to extend to future performance, and nothing in this warranty, or any action of Jayco, or any agent of Jayco, shall be interpreted as an extension of the warranty or this limitation period. Some states do not allow a reduction in the statute of limitations, so this reduction may not apply to you.

WARRANTY REGISTRATIONS

Your warranty registration records should be completed and delivered to the manufacturers of component parts. The Jayco product warranty registration form must be returned to Jayco within ten (10) days of your taking delivery of the RV. Your Jayco warranty will not be registered unless this warranty registration is completed and received by Jayco. Failure to file this warranty registration with Jayco will not affect your rights under this limited warranty as long as you can present proof of purchase, but it can cause delays in obtaining the benefits of this limited warranty, and it may inhibit any servicing facilities'

SECTION 1: WARRANTY & SERVICE

ability to provide proper repairs and/or part replacement.

CARE AND MAINTENANCE

It is your responsibility to perform proper care and maintenance of the RV, and to assure correct load distribution. For details regarding this, please see your Jayco owner's manual and other component part manufacturers. These outline various care and maintenance that is required to maintain your RV. Please review all manuals supplied with the RV, and contact Jayco or the supplier of the component part if you have questions. Note: failure to maintain the RV as noted in those manuals voids this limited warranty, and any damage to the RV as a result of your failure to perform such care, is not covered by this limited warranty.

THIS WARRANTY GIVES YOU SPECIFIC LEGAL RIGHTS, AND YOU MAY ALSO HAVE OTHER RIGHTS THAT VARY FROM STATE TO STATE.

JAYCO, INC.

903 S. Main Street * P.O. Box 460 * Middlebury, IN 46540

Telephone: 574-825-5861 or 800-283-8267

SECONDARY MEANS OF ESCAPE (EXIT WINDOW)

Your recreation vehicle has been equipped with a window(s) that serves as a secondary means of escape. The window(s) will allow a quick exit from the vehicle during an emergency if access to the main entrance door is not available. It is easily identified by the red latches and label.

Do not remove the following label from your recreation vehicle:



Exit Window Label

When parking your recreation vehicle, make sure the egress window is not blocked by trees or other obstacles. Make sure the ground below the window is solid and can be used as an escape path.

Practice opening the window before an emergency occurs, and make sure all occupants know how to operate it:

The egress window(s) must be locked during transit.

Your recreation vehicle may be equipped with one of the following exit window styles.

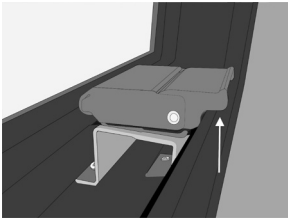

Flip latch style (2 per window)

Push up on the front lip of the latch and the latch unfolds.

Push up on the front lip of the latch again to unhook the latch from the window.

When both latches are released, push out on the window which is hinged at the top. Exit the vehicle.

The screen does not need to be removed from the window.

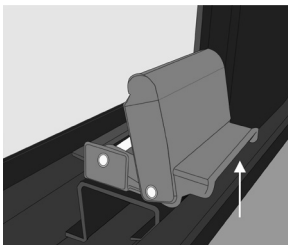

SECTION 2: OCCUPANT SAFETY

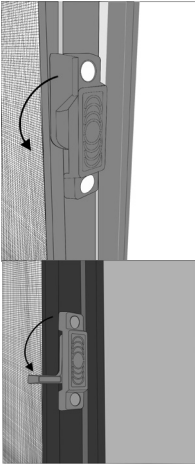

Slider window latch style

Pull the lever down to unlock the window. Slide the window to the right to open and exit the vehicle. The screen does not need to be removed from the window.

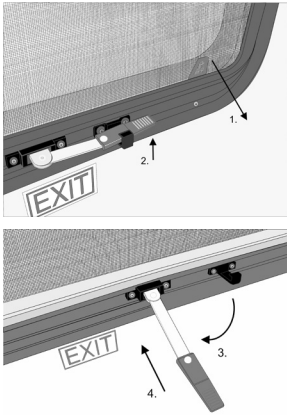

Lever style latch

Remove the screen by pulling the red tab (upper right arrow). Pull the lever out from the sash clamps. Swing the lever out so it is positioned straight out from the window. Push the lever (and window) out to open and exit the vehicle.

FIRE SAFETY

If a fire does start, follow these basic safety rules:

1. Have everyone evacuate the vehicle immediately.
2. After everyone is clear and accounted for, check the fire to see if you can attempt to put it out.
3. If it is large, or the fire is fuel-fed, get clear of the vehicle and have the Fire Department handle the emergency.
4. Do not attempt to use water to put out the fire. Water can spread some types of fire, and electrocution is possible with an electrical fire.

Refer to the following sections for additional fire safety information.

- Electrical Systems**, In case of an electrical fire.
- Appliances**, In case of a grease fire.

FIRE EXTINGUISHER

Fire extinguishers are classified and rated by fire type, A, B and C. These classifications identify the kinds of fires or burning materials they are designed to fight.

Class A - Solid materials such as wood, paper, cloth, rubber and some plastics.

Class B - Liquids such as grease, cooking oils, gasoline, kerosene or other flammable liquids.

Class C - Electrical such as electrical wires or other live electrical equipment.

A dry chemical fire extinguisher has been installed by the entrance door. It is suitable for extinguishing small fires of the Class B or C type only.

We suggest you become thoroughly familiar with the operating instructions displayed on the side of the fire extinguisher.



NOTE: For information on how to use your Fire extinguisher, refer to the Fire extinguisher user's manual provided by the Fire extinguisher manufacturer.

Inspection and maintenance

Read and follow all instructions on the label and user's manual provided by the fire extinguisher manufacturer.

Inspect the extinguisher at least once a week (more frequently if it is exposed to weather or possible tampering). This should also be done before beginning a vacation or during an extended trip.

WARNING

Do not check the pressure, test or practice using the Fire extinguisher by squeezing the trigger, even briefly. The Fire extinguisher is not rechargeable or refillable. Once used, it will gradually lose pressure and will not be fully charged for use in an emergency.

DANGER

Do not turn the electrical power back on or plug in any appliances after the use of a Fire extinguisher. Please refer to the Fire extinguisher's user manual for further instructions on maintenance and clean up.

SMOKE ALARM

The smoke alarm in your vehicle is listed for use in recreation vehicles. They only work properly if they are operational and maintained. They have a limited life and will wear out over time. Immediately replace the detector if it is not working properly, if it displays any type of problem, or within five years of use. **Be sure to read, understand and follow the**

SECTION 2: OCCUPANT SAFETY

information provided by the smoke alarm manufacturer, including information on the limited life of smoke alarms.

Be aware the smoke alarm is not fool proof and cannot detect fires if smoke does not reach it. Anything preventing smoke from reaching the alarm may delay or prevent an alarm.

Though the alarm horn in this detector meets or exceeds current UL standards, it may not be heard for reasons that include (but not limited to): a closed or partially closed door, other noise from electronics, appliances or traffic.

WARNING

This smoke alarm will not alert hearing impaired residents. Special alarms with flashing strobe lights are recommended for the hearing impaired

The smoke alarm is operational once the battery is correctly installed. It will not function if the battery is missing, disconnected, dead, the wrong type or not installed correctly. **It requires one standard 9V battery.** Refer to the user's guide, for correct battery and installation information,

The LED light will indicate the battery is functioning properly. When the production of combustion is sensed, the smoke detector sounds a loud alarm that continues until the air is cleared. The LED light will also give a visual indication of a sounding alarm.

When the battery becomes weak, the alarm will “beep” about once a minute indicating a low battery. This warning should last for 30 days. You **MUST** replace the battery once the alarms low battery warning (beeping) starts to assure continued protection.

WARNING

Only use the replacement battery recommended by the smoke detector manufacturer. The smoke detector alarm may not operate properly with other batteries. Never use a rechargeable battery as it may not provide a constant charge. Never disconnect the battery to silence the alarm.

When the battery is removed from the alarm, the battery flag will pop up; the alarm cannot be installed to the mounting bracket without a battery.

To test, stand at arm's length from the smoke alarm as the alarm horn is loud and may be harmful to your hearing. The test button will accurately test all functions. Never use an open flame to test the smoke alarm.

WARNING

Test the smoke alarm operation after the vehicle has been in storage, before each trip and at least once per week during use. Do not disconnect the battery or the alarm.

Do not remove the warning label located near the smoke alarm from your recreation vehicle:

⚠ WARNING

Test smoke alarm operation after vehicle has been in storage, before each trip, and at least once per week during use. Failure to do so can result in death or serious injury.

⚠ AVERTISSEMENT

VÉRIFIER LE DÉTECTEUR DE FUMÉE SI LE VÉHICULE A ÉTÉ ENTREPOSÉ, AVANT CHAQUE DÉPLACEMENT ET AU MOINS UNE FOIS PAR SEMAINE EN SERVICE.

Maintenance

Smoke detector warning label

Vacuum off any dust on the cover of the smoke alarm using a soft brush attachment. Test the smoke alarm once you have vacuumed. Never use water, cleaners or solvents to clean the smoke alarm as they may damage the alarm. Do not paint the smoke alarm. Refer to the manufacturer's use guide for detailed maintenance information.

COMBINATION CARBON MONOXIDE/ PROPANE ALARM

Your recreation vehicle is equipped with a combination carbon monoxide (CO)/propane alarm that is listed for use in recreation vehicles. The combination carbon monoxide/propane alarm will only work if it is operational and maintained.

⚠ WARNING

The carbon monoxide detector installed is intended for use in ordinary indoor locations of recreation vehicles. It is not designed to comply with Occupational Safety and Health Administration (OSHA) commercial or industrial standards.

Do not disconnect the battery or the alarm.

Individuals with medical problems may consider using warning devices that provide audible and visual signals for carbon monoxide concentrations under 30 PPM.

This alarm will only indicate the presence of carbon monoxide gas at the sensor. Carbon monoxide gas may be present in other areas.

The ultimate responsibility for protection against toxic carbon monoxide fumes rests solely on you. Installing a carbon monoxide/propane alarm is just the first step in protecting your family from toxic carbon monoxide poisoning

The alarm is wired directly to the 12-volt electrical system, with continuous power being supplied by the recreation vehicle battery. There is no 9-volt battery power supply in the carbon monoxide/propane alarm. **If the battery cable is disconnected at the battery terminals, the combination alarm will not work.**

Be sure to read, understand and follow the owner's information from the manufacturer of the combination CO/propane alarm supplied in your Warranty Packet. This includes information regarding the limited life of the alarm.



LP/Carbon monoxide detector (alarm may vary from model shown)

SECTION 2: OCCUPANT SAFETY

WARNING

The following symptoms are related to carbon monoxide poisoning and should be discussed with all members of the household:

Mild exposure: Slight headache, nausea, vomiting, fatigue (often described as “flu-like” symptoms).

Medium exposure: Severe throbbing headaches, drowsiness, confusion, fast heart rate.

Extreme exposure: Unconsciousness, convulsions, cardio-respiratory failure, death.

Carbon monoxide (CO) is an insidious poison. It is a colorless, odorless and tasteless gas. Many cases of reported carbon monoxide poisoning indicate while victims are aware they are not feeling well, they become so disoriented they are unable to save themselves by either exiting the vehicle or calling for assistance. Young children and household pets may be the first affected.

Your combination carbon monoxide/propane alarm is designed to detect the toxic carbon monoxide fumes that result from incomplete combustion, such as those emitted from appliances, furnaces, fireplaces and auto exhaust. A carbon monoxide/propane alarm is **NOT A SUBSTITUTE** for other combustible gas, fire or smoke alarms. This carbon monoxide alarm is designed to detect carbon monoxide gas from ANY source of combustion. It is not designed to detect smoke, fire or any other gas. Please note that there are hazards against which carbon monoxide detection may not be effective, such as natural gas leaks or explosions.

This alarm is designed to sense the presence of carbon monoxide/propane gas, however there are other combustible fumes or vapors that may be detected by the sensor including (but not limited to): acetone, alcohol, butane and gasoline.

These chemicals can be found in commonly used items such as deodorants, colognes, perfumes, adhesives, lacquer, kerosene, glues, wine, liquor, most cleaning agents and the propellants of aerosol cans.

High temperatures can activate glue and adhesive vapors. If you close up the recreation vehicle on a hot day, the chemicals used in its construction may be detected for months after the vehicle was constructed (for more information, refer to Section 2, Formaldehyde).

What you should do if the alarm sounds

WARNING

Actuation of this detector indicates the presence of carbon monoxide which can kill you.

1. Operate the RESET/SILENCE button.
2. Call your emergency services (fire department or 911).
3. Immediately move to fresh air (outdoors or by an open door or window)
4. Do not re-enter the premises or move away from the open door or window until the

emergency service responders have arrived, the premises have been aired out, and your alarm remains in its normal condition.

If your alarm reactivates within a 24-hour period, repeat steps 1-4 and call a qualified appliance technician to investigate for sources of carbon monoxide from fuel burning equipment and appliances, and inspect for proper operation of this equipment. Make sure that motor vehicle(s) are not, and have not been, operating in an attached garage or adjacent to the recreation vehicle.

If problems are identified during this inspection, have the alarm serviced immediately. Note any combustion equipment not inspected by the technician and consult the manufacturer's instructions or contact the manufacturer directly for more information about carbon monoxide safety and this alarm.

WARNING

Never turn the 12-volt battery disconnect control to the off position and disconnect the battery cable to silence an alarm. The alarm will automatically sense when the level of carbon monoxide in the air reaches below dangerous levels. You should stay outside the vehicle in fresh air until the alarm is silenced. When the alarm sounds, do not stand too close to the alarm. The sound produced by the alarm is loud because it is designed to wake a person in an emergency. Prolonged exposure to the alarm at a close distance may be harmful to your hearing.:

Alarm Signals

- Normal Operation:** The LED will maintain a steady green light, indicating that the alarm is powered.
- CO alarm condition:** The red LED light will remain steady and the alarm will sound 4 “BEEPS” then silent for 5 seconds. These signals indicate immediate action is required.
- Propane gas alarm:** The red LED light will flash and the alarm will sound a steady tone. These signals indicate immediate action is required.
- Alarm malfunction/low battery:** The gas LED will remain off and the Operational/CO LED will alternate re/green and the alarm will sound once every 15 seconds.
- End of life alarm:** The LED will flash red/red, green/green and the alarm will “BEEP” every 25-30 seconds. The alarm should be immediately replaced.

Maintenance

Vacuum the alarm cover at least once a year. Clean the cover by hand using a cloth dampened in clean water. Dry with a soft cloth. Do not spray the front panel of the alarm with cleaning agents or waxes. This action may damage the sensor causing an alarm or cause the alarm to malfunction. Do not paint the face of the alarm.

Testing the combination carbon monoxide/ propane alarm

WARNING

Test the alarm operation after the RV has been in storage, before each trip and at least once per week during use.

SECTION 2: OCCUPANT SAFETY

The TEST/RESET button tests all ELECTRICAL functions of the alarm. The TEST/Mute switch is located on the front of the alarm. Press and hold the test button for 1 second. The alarm is working properly if the GREEN indicator light changes color to RED and the horn beeps 4 times. The Gas LED should also blink red.



NOTE: Pressing the test button does not check the sensor operation. Refer to the carbon monoxide/propane alarm manufacturers user's manual provided in the Warranty Packet for additional information on testing the sensors.

Repair or replace the combination carbon monoxide/propane alarm when the alarm no longer functions. As with any electronic product, it has a limited life. Alarms that do not work cannot protect you.



NOTE: The carbon monoxide/propane alarm manufacturer strongly recommends replacement of the detector five years after the date of purchase.

Refer to the Warranty Packet for more information from the carbon monoxide/ propane alarm manufacturer.

FORMALDEHYDE

Some components in the recreation vehicle contain formaldehyde-based adhesives that may release formaldehyde fumes into the air for an unknown period of time. Individuals who are allergic to formaldehyde gas fumes may experience irritation to eyes, ears, nose and throat. Indoor air quality may also be affected by leaving your vehicle closed for a period of time.

To aid in dissipation, ventilate the recreation vehicle by opening all windows and circulate the air with a fan.

This label is located inside the vehicle near the entry door. The label should be left permanently affixed to the recreation vehicle:

▲ CAUTION

Product in this vehicle may contain formaldehyde, which may be an irritant to you. You may experience a greater concentration during high humidity and temperatures. Ventilate to remove. Consult your owner's manual for additional information.

0192523

DO NOT REMOVE THIS LABEL

EXTENDED OR FULL TIME USAGE

Your new recreation vehicle has been built for enjoyment in a recreational manner. It is not intended for use as full-time quarters or a permanent residence. Continuous living in your vehicle could cause accelerated wear and damage to the various components.

 CAUTION

Continuous or permanent living in your recreation vehicle may affect your warranty coverage and may void the “Limited Warranty” applicable to your vehicle.

COLD WEATHER USAGE

When used in freezing or below freezing temperatures, the precautions should be taken:

- Fresh water and drainage systems - preparations to avoid freeze-ups.
- Propane gas (if so equipped) and sufficient power is needed for protection from possible freeze-ups on the propane gas regulator. Keep in mind that more frequent furnace operation will substantially increase battery draw and propane gas use.
- During cool weather usage, ventilation or addition of a dehumidifier may be required to reduce condensation.
- Check outside extrusions on compartment doors, locks, slide outs, windows, vents, etc., for frozen moisture before operating to avoid damage to parts.

CONDENSATION

 WARNING

Condensation may cause dampness, mildew, mold, staining and, if allowed to continue, it may result in damage to the recreation vehicle (damage caused by condensation is not warrantable). It can also lead to mold or mildew issues, which could be a health hazard.

Condensation is a natural phenomenon. The amount of condensation will vary with climate conditions, particularly the relative humidity. Condensation occurs because there is water vapor present in the air. When the temperature reaches the “dew point” the water vapor in the air condenses and changes to a liquid form.

Proper ventilation or the use of a dehumidifier (customer supplied) will assist in controlling the condensation. Suggestions to eliminate warm moist air:

- Crack open windows and roof vents to allow warm moist air to escape.
- Open the bath roof vent (if so equipped) approximately ½” when showering.
- Use the range hood fan (if so equipped) when cooking or washing dishes.
- Avoid hanging wet towels (or clothes) inside the recreation vehicle to dry.
- If found in cabinets or closets, open the doors slightly to provide ventilation.

SECTION 2: OCCUPANT SAFETY

Notes:

TOW VEHICLE

If you plan to tow your recreation vehicle with a tow vehicle you already own, or if you plan to purchase a new one, make sure the Gross Vehicle Weight Rating (GVWR) or your recreation vehicle does not exceed your tow vehicles towing rating.

Ask your automotive dealer how to obtain a copy of information that deals with towing considerations, with or without an optional vehicle tow package.

VEHICLE LABELS

Decals and data plates used throughout the recreation vehicle aid in its safe and efficient operation; others give service instructions. Read all decals, data and instruction plates before operating your recreation vehicle. Any decal, data or instruction plate painted over, damaged or removed should be replaced.

Keep a record of the 17-digit chassis vehicle identification number (VIN), the 8-digit serial number, and your license number in the event theft or vandalism requires you to supply this information to the authorities.

WARNING

The factory-installed weight labels are specific to the recreation vehicle for which they are supplied and are not interchangeable. Do not remove these labels from your RV. If labels are missing contact your dealer or Jayco Customer Service for replacements.

Weight Terms

GAWR - Gross Axle Weight Rating: The value specified by the vehicle manufacturer as the load-carrying capacity of a single axle system, as measured at the tire-to-ground interfaces. This is the total weight a given axle is capable of carrying.

GCWR - Gross Combined Weight Rating: The value specified by the trailer manufacturer as the maximum allowable loaded weight of the trailer including full propane cylinders, a full load of water, and full generator fuel if applicable.

GVWR - Gross Vehicle Weight Rating: The value specified by the manufacturer as the maximum permissible weight of the fully loaded trailer.

OCCC - Occupant And Cargo Carrying Capacity: Is equal to the GVWR of the trailer, minus the weight of the trailer (as completed at the factory) minus the weight of all personal cargo, and, if applicable, minus the weight of a full tank (or tanks) of propane and the full weight of potable water, including the water heater (if so equipped). Additions to or other changes made to the trailer after it left the factory will affect (reduce) the OCCC.

UVW - Unloaded Vehicle Weight: The weight of the trailer as manufactured at the factory with the weight of a full tank (or tanks) of propane.

WARNING

Do not exceed any applicable weight ratings. Doing so could damage your RV or tow vehicle and adversely affect handling and braking characteristics.

SECTION 3: PRE-TRAVEL INFORMATION

Weight and Capacity Labels

The following labels are typically located on the roadside front corner of the RV. An additional Occupant & Cargo Carrying Capacity label is also located on the inward surface of the entry door.

OCCE Label (Occupant & Cargo Carrying Capacity):

The upper portion of this label is federally required and includes the maximum Occupant & Cargo Carrying Capacity that may be placed in or on the trailer as it was manufactured and weighed before leaving the factory. This maximum capacity would not include the weight of a full fresh water tank. The full load of water weight would need to be subtracted from the maximum cargo weight.

Additions or other changes made to the trailer after it leaves the factory will affect (reduce) the OCCE. The lower portion of this label is provided voluntarily and indicates the weight value of the trailer as it was manufactured and weighed at the factory. It includes full propane tanks and full generator fuel (if so equipped).

RECREATION VEHICLE TRAILER CARGO CARRYING CAPACITY
 VIN: XXXXXXXXXXXXXXXX
 THE WEIGHT OF CARGO SHOULD NEVER EXCEED:
 545 kg OR (1207 Lbs.)
 CAUTION:
 A FULL LOAD OF WATER EQUALS 166 kg OR (365 Lbs.) OF
 CARGO @ 1 kg/L (8.3 LB/GAL)
 THE WEIGHT OF THIS RECREATION VEHICLE TRAILER AS COMPLETED AT
 THE FACTORY WITH FULL PROPANE CYLINDERS AND FULL GENERATOR
 FUEL IF APPLICABLE IS: 2860 kg OR (6299 Lbs.)
 CONSULT YOUR DEALER AND SEE OWNER'S MANUAL FOR DEFINITIONS,
 ADDITIONAL WEIGHT, LOADING, WEIGHING INFORMATION AND
 TOWING GUIDELINES

OCCE Label (yellow)

NOTE: The total weight capacity of the tires on your RV can be less than the GVWR. The calculation for the actual weight on the RV tires does not include the tongue weight. The tongue weight is actually being carried by your tow vehicle, not the RV tires.

For example: If the tires are rated at 2,000 lbs. each x 4 tires = 8,000 lbs. and the RV has a GVWR of 9,000 lbs. with a tongue weight of 1,200 lbs. The actual weight on the RV tires is (9,000 – 1,200) which equals 7,800 lbs. which is within the weight rating of the tires.

The **Federal Certification Label** is required by the government to verify the trailer complies with all motor vehicle standards for Canada and the United States. It includes the following information: Manufacturer name, VIN, GVWR, GAWR (front/rear), tire & rim sizes and cold tire inflation pressures.

Tire and Loading Label provides information on the tire sizes, cold tire inflation pressures, the VIN and maximum cargo capacity. The maximum cargo capacity listed on the label does not include the weight of a full load of water.

If you have further questions, please contact your dealer or our Customer Service department.

RESP. INF.:	VIN: VINLVLV		08/11
FABRICANT RESP.:	SIZE/DIMENSION	PRESS./COLD INFL.	
0950 4517		PRESS./COLD INFL.	
GAWR/PNEU. KG	TIRE/PNEU	RIMS/JANTE	PSI/KPA
5000, 2270, FRONT/DEVANT	ST225/75R15D, 15 X 8, J.J.		85, 449
00000, INT/CENTRAL	ST225/75R15D, 15 X 8, J.J.		0000,
5000, 2270, REAR/ARRIERE	ST225/75R15D, 15 X 8, J.J.		85, 0449.
TYPE OF VEHICLE/TYPE DE VEHICULE:		TYPE DE VEHICULE/MODELE:	
THE VEHICLE CONFORMS TO ALL APPLICABLE FEDERAL MOTOR VEHICLE SAFETY STANDARDS AND IS MANUFACTURED PURSUANT TO THE CANADIAN MOTOR VEHICLE SAFETY REGULATIONS IN EFFECT ON THE DATE OF MANUFACTURE SHOWN ABOVE.		THE VEHICLE CONFORMS A TOUTES LES NORMES EN LIEU D'APPLICATION EN VIGUEUR POUR LA SECURITE DE VEHICULES AUTOMOBILES ET CONFORME A TOUTES LES NORMES EN VIGUEUR AU CANADA EN MATIERE DE SECURITE DE LA FABRICATION D'UN VEHICULE.	

Federal Certification Label

TIRE AND LOADING INFORMATION RENSEIGNEMENTS SUR LES PNEUS ET LE CHARGEMENT			
The weight of cargo should not exceed		kg	lbs.
Le poids du chargement ne doit jamais dépasser		645	1424
TIRE PNEU	SIZE DIMENSIONS	COLD TIRE PRESSURE PRESSION DES PNEUS A FROID	SEE OWNER'S MANUAL FOR ADDITIONAL INFORMATION
FRONT AVANT	ST225/75R15D	449 KPA, 65 PSI	VOIR LE MANUEL DE L'USAGER POUR PLUS DE RENSEIGNEMENTS
REAR ARRIERE	ST225/75R15D	449 KPA, 65 PSI	
SPARE DE SECOURS	ST225/75R15D	449 KPA, 65 PSI	

Tire & Loading Information

LOADING YOUR RECREATION VEHICLE

⚠ WARNING

Never load the RV in excess of the GAWR for either axle. Overloading your RV may result in adverse handling characteristics and damage to the chassis.

Store and secure all loose items inside the RV before traveling. Overlooked items such as canned goods, or small appliances on the countertop, cooking pans on the range or free-standing furniture items can become dangerous projectiles during a sudden stop.

Distribute cargo side-to-side so the weight on each tire does not exceed one-half of the GAWR for either axle. Store and secure all loose items inside the RV before traveling. Make sure any tie down straps (if so equipped) on appliances or furniture are secure. Load heavy objects on the floor, or as low as possible.

⚠ WARNING

Your recreation vehicle's load capacity is designated by weight, not by volume, so you cannot necessarily use all available space when loading the vehicle. Do not exceed your GVWR and ensure you are loading the vehicle as evenly as you can for the best possible handling. Ensure heavy items are secured so they do not shift during travel.

⚠ WARNING

DO NOT EXCEED YOUR GVWR! This means you should weigh your RV as loaded for your normal travel to determine the actual weight. If you exceed the GVWR, you **MUST** remove items from the RV, or drain liquids, then re-weigh the vehicle to ensure you have achieved a safe weight. Do not travel with full grey/black holding tanks. This not only wastes gas but, depending upon the location of the grey or black holding tanks, can affect handling characteristics.

⚠ WARNING

Store items in areas designated for storage. Do not store anything in the areas reserved for the converter, electrical panels or the furnace or water heater, etc.

SECTION 3: PRE-TRAVEL INFORMATION

CARGO CARRYING ACCESSORY RECEIVER (IF SO EQUIPPED)

WARNING

Receiver is for cargo carrying accessories **ONLY**. **DO NOT** tow any trailer or other vehicle. **Load Limit for this receiver is 300 lbs Maximum**. Use for towing or exceeding load limit will void the warranty. Failure to follow the instructions can cause the carrier to collapse or items to fall which could cause an accident resulting in death or serious injury.

REAR BUMPER

CAUTION

Do not add items to the recreation vehicle rear bumper. Add-on items will eventually damage your bumper. Damage caused by such aftermarket equipment installation or improper loading voids the **Towable Limited Warranty**.

The rear bumper of your recreation vehicle is not designed to carry cargo. Items that extend beyond the bumper OR weigh over 100 lbs. (45kg) will place undo strain on the bumper. The 100 lb. bumper capacity includes the weight of the spare tire (if so equipped).



NOTE: Some items may fall within the given weight range, (like bike racks) however, they can still cause damage. Over time, added bumper weight will cause damage from the motion created while traveling. In addition, extra weight behind the axle may reduce the hitch weigh which can adversely affect handling.

FIFTH WHEEL PIN BOX (CUSTOMER SUPPLIED)

Hitch selection affects the towing and handling characteristics of your recreation vehicle. There are many kinds of hitches available and assuring that you have the correct hitch installed is critical to a safe towing.

Ask your dealer about the proper class and type of hitch you need to purchase for your individual tow vehicle/RV combination. A fifth wheel requires a pin box hitch bolted directly to the floor of the truck box through the frame.

The hitch class rating based on the capacity that hitch has for towing and a weight classification. The weight classification is determined from the hitch's weight carrying capacity (the pin box weight on a fifth wheel). Before selecting a hitch, you must know your GVWR and pin box rating. **The rating of the hitch package purchased should be equal to or greater than the RV's GVWR and the pin box rating.**

 **CAUTION**

Using an oversized or undersized hitch can cause damage to the RV frame. Jayco cannot be responsible for the tow vehicle suspension system. The final ball height after the tow vehicle/fifth wheel combination is completely hooked up is a factor that must be considered. To avoid overloading your trailer axles and minimize possible handling difficulties, your trailer should be level when hooked to your tow vehicle. Do not overload your tow vehicle.

Equipment that sometimes gives autos, trucks and sport utility vehicles a softer ride can accentuate swaying when pulling a RV; conversely, suspension that is too stiff will increase vibration, bounce and accelerate wear of your tow vehicle and RV combination.

Jayco cannot be responsible for the suspension system of any tow vehicle. There are a variety of tow vehicle suspension systems available that will affect the pin box height, stability and levelness of a hooked up RV. Make sure your dealer is aware of the tow vehicle you are using so a compatible hookup is achieved.

Fifth wheel pin box

The fifth wheel factory installed pin box is not interchangeable. Maintain the proper pin box weight on the hitch.

Fifth wheel pin box height

There is no recommended hitch height for fifth wheels; usually the fifth wheel pin box is adjustable for variance in trucks and truck suspension systems.

Adjust the hitch assembly so the tow vehicle and the fifth wheel are essentially level. A high hitch will transfer weight behind the axles and cause the vehicle to fishtail.

A low hitch will transfer additional weight to the hitch. Refer to the hitch manufacturer instructions to adjust the weight distributing hitch to the proper height.

If you have additional questions, consult with your dealer. Make certain your Dealer is aware of the tow vehicle you are using so a compatible hookup is achieved.

FIFTH WHEEL HITCHING PROCEDURE

The following procedure will help to assist you in securely hooking up your recreation vehicle to your tow vehicle.

1. Make sure the trailer wheels are blocked.
2. Make sure the hitch lever is in its open or “cocked” position unless it has been designed to open automatically. Adjust the fifth-wheel travel trailer pin to the proper height. Lower the tailgate, if applicable.
3. Back the truck so the hitch encircles the fifth-wheel travel trailer pin.
4. A gentle contact of the hitch saddle against the pin will cause the mechanism to close.
5. Secure the hitch lever as specified by the manufacturer.
6. Put the truck in drive (DO NOT press on the accelerator) and ‘bump’ the hitch to make sure it is locked.
7. Be sure to raise the fifth-wheel landing gear all the way up.

SECTION 3: PRE-TRAVEL INFORMATION

8. Attach the breakaway switch cable to the tow vehicle.
 9. Plug the wire harness/connector plug from the tow vehicle to the fifth wheel.
 10. Remove the wheel chocks from the trailer wheels.
- Fifth wheel landing gear** can be operated manually. The fifth wheel landing gear must be fully retracted before moving or towing the RV to prevent damage.

⚠ WARNING

DO NOT USE THE FIFTH WHEEL LANDING GEAR TO SUPPORT THE TOW VEHICLE WEIGHT. The fifth wheel landing gear is designed to bear the front loaded weight of the RV only.

WIRE HARNESS/CONNECTOR PLUG

A 7-way wire harness/connector plug is wired into your trailer to connect electrical power from the tow vehicle for travel. This supplies power to the RV brakes, tail lights, clearance lights, turn signals, brake lights, etc. Wiring to operate your brakes must be the same size in both the tow vehicle and RV (the RV brake wiring is 12-gauge wire).

When attaching wires to your tow vehicle, tape all the connections for moisture protection.

White	1	Ground
Blue	2	Brakes
Green	3	Running lights
Black	4	Auxiliary battery charge line
Red	5	Stop & left turn
Brown	6	Stop & right turn
Yellow	7	Back up



7-Way trailer plug-car end-rear view

The connector plug may build up corrosion with extended use and should be cleaned periodically to insure good electrical contact. Make sure the connector plug is kept clean and protected from road elements as you travel.

WEIGHING YOUR TOW VEHICLE & RV

When the RV is fully loaded it should be weighed. The actual weight of the vehicle, all options, liquids, the hitch weight, and your personal cargo is important for you to know so you do not exceed the GVWR. Two important factors when loading your RV are total weight and balance.

It is imperative that you verify compliance within all applicable weight ratings. Overloading your RV will void the **Towable Limited Warranty** and the warranties of many component part manufacturers.

Periodically weigh your RV at a public scale to determine proper load distribution. To obtain the side-to-side weights, there needs to be enough space on either side of the scale to accommodate the RV being partially off the scale.

Keep in mind that individual scales will operate differently.

To weigh your tow vehicle and RV

 WARNING

Total weight of your tow vehicle and RV must not exceed the GCWR. Do not assume that you can tow a RV that happens to be within the capacity of the tow vehicle hitch. By doing so, you may exceed the total GCWR of your tow vehicle and RV towing combination.

Your RV must be weighed fully loaded (with food, clothing, fuel, water, propane, supplies, etc).

1. Weigh the RV including the tongue weight, while detached from the tow vehicle. This actual overall weight must be less than or equal to the GVWR for safe operation. If the overall weight is greater than the GVWR, some contents must be removed until the actual overall weight is less than or equal to GVWR.
2. Hitch the RV to your tow vehicle. Weigh the RV and the tow vehicle to determine the GCW. Make sure that this rating is less than or equal to the GCWR as specified by the manufacturer of your tow vehicle. If this overall weight is greater than the GCWR, some contents must be removed to bring the combination into compliance with the listed ratings.
3. Weigh the RV while attached to but excluding the tow vehicle. This will result in the actual weight that is exerted on all of the RV tires. This weight may be subtracted from the overall RV GVWR to determine the actual “tongue” weight.
4. With the RV still attached to the tow vehicle, weigh each wheel position separately to ensure each tire is not overloaded.

To determine the wheel position weight:

5. Pull the RV onto the scale so only one tire is on the scale. Record the weight. Your RV must remain as level as possible on the scale (even though an axle or side is not physically on the scale).

To calculate the opposite side of the RV wheel position weight, subtract the first side’s weight from the weight determined in step #3.

If there is a difference in the weights on one side of the vehicle as compared to weights on the other side, components (tires, wheels, brakes, springs, etc.) on the heavier side could be overloaded, even though the total axle load is within the GAWR.

Once actual weights are obtained, compare them to the **Weight Information Label** weight ratings to ensure you are below the posted minimum ratings.

 WARNING

It is important to redistribute the load to avoid component failure as well as to improve the handling characteristics of the vehicle and not void the **Towable Limited Warranty**.

See the *Weight Terms and Loading Your RV* sections for important weight information.

SECTION 3: PRE-TRAVEL INFORMATION

Notes:

TOWING

⚠ WARNING

Your RV braking system is rated for operation at GVWR **not** GCWR.

⚠ WARNING

Whenever possible, do not travel with waste in the holding tanks. Liquid or debris in the holding tank(s) may affect the towing characteristics and may result in property damage or personal injury.

⚠ WARNING

The propane cylinder(s) should be turned off when traveling. Most refrigerators will keep food cold or frozen for eight hours without running while you travel

Your RV will travel safely and comfortably at highway speed limits. It will take longer than a passenger automobile to reach that speed. Allow more time to go around vehicles you are passing. Avoid situations that might require sudden momentum changes as the length of the tow vehicle/RV combination affects your ability to quickly cut back into traffic. Swerves and sharp turns, especially at high speeds, could result in loss of control of the tow vehicle/RV.

Even though your RV is equipped with brakes designed for GVWR, proceed with caution until you become accustomed to your RV's stopping distance. Slow down in advance of dips, bumps and railroad tracks to reduce the jolting to your tow vehicle/RV combination. Proceed slowly and let the trailer tires pass over them before accelerating.

Adverse weather conditions and extremes in terrain may affect the performance and handling of your tow vehicle. Do not operate the tow vehicle cruise control on icy or extremely wet roads, winding roads, in heavy traffic or in any other traffic situation where a constant speed cannot be maintained.

When descending a long hill, drop down into a lower gear or range. Avoid conditions that require excessive and prolonged use of your brakes. Apply and release brakes at short intervals to allow them to cool. The tow vehicle transmission and engine will help in controlling downhill speed and can lengthen brake life. Use care when accelerating or decelerating on a slippery surface. Abrupt speed changes can cause skidding and loss of control.

Driving through water deep enough to wet the brakes may affect stopping distance or cause the vehicle to pull to one side. Check the RV's brake operation in a safe area to be sure they have not been affected. Never operate any vehicle if a difference in braking efficiency is noticeable.

Know the weight and size of your towing combination and observe any posted weight and clearance limits. The added height of roof air conditioners, TV antennas or floodlights may cause clearance problems around some tunnels, canopies and hanging signs.

SECTION 4: VEHICLE OPERATION

When turning, the tires do not follow the path of your tow vehicle tires. The RV will make a tighter turn than the tow vehicle. Compensate for this action by carefully pulling the tow vehicle out into the intersection further than you would normally so that the RV clears the curb. When making a turn, check the road clearance and be aware of others. Swerves and sharp turns, especially at high speeds, could result in loss of control of the RV.

If your camping destination does not have pull through sites, pick a level site and back in carefully. Check to ensure there are no obstacles in your path and that you have plenty of vehicle clearance.

After the RV is in the desired location, set the tow vehicle parking brake. Block all RV wheels securely with wheel chocks to prevent it from rolling.

TOWING BEHIND YOUR RV

WARNING

If you do not have a **Jayco factory installed hitch receiver**, towing items behind your Jayco RV, or overloading the rear, will void the warranty and may result in: damage to the RV or add-on items, towing difficulties, property damage and/or personal injury.



NOTE: IF YOU DO NOT HAVE A JAYCO FACTORY INSTALLED HITCH RECEIVER, DO NOT TOW ANYTHING BEHIND YOUR RV. THE RV FRAME AND BUMPER ARE NOT DESIGNED FOR TOWING.

RV BRAKE SYSTEM

WARNING

Failure to maintain the brakes in proper working condition as specified in the operator's manual supplied by the axle OEM will cause property damage, personal injury and possibly death. Consult with your dealer for assistance.

Electric brakes

The electric brakes are designed to work with the tow vehicle brakes. To maintain proper braking performance, both the RV and tow vehicle brakes must be used together. Separate use of the braking systems will cause accelerated wear and damage.

When your RV is new, it is impossible to adjust the brake shoes precisely. It takes approximately 1,000 miles and/or 50 medium to heavy stops to "burnish" fit or "seat" the shoes to the brake drum. After the initial break-in period your brake shoes must be adjusted accurately for best performance and increased durability.

Braking system components include:

- Tow vehicle battery
- Brake controller
- Wire harness/connector plug
- Trailer battery
- Breakaway switch

The tow vehicle battery is the primary source of power for your RV's electric brake operation. To ensure available power when needed, keep your tow vehicle battery and charging system working properly.

Brake controller (customer supplied)

The brake controller should be installed in the tow vehicle to work in conjunction with the RV electric brakes. Consult with your dealer or the brake controller OEM to decide what is right for your towing combination.

Travel Trailer Breakaway Switch

CAUTION

NEVER use the breakaway switch and trailer brake system as a parking brake. Doing so would create a high amp draw on the battery and converter. This can cause damage to wiring, connectors and the breakaway switch.

The breakaway switch is a crucial part of the RV braking system. Located on the travel trailer A-frame, this switch will apply the trailer brakes if the trailer becomes detached from the tow vehicle. Attach the breakaway switch lanyard to a permanent part of the tow vehicle (on a travel trailer do not attach it to the hitch ball or similar removable parts) when hitching the trailer. If the RV becomes detached from the tow vehicle, the pull pin will be pulled from the switch. This automatically causes the switch to "close" and activates the RV brakes. **A battery (customer supplied) must be installed to activate the breakaway switch.**

Hydraulic brakes (if so equipped)

Your RV may be equipped with hydraulic surge brakes that operate automatically as the tow vehicle's brakes are applied. When speed is decreased and brakes are applied, the weight of the trailer moving forward creates a reaction which causes the brake fluid inside the wheel cylinder to activate the brake shoes against the drum.

As a result of this design, backing the RV uphill may activate the surge brake system making it difficult to continue in reverse. To aid in backing up the RV;

1. Prior to backing up a slope or through soft ground, pull the recreation vehicle forward slightly to assure that the actuator socket is in the forward position.
2. Move the lever on the side of the actuator downward from the "towing position" along the curved slot in the actuator frame to the "backup position." The slot has a notch at the bottom of its travel. Push the lever down to engage the locking notch.
3. The RV will now back up. This lever will slide into the correct position when pulling forward.

It is extremely important to keep the master cylinder full at all times. An empty cylinder invites moisture.

SECTION 4: VEHICLE OPERATION

Disc Brakes (if so equipped)

If your RV is equipped with disc brakes, see the manufacturer's owner's manual for detailed safety and maintenance information.

ENTRANCE DOOR STEP(S)

Make sure your entrance step is fully extended before exiting the vehicle, and retracted prior to towing.

Lubricating the step mechanism

Carefully clean the area around the pivot points (the rivets involved in the motion of the mechanism). Lubricate these pivot points with an automotive grade, non-staining lubricant every 30 to 60 days.

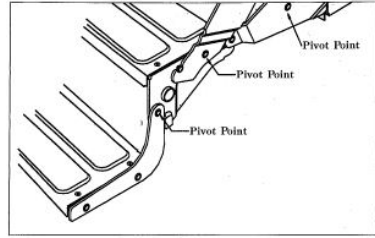

RV Step

Wipe any excess lubricant off of the step and then clean the entire step after lubricating.

ENTRANCE DOOR



CAUTION

Make sure the entrance door is completely closed and locked when traveling. Locking the door helps prevent it from opening unintentionally.

Always hold onto the entrance door when opening or closing it as damage caused because you failed to do so is not covered by the **Towable Limited Warranty**.

KEYS

Several keys are provided when you purchase your vehicle. Most keys have an individual key number stamped on the plate. Record these key numbers and keep the information in a safe place. You can order a key blank from your dealer to have duplicate keys made. If you lose the keys, contact your dealer or a locksmith for assistance. **Make sure the keys are not inside the vehicle before you close and lock the entrance door.**



NOTE: Locks on entrance and baggage doors need biannual lubrication using a light coat of silicone spray. Conditions such as rain, salt, dust and pollution may increase the maintenance needs.

KEYLESS ENTRY (IF SO EQUIPPED)

If your RV is equipped with a keyless entry system, it is a battery operated system. Programming and changing batteries on the lock system are described in the following sections.

For detailed instructions, please refer to the manufacturer's operators manual included in your warranty packet.

Battery powered keyless entry system:

The battery powered entry system is a 4 button touch pad programmable deadbolt lock. The 4 buttons are labeled “1|2”, “3|4”, “5|6”, “7|8”. The button labeled “1|2” is the same button whether the number 1 or 2 is desired. Please note this handle uses touch technology. The buttons are activated by touch and do not require pressing the buttons. Touch the button and lift finger from button for proper code entry.

Operation

The entry system incorporates proximity sensing to determine when you want to activate the lock. To operate the lock you first must “wake up” the lock, by touching the “wake up area” to the right of the buttons. The buttons will illuminate once the Touch Pad is awakened. This indicates that the touch pad is ready for the code to be entered. (Refer to the diagram on next page)

Preset Factory Code

The entry system has a factory set code of 3,7,1,5 followed by the Enter button. The Enter button is the bottom button with the picture of the key. The Enter button is required to be touched after the code is entered. The factory code resets every time the batteries are removed for at least 10 seconds.

Programming New Code

To set a new code, wake up the lock by touching the “wake up area”. Then touch and hold both the “3|4” button and the Enter Button for 2 seconds. The system will provide three short beeps, indicating it is ready to accept a new code. Enter the new 4 digit code followed by the Enter button. The system will provide four short beeps to indicate new code acceptance. This new code will now activate the lock.

To reset the code, remove the batteries for at least 10 seconds. Re-install the batteries; and follow the steps to **Programming New Code**.

Please Enter Personal Code to prevent inadvertent programming.

System Fault Logic:

Action	Response
Ready to Accept New Code	Three short beeps
New Code Entered	Four short beeps
Wrong Code Entered	One long beep
Dead Bolt Locks	Two short beeps
Dead Bolt Unlocks	Two short beeps
Dead Bolt fails to Lock	One long beep
Dead Bolt fails to Unlock	One long beep
Low Battery	One Long beep after the Lock/Unlock beeps

The lock will cycle up to 10 more times once the low battery indication occurs. After this the final electric function in a low battery condition will be unlock and will not lock until the batteries have been replaced. Please note that if the deadbolt is in the locked position and the batteries die the deadbolt will remain locked. The key will always be able to activate the deadbolt lock.

SECTION 4: VEHICLE OPERATION

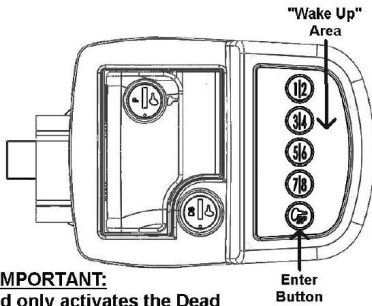

IMPORTANT:

The Touch Pad only activates the Dead Bolt. The Paddle Lock is Master Keyed for Dealer and Service Center use. The Dead Bolt provides Maximum Security

1. Touch the area next to the Buttons to "Wake Up" the lock.
2. The Buttons will illuminate when the lock is "awake" and ready to accept the code.
3. The factory default code is activated by touching the 3,7,1,5 Buttons followed by the Enter Button.
4. To program your Personal Code touch and hold the "34" Button and Enter Button for 2 seconds. The lock will beep 3 times indicating it is ready to accept a new code. Enter a 4 digit code followed by the Enter Button. The lock will beep 4 times to indicate a new code has been entered. The first time the new 4 digit code is entered there will be a long beep indicating the new code is accepted. The new code can be entered now and will activate the dead bolt.

Please enter your Personal Code to prevent inadvertent programming

General Maintenance and Operating Guidelines

- Install fresh batteries as necessary. The lock is designed to function for months of normal usage with fresh, high quality AA batteries. Battery life is highly dependent upon battery quality, usage, and environment (temperature).
- Make sure there are no obstructions in the door frame to prevent Dead Bolt extension.
- Do not wash with power washer or high pressure cleaner. The lock is designed to resist water intrusion to protect its electrical components from normal water encounter such as rain.
- The lock uses Touch Technology. The buttons are activated by **touching not pressing.**
- Remove batteries when storing or not using this lock for extended periods of time. (**Note:** the factory code will reset when the batteries are removed for longer than 10 seconds)

Rain Sensing Technology:

The lock system has Rain Sensing Technology to preserve battery life. Rain will wake up the touch pad and illuminate the buttons. After a few seconds of contact from rain (water) the lights turn off, but a code can be entered and the lock will function normally. The same effect occurs if the operator touches a button for a prolonged period of time. The buttons will illuminate, but then turn off. Again the lock will function normally.

Additional Security Feature:

The lock system recognizes the first 4 digits entered as the code. However if you feel someone is watching you enter the code you can continue to enter digits after the first 4 prior to touching the enter button. For example, if your code is 8,1,3,9 and you felt like you were being watched you would enter 8,1,3,9 then continue to touch additional digits before touching the enter button and the lock will still operate.

Trouble shooting

After installation the touch pad does not work

- Batteries are dead
- Batteries are not installed properly
- Plug not engaged properly
- Dead Bolt not engaging into Door Frame

- Obstruction in Door Frame
- Code not working
- Remove Batteries for 10 seconds then Program New Code
- Inside Paddle not Opening Latch
- Inside screws are not secured to the Housing.
- Buttons light but the Dead Bolt does not activate
- Replace the batteries

If the problem is not found on this list, please refer to the manufacturer's operators manual.

Battery Installation:

The entry system uses 4 AA batteries for operation. We do not recommend zinc carbon batteries for this application

Fresh batteries should be installed as necessary. Battery Life is highly dependent upon battery quality, usage, and environment (temperature). Remove batteries if the lock will not be used for extended periods of time.

The following steps are shown on the enclosed Battery Installation schematic.

1. Remove (2) 4x40 screws from Battery Compartment Lid. These screws are very small so please take care in removal and installation.
2. Install the AA batteries in accordance with the orientation symbols shown in the Battery Compartment. The batteries will fit tightly.
3. Install Battery Compartment Lid by aligning the (3) tabs on the lid with the (3) slots on the Inside Plate Assembly. These tabs act as a hinge for closing the Battery Compartment Lid.
4. Install the (2) 4x40 screws back to attach the Battery Compartment Lid to the Inside Plate Assembly.

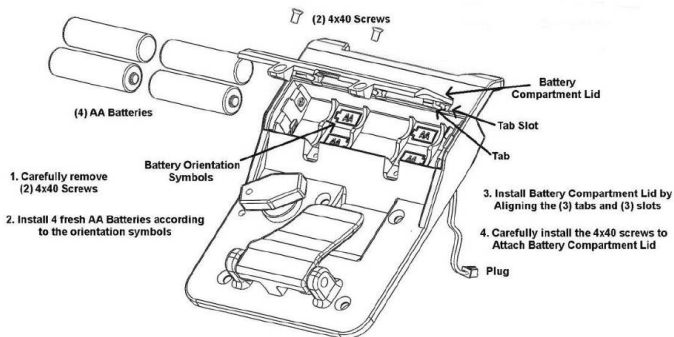

CAMPSITE HOOK-UP

- Refer to *Electrical System* section before connecting the shore line power cord (when using full hook-up) OR before starting the generator (if so equipped) or operating the vehicle on 12-volt power when dry camping.
- Refer to *Fuel & LP System* section before using the LP system. Open the LP gas tank valve (if so equipped) slowly. There may be air in the lines and five to thirty seconds of time is needed to bleed air before LP vapor fills the lines.
- Refer to *Plumbing Systems* section before connecting the fresh water supply or turning ON the water pump or water heater.
- When using full hook-up, connect the sewer hose to the campsite sewer hook-up. If applicable, start the refrigerator and the cooling or heating system.



NOTE: For extended dry camping, management of all your resources is essential. Check your battery levels and conserve battery power, use it sparingly.

LEVELING THE RV

Now that you have parked your recreation vehicle, you need to ensure it is level. Leveling is very important. A level vehicle is more comfortable for sleeping and walking.

The refrigerator is designed to operate when level for best performance due to the absorption system. The water drainage systems are designed with proper slope and must be level for proper operation. The appliances perform best when level.

LIPPERT AUTO LEVELING SYSTEM (IF SO EQUIPPED)

Your recreation vehicle may be equipped with a 4 or 6 point automatic leveling system. The use of the electronic automatic leveling system to support the coach for any reason other than which it is intended is prohibited by Jayco and will violate terms of the limited warranty.

The following is an overview of the system to be used as a quick reference. **For detailed operating and safety instructions refer to the manufacturer's owner's manual and DVD.** Depending on your model, the system may vary slightly from the instructions listed below. Familiarize yourself with the operating and safety instructions prior to using the leveling system.

⚠ WARNING

FAILURE TO ACT IN ACCORDANCE WITH THE FOLLOWING WARNINGS MAY RESULT IN SERIOUS PERSONAL INJURY OR DEATH!

- **NEVER LIFT THE RECREATION VEHICLE COMPLETELY OFF THE GROUND.** LIFTING THE RV SO THE WHEELS ARE NOT TOUCHING THE GROUND WILL CREATE AN UNSTABLE AND UNSAFE CONDITION AND MAY RESULT IN SERIOUS PERSONAL INJURY OR DEATH.
- **THE LEVELING SYSTEM IS DESIGNED ONLY FOR LEVELING THE UNIT AND SHOULD NEVER BE USED TO PROVIDE SERVICE FOR ANY REASON UNDER THE RV SUCH AS CHANGING TIRES OR SERVICING THE SYSTEM.** It is **NOT** recommended that you change a tire yourself.
- **CLEAR ALL JACK LANDING LOCATIONS OF DEBRIS AND OBSTRUCTIONS.** LOCATIONS SHOULD ALSO BE FREE OF DEPRESSIONS.
- **WHEN PARKING THE COACH ON EXTREMELY SOFT SURFACES, UTILIZE THE LOAD DISTRIBUTION PADS UNDER EACH JACK.**
- **PEOPLE AND PETS SHOULD BE CLEAR OF THE COACH WHILE OPERATING THE LEVELING SYSTEM.**
- **KEEP HANDS AND OTHER BODY PARTS CLEAR OF FLUID LEAKS. OIL LEAKS MAY BE UNDER HIGH PRESSURE AND CAN CAUSE SERIOUS SKIN PENETRATING INJURIES.**

The control unit is typically located in the forward basement compartment on the off door (road) side.

Prior to operation, make sure the following conditions are met:

1. The recreation vehicle is parked on a reasonably level surface.
2. Front end of recreation vehicle needs to be supported. It should be attached to a tow vehicle, or supported with jack stands before leveling.
3. Be sure all persons, pets, and property are clear of the trailer while the system is in operation.

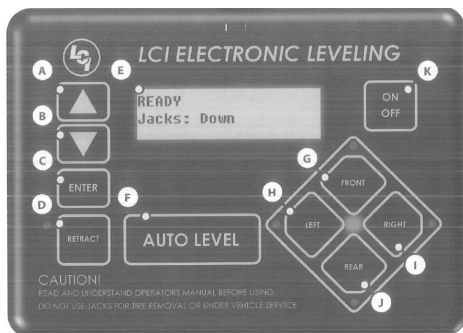

SECTION 4: VEHICLE OPERATION

Leveling control panel callouts

A	Up arrow - scrolls up through the menu on LCD
B	Down arrow – scrolls down through the menu on LCD
C	Enter – Activates modes and procedures indicated on LCD
D	Retract – places leveling system into retract mode. Press and hold down for (1) second to initiate auto retract
E	LCD display – displays procedures and results
F	Auto level – places leveling system into auto level mode.
G	Front jack button – activates front jacks in manual mode
H	Left jack button – Activates left jacks in manual mode
I	Right jack button – activates right jacks in manual mode
J	Rear jack button – activates rear jacks in manual mode
K	Power button – turns leveling system on and off

Basic Jack Operation

Landing gear jacks can be operated any time the system is “ON”. By pushing the “FRONT” button, both front or landing gear jacks can be extended. By pushing either the “FRONT” and “LEFT” or “FRONT” and “RIGHT” buttons, the individual front jacks can be extended. If the touch pad is put in the retract mode, indicated by the orange illuminated LED next to the “RETRACT” button, the front jacks can be retracted together by pushing the “FRONT” button or individually by pressing “LEFT” or “RIGHT” buttons, while simultaneously pressing the “FRONT” button.



NOTE: Middle jacks can only be operated in error mode. In order to engage middle jacks, press “LEFT” and “RIGHT” buttons simultaneously.

The rear jacks can only be extended when the touch pad is in the manual mode. Once system is in manual mode, pressing the “REAR” button will extend both rear jacks at the same time. To extend individual rear jacks, press the “LEFT” or “RIGHT” button while simultaneously pressing the “REAR” button, depending on which jack needs to be operated. If the touch pad is put in the retract mode, indicated by the orange illuminated LED next to the “RETRACT” button, the rear jacks can be retracted together by pushing the “REAR” button or individually by pressing wither the “LEFT” or “RIGHT” buttons while simultaneously pressing the “REAR” button.



NOTE: If the rear jacks will not operate individually using the method described above, but the operate properly when Auto Level is performed, the Twist Prevention Protection system has locked out the operation to prevent damage to the frame of the unit.

STABILIZER JACKS

1. Each stabilizer jack can be individually adjusted to stabilize the trailer for use.
2. When setting your RV up on soft ground, you may wish to place a wood pad or the equivalent under each stabilizer jack foot. This will help keep the stabilizer jack from sinking into the ground.

Manual stabilizer jacks (if so equipped)

1. To lower each jack, insert the jack crank onto the applicable stabilizer jack shaft.
2. Turn the crank clockwise to lower each leg until it contacts the ground and stabilizes the trailer.

To raise each jack, insert the jack crank onto the applicable stabilizer jack shaft and turn the crank counter-clockwise.

Electric stabilizer jacks (if so equipped)

Control switches for the stabilizer jacks are located on the (door) side of the unit above the stabilizer jack(s).

To lower each jack, press the control switch until each leg contacts the ground and stabilizes the unit.

To raise the jack, press the control switch until the jack is returned to the retracted position.



NOTE: The stabilizer jacks must be fully retracted before moving or towing the RV to prevent stabilizer jack damage.

⚠ WARNING

DO NOT USE THE STABILIZER JACKS TO LEVEL THE RV. It is important to remember that the stabilizer jacks are to be used only for support while occupying and moving around the RV. They are not designed to support the weight of the RV.

EMERGENCY STOPPING

Always carry road flares or reflective warning signs to display if necessary. Pull off the roadway as far as possible for emergency stopping or tire changing. Turn ON your vehicle hazard warning flashers. If traveling at night, use three red warning indicators such as flares, reflectors or lanterns as required by the Uniform Vehicle Code and Model Traffic Ordinance as follows:

1. Place the first warning indicator on the traffic side of the recreation vehicle, directed at the nearest approaching traffic.
2. Place the second warning indicator 100 feet behind the recreation vehicle in the center of the lane and toward approaching traffic.

Place the third warning indicator 100 feet in front of the recreation vehicle in the center of the lane and away from the traffic approaching from behind.

SECTION 4: VEHICLE OPERATION



NOTE: Curves and/or hills may affect the safe placement of warning indicators.

WARNING

For personal safety, always stand off the road and out of the way of traffic.

EMERGENCY TOWING

WARNING

Never allow anyone to go under the RV while it is being lifted and/or being towed.

If your recreational vehicle needs to be towed, please contact an emergency road service provider or a qualified service facility for assistance.

WHEEL LUGS

After your first trip, check the wheel lug torque periodically for safety. Check the wheel lugs after winter storage, after a wheel removal, before starting a trip or following extensive braking. Use the correct star pattern sequence to attach the recreation vehicle wheels (see **Wheel Lug Torque Chart**.)

1. Start all nuts by hand to prevent cross threading.
2. Tighten the nuts in the sequence shown.
3. Tighten the lug nuts equally in stages as indicated for your recreational vehicle wheels (see **Wheel Lug Torque Chart**).

Check and re-torque after the first 10, 25 and 50 miles (16, 40 and 80 kilometers). Thereafter, check and maintain the torque according to the listed torque values (see **Wheel Lug Torque Chart.)**



NOTE: The proper method of tightening wheel lug nuts is with a properly calibrated torque wrench and socket, not with an impact wrench or by hand. **Do not use a 4-way lug wrench or any other type of wrench that does not measure the actual pressure applied to the lug nut.**

Because of the importance of having proper torque on the wheel lug nuts, you should always have the wheels mounted and properly torqued by a qualified technician using the proper tools.

WHEEL LUG NUT DIAGRAMS:

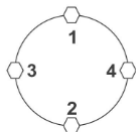

4-Lug Nuts

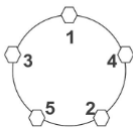

5-Lug Nuts

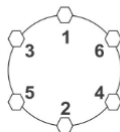

6-Lug Nuts

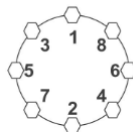

8-Lug Nuts

WHEEL TORQUE INSTRUCTIONS:

1. Start lug nuts with fingers on studs to avoid cross threading.
2. Stage 1, Torque: Impact lug nuts in a star pattern* until snug to rim. -- See *Wheel Lug Nut Diagram*
3. Stage 2, Torque: Use calibrated torque wrench to torque each lug nut, in a star pattern, to the values indicated. Wheels must remain stationary during torquing process for control purposes. --See *Wheel Lug Nut Torque Chart* and *Wheel Lug Nut Diagram*
4. Stage 3, Torque: Use calibrated torque wrench to torque each lug nut, in a star pattern, to the values indicated. Wheels must remain stationary during torquing process for control purposes. --See *Wheel Lug Nut Torque Chart* and *Wheel Lug Nut Diagram*

WHEEL LUG NUT TORQUE CHART:

Lug Nut	Stud Dia.	Rim	Type	Stage 1 Impact Gun	Stage 2 Clicker Setting (+/-3ft/lbs)	Stage 3 Clicker Setting (+/-3ft/lbs)	Acceptable Torque Range
4-Lug Nuts	1/2"	12"	Steel	40-50 ft/lbs	60 ft/lbs	70 ft/lbs	50-75 ft/lbs
5-Lug Nuts	1/2"	13"	Chrm/Steel	40-50 ft/lbs	60 ft/lbs	70 ft/lbs	50-75 ft/lbs
5-Lug Nuts	1/2"	14"	Chrm/Steel/Alum	40-50 ft/lbs	95 ft/lbs	115 ft/lbs	90-120 ft/lbs
5-Lug Nuts	1/2"	15"	Chrm/Steel/Alum	40-50 ft/lbs	95 ft/lbs	115 ft/lbs	90-120 ft/lbs
6-Lug Nuts	1/2"	15"	Chrm/Steel/Alum	40-50 ft/lbs	95 ft/lbs	115 ft/lbs	90-120 ft/lbs
6-Lug Nuts	1/2"	16"	Chrm/Steel	40-50 ft/lbs	95 ft/lbs	115 ft/lbs	90-120 ft/lbs
8-Lug Nuts	1/2"	16"	Steel/Aluminum	40-50 ft/lbs	95 ft/lbs	115 ft/lbs	90-120 ft/lbs
8-Lug Nuts	5/8"	17.5"	Aluminum	50-60 ft/lbs	125 ft/lbs	150 ft/lbs	140-160 ft/lbs

TRANSPORTATION INSTRUCTIONS:

1. Prior to travel and after excessive braking, all wheel lug nuts must be checked for torque.
*This also applies to any service involving wheel or lug removal, during the life of the recreational vehicle.
2. Torque readings must fall within the Acceptable Torque Range. --See *Wheel Lug Nut Torque Chart*
3. Torque specifications, must be checked by using a torque wrench.
*Digital or Dial Torque Wrenches are recommended.
4. If Torque falls below the Acceptable Torque Range, additional torque is required.
-- See *Wheel Torque Instructions* and *Wheel Lug Nut Diagram* for the correct pattern and recommended final torque value.
5. During travel, wheel lug nuts must be checked and re-torqued, as required, after the first, 10 miles, 25 miles, 50 miles, then periodically during travel (16 kilometers, 40 kilometers, 80 kilometers, then periodically during travel).
-- See *Wheel Torque Instructions* and *Wheel Lug Nut Diagram* for the correct pattern and recommended final torque value.
6. Failure to follow these instructions may result in wheel loss, an accident, or loss of control, resulting in death or serious injury.

⚠ WARNING

Check and tighten wheel lug nuts regularly to make sure they did not loosen during travel. Wheel lug nuts must be applied and maintained at the proper torque levels to prevent loose wheels, broken studs and possible separation of the wheel(s) from your recreation vehicle. The lug nuts on the wheels of your recreation vehicle must be maintained according to listed torque values (see **Wheel Lug Torque Chart.**) Over-torqued and/or under-torqued wheels may result in component failure.

TIRES

Read and understand the following before taking your first trip in your recreation vehicle!

Proper care and maintenance of your tires is essential to ensure your safety, as well as the safety of others, as you travel.

Routine maintenance on your recreation vehicle is important, but it cannot be overstated just how critical proper tire maintenance is to the safety, operation and durability of your new vehicle.

SECTION 4: VEHICLE OPERATION

You must follow the manufacturer's inflation guidelines for maximum load capacity; under-inflation is just as dangerous as over-inflation.

To insure your tires are operating safely, regular inspection of your tires and checking tire pressures is absolutely mandatory.

Examine your tires frequently for unusual wear. Alignment, balance and bearing wear will affect tire wear. Make sure to look for cracking, bulging, uneven tread wear, etc.

When you are using your vehicle, check inflation pressure weekly to insure maximum tire life and travel wear. Pressure should be checked when the tires are cold. During travel, tires heat up and pressure increases. **Do not bleed air from hot tires or your tires may then be under-inflated.**



NOTE: Cold tire inflation pressure is defined as a tire that has not been used for three or more hours, or has been driven less than one mile. Tire inflation pressure of a hot tire may show an increase of as much as 6 psi over a cold tire.

Tire pressure is the most important factor in the life and performance of your tires. Proper inflation should be monitored closely. Failure to do so could result in the overheating of a tire, which could result in a blowout. Inflation pressure should be as recommended by the tire manufacturer or as the federal label for the recreation vehicle indicates.

WARNING

It is recommended that the tire pressure be checked at the beginning of each trip to obtain the maximum life of the tire. Follow the instructions listed on the Federal Certification label, affixed to the roadside front corner of your trailer, to determine the correct tire pressure. Under-inflation may cause tire failures and swaying; this may result in loss of control, injury, death or property damage.

DANGER

Failure to follow proper inflation guidelines may result in tire failure, which, under certain circumstances can cause loss of vehicle control or accidents that may result in property damage, bodily injury and/or death.







WARNING

This recreational vehicle is equipped with special trailer (ST) tires that have a maximum speed rating of 65 MPH (104 km/h). **You should not exceed this speed rating.** Exceeding the tire speed rating may result in tire failure, which could lead to a crash causing serious injury or death.

⚠ CAUTION

Tire wear should be checked frequently. Once a wear pattern becomes firmly established in a tire it is difficult to stop, even if the underlying cause is corrected.

Tire Wear Diagnostic Chart

Wear Pattern	Cause	Action
 Center Wear	Over Inflation	Adjust pressure to particular load per tire catalog.
 Edge Wear	Under Inflation	Adjust pressure to particular load per tire catalog.
 Side Wear	Loss of camber or overloading	Make sure load doesn't exceed axle rating. Align at alignment shop.
 Toe Wear	Incorrect toe-in	Align at alignment shop.
 Cupping	Out-of balance	Check bearing adjustment and balance tires.
 Flat Spots	Wheel lockup & tire skidding	Avoid sudden stops when possible and adjust brakes.

CHANGING A TIRE

⚠ WARNING

Do not use the stabilizer jacks to support the RV while under the vehicle or changing tires. The stabilizer jacks are designed as a stabilizing system only. Do not use the stabilizer jacks as a jack or in conjunction with a jack. Attempts to change tires while supporting the RV with the stabilizer jacks could result in damage to the RV and risk causing serious injury or death.

⚠ WARNING

Never raise the RV by placing the jack under the axle, springs or any attachment parts. Failure to comply could result in property damage, personal injury or death.

SECTION 4: VEHICLE OPERATION

1. Keep the recreational vehicle attached to the tow vehicle. Block the tire on the opposite side of the recreational vehicle from the tire you are changing.
2. Loosen the wheel lug on the tire you are changing before jacking up the vehicle. DO NOT remove the lug nuts; only loosen them for ease of removal when the tire is off the ground.
3. Locate the main frame rail of the trailer (it spans from front-to-back just inside the tires).
4. To raise the recreation vehicle, place the jack (hydraulic or screw) under the main frame rail. It must be just ahead of the front tire or just behind the rear tire.

WARNING

Be sure to use only tires that are rated for RV use. The use of passenger tires should be avoided. The load rating/range embossed on the sidewall of passenger tires must be de-rated accordingly; they do not have the same load capability as tires that are specifically identified for RV use. Failure to use tires that are properly matched to your recreation vehicle could lead to premature tire wear or less than optimum trailer handling.

Replacement

If you experience a flat tire on your recreation vehicle while driving, gradually decrease your vehicle speed (if possible). Hold the steering wheel firmly and move the recreation vehicle to a safe place on the side of the road.

Any service or warranty coverage on tires is to be handled by the tire store representing the brand installed on your RV. They are not to be returned to your dealer or Jayco.

WARNING

When replacing a tire make sure to replace it with a tire of the same size and specifications (refer to the Federal Certification label.)

If you have questions regarding your tires, contact the tire manufacturer or Jayco Customer Service.

SPARE TIRE CARRIER (IF SO EQUIPPED)

If your recreation vehicle is equipped with a spare tire, it will either be mounted under the unit (hoist) or on the rear bumper.

Hoist mount

WARNING

DO NOT exceed the maximum load capacities of 100 lbs. for the hoist. DO NOT use air driven guns or impact wrenches to lift the spare tire to the travel position.

Depending on your model, the spare tire may have (side or bottom) brackets or it will be

mounted against the underside of the recreation vehicle (flush mount) to give it stability in travel.

NOTE: If your spare tire is a flush mount application, it must make contact with the underside of the recreation vehicle to insure maximum road clearance and stability in travel.

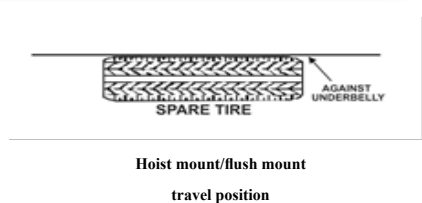
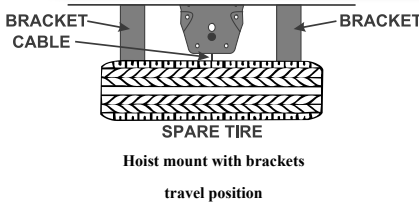

Raising and lowering the hoist

In most cases the crank handle to raise and lower the tire will be located in a basement compartment of the recreation vehicle. Typically, it is fastened to the sidewall of the compartment. Insert the crank handle into the crank access port located either in the center of the rear bumper, or in the sidewall of the RV. Turn the crank handle to lower the tire, or to lift into the travel position. Two “crisp breaks” must be heard and felt to insure the proper seating of the tire for travel.

SPARE TIRE
MANUAL CRANK

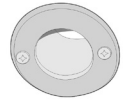

Crank access port

NOTE: If the manual crank access port is located in a slideout, the slideout room must be in the travel position. If the slideout is extended the crank will not reach the mechanism to raise or lower the tire.

Securing the spare tire

To secure the spare tire in the travel position, put the steel hoist lift support located on the end of the cable through the rim of the tire. The hoist lift support clips need to seat inside the center hole of the tire rim. The valve stem of the tire **MUST** be pointed in the up position or toward the bottom of the RV. Reverse this process to release the spare tire for usage.



SECTION 4: VEHICLE OPERATION

Bumper mount

The spare tire bracket can be released and extended down to access a storage compartment at the rear of the trailer without removing the tire.

To extend the tire down

1. Remove the cotter key from the pin holding the tire carrier in place.
2. Remove the pin and extend the tire carrier away from the trailer.
3. Always return the tire carrier to the upright position and lock it in place while traveling.



To remove the tire from the tire carrier

1. Remove the lug nuts holding the tire in place.
2. Remove the support bracket from the bottom lug.
3. Pull the tire from the tire carrier.

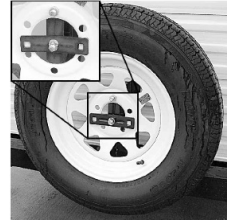

Bumper mount

To install the tire on the tire carrier

1. Place the tire on the carrier with the top lug bolt inserted into one of the holes in the tire rim and the bottom lug bolt in the center of the rim.
2. Install the top lug nut.
3. Place the support bracket over the bottom lug bolt across the center of the rim.
4. Install the bottom lug nut over the support bracket.
5. Make sure the lug nuts are tightened securely before returning to travel.

FIFTH WHEEL SET UP

1. Pull into the site, and park the RV where you want it.
2. Block the wheels securely to prevent the RV from moving.
3. Drop the landing gear (important!) Refer to the operator's manual for proper operation.
4. Disconnect the wire harness/connector plug and breakaway switch lanyard.
5. Drop the truck tailgate (unless you have a tailgate specially designed to accommodate a fifth-wheel hitch).
6. Gently put your truck into reverse (don't give it any fuel/acceleration).
7. This effectively moves the kingpin off the locking bar that will allow you to disengage it.
8. Step on brake and apply parking brake.
9. Disengage the locking bar and unhitch.
10. Drive away.
11. Adjust the fifth-wheel height for proper front to back leveling of the RV.

PATIO AWNING

⚠ WARNING

Awnings must be closed (and locked if applicable) while the RV is in transit.

 CAUTION

It is recommended that if leaving the RV unattended for a length of time, retract the awning to avoid unexpected climate conditions.

 CAUTION

The effects of wind and rain on an awning are unpredictable and can cause severe damage to the awning and/or the RV. If wind or extended periods of rain are expected, retract the awning.

Awning care

Keep your awnings clean and in good condition to prevent costly repairs.

- Periodically check that the fasteners are tight. Tighten if necessary.
- Keep the awning fabric clean. For detailed cleaning information, refer to the manufacturer's owner information included in the Warranty Packet.

The 12-volt power awning (if so equipped) may need to be adjusted (retracted) to operate the entry door (some models).

For detailed safety and operating information, refer to the manufacturer's user guide included in the Warranty Packet.

POWER AWNINGS (If So Equipped)

 WARNING

Awnings must be closed (and locked if applicable) while the RV is in transit.

 CAUTION

- The effects of wind and rain on an awning are unpredictable and can cause severe damage to the awning and/or the recreation vehicle. If wind or extended periods of rain are expected, retract the awning.
- It is recommended that if leaving the recreation vehicle unattended for a length of time, retract the awning to avoid unexpected climate conditions.

Your recreation vehicle may be equipped with multiple (power) awnings which will each have its own control switch. The control switch(s) for each awning is typically located on the command center switch panel located inside the entrance door. Pressing and holding the switch will extend or retract the awning.

Carefree® Awnings (If So Equipped)

Carefree awnings offer the following features:

SECTION 4: VEHICLE OPERATION

- Scissor style arms that do not require vertical ground supports.
- Adjustable arms with (6) position pitch adjustment
- Worm gear driver motor eliminating the need for travel locks.
- Single switch operation, 12V motorized awning.

Refer to the manufacturer's user guide for detailed operating and safety information.

Adjusting the Awning Pitch

The awning arms have 6 pitch adjustment settings from minimum pitch to maximum pitch. The awning can be extended and retracted in any of these positions without having to reset the pitch between uses.

NOTE: Use care when adjusting the pitch as the awning may move abruptly.

1. Hold on to the awning arm to keep it steady while adjusting the pitch.
2. Press in the pitch adjustment pins located on the scissor arm.

NOTE: Applying LIGHT pressure on the arm will decrease the force required to press the pitch adjustment pins.

3. Slide the scissor arm to the desired set hole – towards the coach for a lower pitch and away from the coach for a higher pitch.

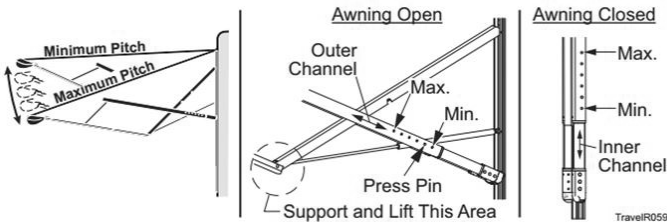

⚠ WARNING

Do not set the individual arm pitch at more than three (3) positions different between the left and right arms. Damage to the arms and the canopy can occur if the awning is retracted when the arms are set at more than three (3) positions difference.

Additional Awning Operation Information

- The awning motor is equipped with a thermal protection circuit to protect the motor from overheating. Operating the awning repeatedly over a short time period may cause the circuit to sense an overheat condition and shut off the motor.
- If this occurs, wait approximately 15 minutes to allow the motor to cool then operate the awning in normal fashion.
- The awning seems to extend and retract slowly. Normal operation time is 28-35 seconds to extend or retract. If the power supply is on the low side of the acceptable voltage range (10VDC – 14VDC) the awning will move slower.
- Always operate the awning according to the instructions.
- Periodically check that the fasteners are tight. (Tighten if necessary)

Keep the awning fabric and arms clean. Carefree® LONGITUDE Awnings (If So Equipped) - Emergency Operation

If power to the vehicle is not available, the awning can be safely retracted by jumping the motor using a 10VDC – 14VDC power source such as a cordless drill battery or car battery

⚠ WARNING

DO NOT USE A 110VAC POWER SOURCE FOR THE EMERGENCY OVERRIDE PROCEDURE! Doing so will permanently damage the awning! Do not use the Emergency Override without following the directions below..

⚠ WARNING

For awnings under 12 feet: The arms must be set at an equal pitch. Damage to the arms and canopy can occur if the awning is retracted with the arms uneven.

1. Remove the front cover. The cover snaps onto the rear cover. To remove, press on both sides of the rear cover until the front cover releases then lift the cover off.
2. Detach the RED and BLACK wires from the cable to the motor.
3. Attach jumper wires to the motor wires.
4. Connect the other ends of the jumper leads to the 10VDC – 14VDC source. If the awning moves in the wrong direction, reverse the leads. Maintain contact throughout the retraction process.
5. When the awning is closed, remove the jumper wires and reattach the cable wires to the motor wires. Be sure to match RED to RED and BLACK to BLACK.

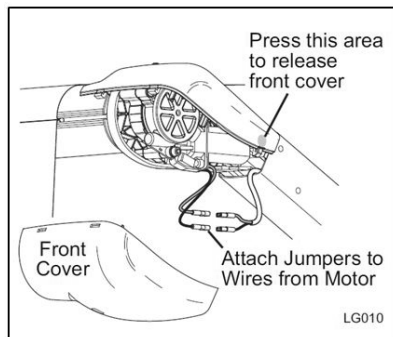

SECTION 4: VEHICLE OPERATION

- Snap the front cover onto the rear cover. Hang the cover on the top and swing it down until it clicks.

Carefree® TRAVEL'R Awnings (If So Equipped)

CAUTION

Power switch should be set to OFF whenever the awning is not being operated and during transport.

- Press the power switch to ON. This activates the Direct Response system and manual controls are active. When power switch is OFF, all functions are disabled.
- Press and hold the EXTEND switch to open the awning.
- Press and release the RETRACT switch. The awning will close completely. To interrupt retraction, press and release the RETRACT switch again, and the awning stops.

When the awning is retracted (rolled up) turn the power switch OFF.

Emergency Operation

If the original power source fails or is unavailable, there are emergency override connections (12V) available. The override can be used with a 10V-14V DC power source like a cordless drill battery or a car battery.



NOTE: If the awning is equipped with the Direct Response system, this procedure is not applicable. See the manufacturer's owner's manual for additional information.

WARNING

DO NOT USE A 110VAC POWER SOURCE FOR THE EMERGENCY OVERRIDE PROCEDURE! Doing so will permanently damage the awning! Do not use the Emergency Override without following the directions.

Locate and separate the quick disconnects located in the motor arm channel. Position the wires from the motor on the outside of the channel.

- Attach jumper wires to the motor wires
- Connect the other ends of the jumper leads to the 10VDC – 14VDC source. If the awning moves in the wrong direction, reverse the leads.
- Maintain contact throughout the retraction process. Hold the wires from the motor on the outside of the channel while closing the awning. This provides access for opening the awning.
- When power is restored, use the jumper wires and extend

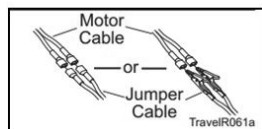
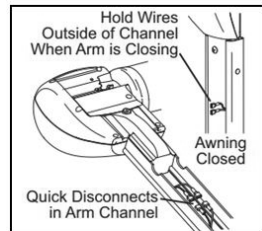

the awning to access the cable disconnects. Re-attach the disconnects and secure in the arm channel.

Additional Awning Operation Information

- When the fabric is rolled out, the Alumaguard or Uniguard may “bounce” creating a wave like motion in the canopy fabric. This creates the appearance of moving jerkily.
- With Uniguard, the awning sticks or hangs up. When Uniguard is installed with a vinyl canopy, the vinyl has a tendency to “cling” to the Uniguard when not used for an extended period of time. Open and close the awning in short bursts 2 or 3 times, the awning will then open normally.

Further care and cleaning information can be found in the Carefree® Awning owner’s manual, or visit their website at www.carefreeofcolorado.com.

SECTION 5: SLIDEOUT SYSTEMS

Notes:

ELECTRIC SLIDE ROOM(S) (IF SO EQUIPPED)

The slideout room system is designed for additional floor space and comfort. The mechanical components are gear driven. Electric powered slideout room systems have a manual override to allow you to extend or retract the slideout room(s) in case of a power loss. Make sure you have sufficient power available before operating your slideout system.

 WARNING

Make sure the interior slideout room path and the slideout room itself is clear of people and objects before operating. Keep away from the slide rails and gear assembly when the room is in motion. They may pinch or catch on loose clothing causing personal injury. **Failure to follow these instructions could result in serious injury or death.**

 CAUTION

These guidelines should be followed when using your slideout room:

- The recreation vehicle must be level before operating the slideout room. Water leaks and other problems could result if the slideout is operated without leveling the RV.
- Do not place excessive weight in the slideout room. It can cause the slideout room to malfunction and cause damage to the slideout.
- Do not over extend/retract the slide out room. Release the switch immediately once the room has been fully extended/retracted. Over extending/retracting the slide out room may result in damage to the stop rod and bracket.
- Additional support jacks are not needed under the slideout. Damage can occur to your slideout room from improper use of aftermarket support jacks.

 CAUTION

Make sure the slideout is in the closed position prior to hooking the unit to the tow vehicle.

Operating the slideout system:

- The auxiliary battery (customer supplied) must be fully charged** and connected. **If possible, the RV should be hooked up to 120-volt AC power** so the converter operates.
- The RV must be level and the **stabilizer jacks in the extended position**.
- Slideout switches are typically located inside the RV, either in the command center or on the wall.
- To extend the slideout**, locate the slideout control switch and press the OUT section of the switch; hold until the slideout room stops (travel time is approx. 25 seconds).

SECTION 5: SLIDEOUT SYSTEMS

- To retract the slideout, press the IN section of the slideout control switch and hold it until the slideout is fully retracted.

Operating the switch after the room is fully extended or retracted may damage the switch and motor.

After the slideout is extended, verify that the corners of the black rubber seal are set up correctly. The corners of this seal are cut at a 45° angle. The top of the outside seal must overlap the side of the seal to avoid the possibility of water penetration. On the inside seal, the side seal should overlap the top.



Slideout overlap-outside

Maintenance

⚠ WARNING

Do not work on your system unless the 12-volt DC (auxiliary battery, customer supplied) and 120-volt AC electrical systems (shore line power cord) have been disconnected.

Your slideout system will require very little maintenance. To ensure a long life of your slideout system, read, understand and follow these instructions. This system contains a pre-lubed bearing that is lubricated when the room is moved in and out. Do not spray oil or grease on the rails while the room is extended.

Troubleshooting the Slideout

If the slideout does not move when the slideout switch is depressed, follow these steps.

- Check the auxiliary battery (customer supplied) for a full charge and good wire connections.
- Check the 12-volt fuse or circuit breaker.
- Check for loose connections at the slideout motor.

If the slideout still will not operate, follow these steps.

- If the slideout is extended, refer to the section on operating the specific slideout system installed on your RV.
- If the slideout is retracted, leave it in that position.
- Contact your dealer or customer service for repair assistance.

SLIDEOUT SYSTEMS

Your RV may be equipped with one or more of the following slideout systems.

Schwintek Inwall slideout system

The in-wall slideout system requires no maintenance it will never require any adjustments. This system has two vertical columns. Each side has a drive motor located at the top of the column. The right and left hand motors remain synchronized by a circuit board.

CAUTION

Additional support jacks are not needed under the slideout. Damage can occur to your slideout room from improper use of aftermarket support jacks.

1. The auxiliary battery (customer supplied) must be fully charged and connected. When possible, the recreation vehicle should be hooked up to 120-volt AC power so the converter operates.
2. The recreation vehicle must be level and the stabilizer jacks in the extended position.
3. Slideout switches are typically located on the inside of the recreation vehicle, either in the command center panel or on the wall. To move the room out, press the OUT section of the switch and hold it until the motor stops (travel time is approx. 25 seconds

Some models may be equipped with a wireless remote control to operate the slideout. To operate the slideout using the remote:

- Press the on/off button to power on the remote.
- Select the slideout you want to operate by pressing the corresponding button.
- Press and hold the (extend/retract) arrow button to move the room in or out.
- Press the on/off button once more to power off the remote.

DO NOT try and time the end of the stroke by releasing the button early.

ALWAYS allow the controller to stop both motors before releasing the switch button.



NOTE: Do not operate the switch after the room is fully extended as damage can occur to the motor and/or switch.

Retracting slideout room

Press the IN section of the slideout control switch and hold it until the motor stops.



NOTE: Operating the switch after the room is fully retracted will damage the switch and motor.

Maintenance

WARNING

Do not work on your system unless the 12-volt DC (auxiliary battery, customer supplied) and 120-volt AC electrical systems (shore line power cord) have been disconnected.

SECTION 5: SLIDEOUT SYSTEMS

Your slideout system has been designed to require very little maintenance. To ensure a long life of your slideout system, read, understand and follow these simple instructions. This system contains a pre-lubed bearing that is lubricated when the room is moved in and out. Do not spray oil or grease on the rails while the room is extended.

Trouble shooting the Inwall slideout system

Checking Fuses: The inwall slide requires a minimum 30 Amp fuse. Check the load center for blown fuses and replace any if necessary.

If the fuse blows immediately upon replacement, there is a problem with the wiring to the inwall slide control box. A qualified service person should be called to check and repair.

Obstructions: Check outside for possible obstructions such as a tree, post or car etc. Check inside the vehicle for any obstructions such as luggage, furniture or open cabinets etc. Also check for smaller objects that may be wedged under the floor or in the sides of the unit. Remove any obstructions before proceeding.

Error Codes: Refer to the error codes section for codes and instructions on how to locate the inwall slide controller.

Low Voltage: The inwall slide controller is capable of operating the room with as little as 8 volts. But at these lower voltages the amperage requirement is greater. Check the voltage at the controller. If voltage is lower than 11 volts, it is recommended that the battery be placed on a charger until it is fully charged. It may be possible to “jump” the RV battery temporarily to extend or retract the room. Consult Customer Service before attempting to “jump” the auxiliary battery.

Only 1 Side Moving: The slide room has a separate motor to operate each side of the room. If only 1 side of the room is moving, then with another person’s assistance press the switch to extend or retract the room while pushing the non-moving side in the appropriate direction. On larger rooms it may be necessary to have 2 or more people pushing the room.

Non-moving side moved manually: Try to push the non-moving side in and out. If a motor shaft has broken then it will be possible to move that side of the room several inches by hand. Larger rooms may require several people to push.

Debris in the rack: Check all 4 gear racks on the side of the room for debris.

Do the status LEDs light? Locate the slide controller for the slideout in question. When the room slideout direction switch is actuated, do the status LEDs light up. Check this in both the extend and retract modes.

Manual override for the inwall slideout

The slideout system comes with an “electronic” manual override. In event the slide out does not extend or retract follow these steps to override the system which should allow the slideout to be retracted.



NOTE:Fuses for the slideouts can be found in the load center and may be designated

SECTION 5: SLIDEOUT SYSTEMS

1. Locate the slideout system controllers. There should be one for each slideout on the recreation vehicle. They are typically located in a forward section basement compartment, either on the forward wall or on the ceiling. In some models they may be behind a cargo lined panel.
2. The controller that has malfunctioned should have a flashing red LED indicating a halt signal fault (will flash 8 or 9 times).
3. Press the “mode button” six times quickly, then press a seventh time and hold for approximately 5 seconds.
4. The red and green LED’s will begin to flash indicating you are in override mode. Release the mode button.
5. Use either a wall switch, or one of the slide room switches located on the command center panel (depending on the slideout). Press the switch toward the word IN or RETRACT (printed next to the switch) and hold it until the unit comes in completely.
6. This will allow you to get the recreation vehicle to a service center to have the slideout malfunction diagnosed.

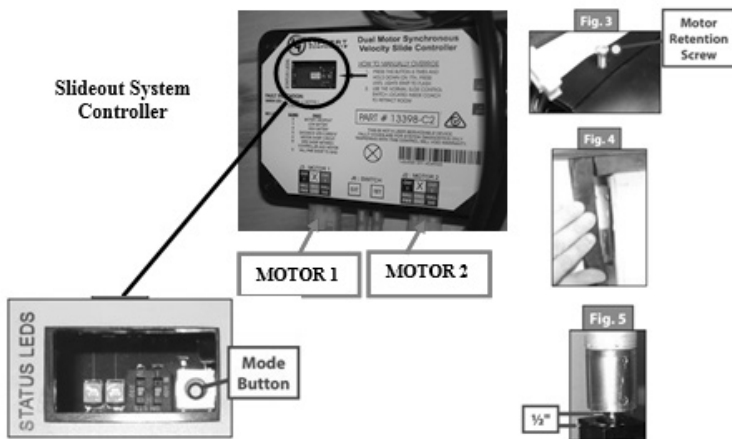

⚠ CAUTION

During this override procedure the motors are not synchronized. Visually watch the room, and if one side is moving significantly slower than the other (or not at all), immediately stop and call your dealer or Jayco Customer Service.

⚠ CAUTION

If the system stalls out before reaching end of stroke OR if the room does not close and seal tightly, call your dealer or Jayco Customer Service.

SECTION 5: SLIDEOUT SYSTEMS

Manually pushing in the slideout

1. Locate the slideout system controller
2. Unplug motor 1 and motor 2 connectors at the bottom of the slideout controller. This releases the motor brakes for each motor.
3. The slideout room can now be manually pushed in. Larger rooms may require several people to push or pull them.
4. Keep both sides of the slideout relatively even while pushing/pulling.
5. When the room is completely in, plug both motor connectors back into the control module. This will apply the motor brakes for road travel.

Disengage motors, manually retract the room and travel lock

6. Locate and remove the motor retention screw which can be found near the top of each vertical column (Fig. 3).
7. Bend back the wipe seal and visually locate the motor (Fig. 4).
8. Pull the motor up until it disengages (about 1/2 inch).
9. Repeat this process for both sides of the slide room.
10. Physically push or pull the room back into the opening, keep both sides relatively even.
11. The room must be travel locked to keep the room in place for road travel.

WARNING

DO NOT MOVE THE RV UNLESS THE MOTORS ARE PLUGGED IN TO THE CONTROLLER AND THERE IS BATTERY POWER TO THE RV. THIS SETS THE BRAKES ON THE SLIDEOUTS TO PREVENT THEM FROM MOVING DURING TRANSIT.

Error Codes

When an error code occurs during operation, the board will use the LEDs lights to indicate where the problem is. For motor specific faults the green LED will blink (1) time for motor #1 and (2) times for motor #2. The red LED will blink from 2 to 9 times depending on the error code. Error codes are as follows:

- 2 times **Battery drop out:** battery capacity low enough to drop below 6 volts while running.
- 3 times **Low battery:** voltage is below 8 volts at the start of a cycle.
- 4 times **High battery:** voltage is greater than 18 volts.
- 5 times **Excessive motor current:** high amperage, also indicated by (1) side of the slide continually stalling.
- 6 times **Motor short circuit:** motor or wiring to motor has shorted out.
- 8 times **Hall signal not present:** encoder is not providing a signal; usually a wiring problem.
- 9 times **Hall power short to ground:** power to encoder has been shorted to ground; usually a wiring problem.

When an error code is present, the board needs to be reset. Energizing the extend / retract switch will reset the board. Energize the extend / retract switch again to go back to normal operation.

Refer to the Schwintek Slide Room Operation Guide for further information. Contact Lippert or visit the Lippert website at www.lci1.com for additional troubleshooting information.

Flush Floor Slideout

For optimum performance, the slide-out system requires full battery current and voltage. Although the system is designed to be almost maintenance free, actuate the room once or twice a month to keep the seals and internal moving parts lubricated. Check for any visible signs of external damage after and before movement of the travel trailer.



NOTE: For long-term storage it is recommend the room be closed (retracted).

Trouble shooting the flush floor slideout

If the slideout does not move when the slideout switch is depressed, follow these steps:

- Check the auxiliary battery (customer supplied) for a full charge and good wire connections.
- Check the 12-volt fuse or circuit breaker.
- Check for loose connections at the slideout motor.
- If the slideout still will not operate, follow these steps:
- If the slideout is extended, refer to the following section on overriding the specific slideout system installed on your RV.
- If the slideout is retracted, leave it in that position.
- Contact your dealer or customer service for repair assistance.
- If the slideout extends crooked or only one side moves, follow these steps.
- Follow steps on overriding the specific slideout system installed on your RV.
- You may need to push the side that is not sliding to get it to retract all the way.
- Contact your dealer or customer service for repair assistance.

Manual Operation for the flush floor slideout

CAUTION

Always disconnect battery from system prior to manually operating system. Failure to disconnect battery can cause electricity to backfeed through the motor and cause serious damage to the system as well as void the warranty

The electric slide comes with a manual over ride system. Locate the crank extension under the inside of the frame (refer to Fig. 1 and 2).

This is where the crank handle (standard fifth wheel landing gear crank handle or 3/4" socket

SECTION 5: SLIDEOUT SYSTEMS

and ratchet fits on to allow the manual extension/retraction of the room (Fig. 3 and 4). Simply take the wrench, ratchet or drill with a nut driver and rotate it clockwise to retract and counterclockwise to extend slide-out.

It is important to note that you DO NOT need to attempt to disengage the motor as the actuator is “manual ready” Just hook up and crank.

Use EXTREME CAUTION when extending and/or retracting room using the manual override feature. It is possible to operate the slideout beyond the maximum extension and/or retraction and damage the slide components, slide room structure or trim components.

MANUAL OPERATION - THROUGH FRAME



Fig. 1-Through Frame Crank

Extension w/pin

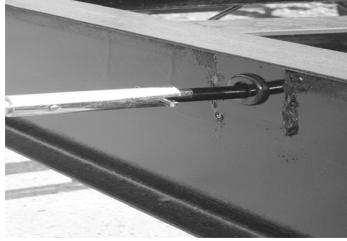

Fig. 2- Crank Handle

MANUAL OPERATION - IN FRAME



Fig. 3-Hex Head Crank Extension

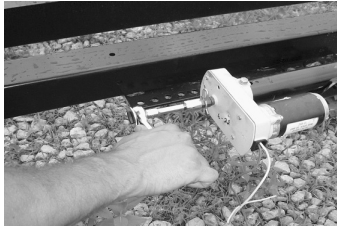

Fig. 4-Ratchet

⚠ CAUTION

The gears can be stripped out if the room is manually retracted/extended to its fullest extent and the operator continues to rotate manual override. Any damage due to misuse of the Manual Override feature will disqualify any and all claims to the Limited Warranty.

Power Gear® Slideout

The Power Gear® electric slideout is a rack and pinion design operated by a 12 Volt DC electric motor. It consists of 4 major components:

- Inner rail assemblies to support the room weight.
- A 12 Volt DC gear motor to operate the room using power from the onboard battery.
- A manual override that allows you to extend or retract the room in the event of a loss of power.

- A control that gives the user full control of room movement, in or out. The control has a sensing capability that stops the motor when the room is fully extended or retracted.



NOTE: For long-term storage: It is recommended the room be closed (retracted).

Electric Operation

⚠ WARNING

- Always make sure the slideout room path is clear of people and objects before and during operation of the slideout room.
- Always keep away from the slide rails when the room is being operated. The gear assembly may pinch or catch on loose clothing causing personal injury.
- Install transit bars (if so equipped) on the slideout room during storage and transportation.

FAILURE TO FOLLOW THESE INSTRUCTIONS COULD RESULT IN SERIOUS INJURY OR DEATH.

Extending the room

1. Level the unit.
2. Main Power switch at stepwell (locations may vary) must be ON.
3. Verify the battery is fully charged and hooked up to the electrical system.
4. Remove the transit bars (if so equipped).
5. Press and hold the IN/OUT switch in the OUT position until the room is fully extended and stops moving.
6. Release the switch, which will lock the room into position. If the slideout switch is held after the room is fully extended, the control will sense that the room has stopped and will shut the motor off after a few seconds.



Retracting the room

1. Verify the battery is fully charged and hooked up to the electrical system.
2. Press and hold the IN/OUT switch in the IN position until the room is fully retracted and stops moving.
3. Release the switch, which will lock the room into position. If the slideout switch is held after the room is fully extended, the control will sense that the room has stopped and will shut the motor off after a few seconds.
4. Install the transit bars (if so equipped).

SECTION 5: SLIDEOUT SYSTEMS

Manual Operation for the Power Gear slideout system

Your slideout system is equipped with a manual override that allows you to extend or retract the room in the event of a loss of power.

WARNING

When the motor brake is disengaged the slideout room WILL NOT lock into place; therefore, the room will not be sealed. When the room has been manually retracted, be sure to install the transit bars (if so equipped) and return the motor brake lever to its normal engaged position in order to seal and lock the room into position.

CAUTION

Always disconnect battery from system prior to manually operating system. Failure to disconnect battery can cause electricity to backfeed through the motor and cause serious damage to the system as well as void the warranty

CAUTION

The gears can be stripped out if the room is manually retracted/extended to its fullest extent and the operator continues to rotate manual override. Any damage due to misuse of the Manual Override feature will disqualify any and all claims to the Limited Warranty.



NOTE: If the room does not move when the switch is pressed, check the following:

- :Make sure the slideout system is turned on.
- Battery is fully charged and connected.
- Transit bars have been removed (if so equipped).

When these items have been checked and the room still does not move when the switch is pressed, follow the steps below to manually override the slideout room.

1. Turn the Main Power OFF. The override will not work if it has power going to it. Do not work on the system unless the battery is disconnected.
2. Locate the slideout controller. There are two versions of the controller.
 - a. **Version 1**, unplug the 6 pin wiring harness from the controller.
 - b. **Version 2**, remove one of the motor leads, either the motor I or motor II lead from the controller.
3. Locate the slideout motor (Fig. 1). It will be mounted to one of the slideout rails. If the RV has an underbelly or cover over the motor, these parts will need to be removed to

access the motor. In a bedroom slideout, it may be located under the bed.

4. Rotate the brake lever, on the backside of the motor, counter-clockwise (looking from the rear of the motor) about 1/8 of a turn to the released position (Fig. 2). This will release the brake that holds the room in place.
5. Locate the manual override for the slideout system (Fig. 1).
6. The room is now free to move. Using either a 5/8" or 3/4" wrench or socket, crank the room either in or out completely. If the slideout system is supplied with a gearbox override (optional), use the crank handle to move the room.
7. When the room is fully in (or out) have one person apply pressure to the wrench/ratchet and return the brake lever to its engaged position. This ensures the room is locked into a sealed position.
8. Install the transit bars (if so equipped) to the slideout room and take the unit to an authorized dealer for service.

Fig. 1 - Motor & manual override general location

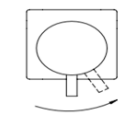
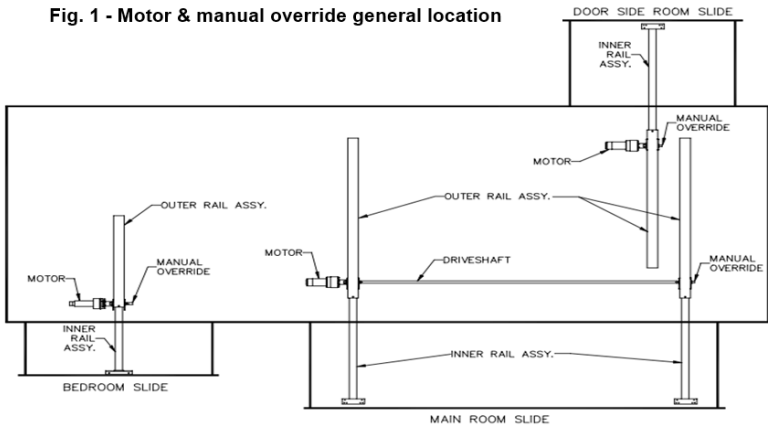

rotate approx. 30 degrees counter-clockwise to release motor brake

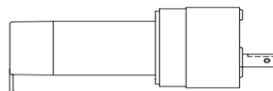

Brake lever



Fig. 2 - Motor brake lever

Refer to the Power Gear® Electric Slideout Operation Manual for detailed operation, safety and troubleshooting information.

SECTION 5: SLIDEOUT SYSTEMS

Norco Slideout

The Norco slideout system is a cable driven slide out.

- When the power switch is activated the cables guide the room in or out.
- Accu-Slide mechanism powers all 4 corners evenly keeping the room perfectly square.
- Motors and cables are hidden out of sight behind the interior fascia board around the slideout opening.
- Cables may stretch over time. Average stretch will be approximately 1/8" but it will not affect the function and does not require adjustment.
- Slideout runs off of the DC power in the RV.
- Rubber wipes prevent debris from entering the unit and precision actuation guides the bulb seals to close tightly.
- Self locking motor freezes the room in any position of travel.
- Slideout is supported by rollers or wear bars not the cables. Cables are used to keep the slideout balanced on the rollers.

If the room will not move:

Generally if the room will not activate, there is no 12V power to the drive motor. The motor is equipped with a hex drive override shaft. This drive can be activated using an electric drill and the flexible shaft provided with each unit (or use a ratchet to actuate the motor) to pull the room in or out. If the motor is functioning, check the room for obstructions.

Manually Moving The Room – Norco slideout

1. Locate the included flexible shaft in your owner's packet.



2. Attach flexible shaft to the 1/4" hex fitting on the end of the motor.

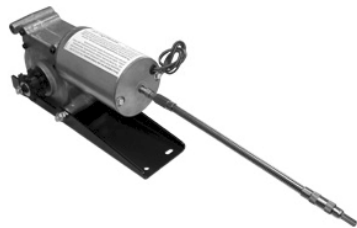

3. Attach 1/4" socket & ratchet, or drill to the other end, and turn in the proper direction to move the room.



4. If the cables tighten, and the motor is difficult to turn, **REVERSE THE DIRECTION. OVER-TORQUEING CAN HAPPEN, RESULTING IN SEVERE DAMAGE.**

Power Gear® Slim Rack Slideout System

The Power Gear® Slim Rack slideout is typically used for slideouts 144" long and longer.

- It is operated by a 12VDC electric motor.
- The system is equipped with a manual override allowing the room to be extended / retracted in the event of a power loss.
- The system has a controller (Fig 1) with programmable stops that stop the motor when the room is fully extended or retracted.
- The controller has the ability to detect faults for easier troubleshooting.
- A wall mounted touchpad allows room movement and provides end user feedback.



Fig.1 Slideout Controller

Operating the Slideout

The slideout will not function until the stops are properly set or faults are cleared.

A solid “ON” GREEN LED indicates room movement.

The RED LED indicates a fault or a problem with the system. (Refer to the *Fault Diagnostics / Troubleshooting section for additional information*).

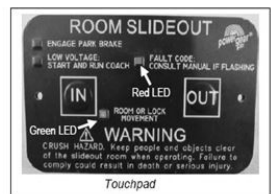

Prior to moving the slideout room set the parking brake.

To ensure ample voltage is being supplied to the slideout system motor, power should be supplied from one of the following sources:

- Attach the RV to shore power
- Have the motorhome engine running
- Turn on the generator

Extending the room:

1. Engine or generator must be running, or plugged into shore power.
2. Transmission must be in park (or neutral if applicable).
3. Set the parking brake and level the unit.
4. Remove transit bars (if equipped).

SECTION 5: SLIDEOUT SYSTEMS

5. Turn **ON** the on/off switch or key.
6. Press and hold the OUT button (See Fig 4 above). There will be a slight delay before the room begins moving, this is normal.
7. The GREEN LED should be solid ON when room is in motion.
8. Release the OUT button when the room is fully extended and stops moving.
9. Turn **OFF** the on/off switch or key.

Retracting the room:

1. The engine or generator must be running, or plugged into shore power.
2. Transmission must be in park (or neutral if applicable).
3. Set the parking brake and level the unit.
4. Turn **ON** the on/off switch or key.
5. Press and hold the IN button (See Fig 4 above). There will be a slight delay before the room begins moving, this is normal.
6. The GREEN LED should be solid ON when room is in motion.
7. Release the IN button when the room is fully retracted and stops moving.
8. Turn **OFF** the on/off switch or key.
9. Install transit bars (if equipped).

Fault Diagnostics / Troubleshooting:

This control has the ability to detect and display several faults. When a fault is detected the room movement stops and two different LEDs will flash in a pattern.

The RED FAULT CODE LED (Fig 4) will flash RED a number of times corresponding to a specific fault code. Refer to the Fault Codes Chart to determine the fault.

The GREEN ROOM MOVEMENT LED (Fig 4) will flash GREEN a number of times corresponding to which motor has the associated fault.

For example, if you see four (4) RED flashes and two (2) GREEN flashes it would indicate there is a motor fault on Motor 2.

There are two types of faults; MAJOR and MINOR. Faults must be cleared in order for the room to operate normally.

- **MINOR faults can be cleared by pushing and releasing the IN or OUT buttons on the wall touchpad (Fig 4).**
- **MAJOR faults must be cleared by pushing and releasing the SET STOPS/CLEAR FAULTS button located on the back of the wall touchpad. (Fig 2)**

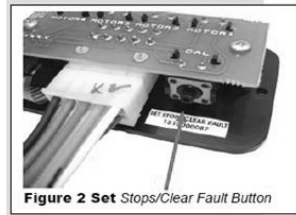

Figure 2 Set Stops/Clear Fault Button

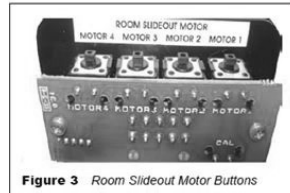

Figure 3 Room Slideout Motor Buttons



Figure 4 Touchpad

NOTE: For MAJOR faults, the control must be overridden by following the EMERGENCY RETRACT MODE in the **OVERRIDE MODES** section.

SECTION 5: SLIDEOUT SYSTEMS

Fault Code	Fault Type	Fault Codes		
		Description	Possible Cause	Possible Solution
1	Major	Stops not programmed	-Stops have not been set -Stops were cleared -Stops were improperly set	Steps need to be programmed by an authorized service facility.
2	Minor	System Fault	-Obstruction present -Excessive system drag	Run room in opposite direction. If it continues to move in the opposite direction, remove obstruction, excessive weight in room or repair of damaged component. If room stops moving in opposite direction, observe fault code and refer to this chart
4	Major	Excessive Battery Voltage	-Bad or loose connection -Defective harness -Open or shorted motor	-Check all connections at control box and motor -Check the harness for broken wires. -Put 12.0 VDC direct to the motor. If it does not run replace the motor.
6	Minor		Supply voltage to control box is 17.0 V DC or greater	Check 2-pin power connector at control box. If the voltage is 17.0 VDC or higher, contact O.E.M for power and ground supplies
Park brake LED flashing			-Parking brake not set (if applicable) -Ground signal lost at park brake control	-Set parking brake (if applicable) -Check for continuity to ground on wire plugged into park brake connector at control box
Low voltage LED flashing			Incoming violated to control box is below 12.0 VDC	Check 2-pin power connector at control box. If voltage is below 12.0 VDC contact O.E.M for power and ground supplies.

Preventative Maintenance:

Your Power Gear® slideout system is designed to require very little maintenance. To ensure long life of your slideout system read and follow these few simple procedures:

SECTION 5: SLIDEOUT SYSTEMS

- When the room is extended, visually inspect the slide rail assemblies. Check for excess buildup of dirt or foreign material; remove any debris that may be present.
- If the system squeaks or makes any noises, blow out any debris from the gear rack arms and apply a dry lubricant to prevent and/or stop squeaking.

Refer to the Power Gear® website (www.powergearus.com) CONTACT tab if you have any problems or questions.

Override Modes:

In the event of component failure or loss of system power, your slideout can be manually overridden and retracted for travel.

NOTE: At any time during the override procedure, the unit will exit this mode if the room has not been moved for two (2) minutes or if a fault is detected during room movement. The Fault Code (RED) and Room or Lock Movement (GREEN) LEDs will flash rapidly for 10 seconds to indicate the override procedure failed. After 10 seconds of flashing, the control will automatically default to FAULT CODE 1. Programming must be restarted.

NOTE: The room control will need to be re-programmed by an OEM authorized dealer after the system has been overridden.

Emergency Retract Mode:

Use this procedure when there is NO loss of power ore electrical problem with the system.

1. Remove the touchpad (Fig 4) from the wall.
2. Prior to clearing the MAJOR fault, record the number of RED & GREEN flashes observed on the touchpad (Fig 6). This information will help your dealer/service center in troubleshooting the slideout system.
3. Press and hold the SET STOPS/CLEAR FAULTS button on the back of the touchpad for five (5) seconds (Fig 2). Both RED & GREEN LEDs will be on solid while pressing this button. After 5 seconds, the GREEN LED will begin flashing and the RED LED will remain solid on.
4. The unit is now ready to retract the room. Press and hold the ROOM SLIDEOUT MOTOR buttons 1 and 2 on the back of the touchpad (Fig 3).

# of RED flashes	# of GREEN flashes

Figure 6

CAUTION

It is very important to note that during this procedure, the slideout control has NO stop locations. Use a second person to assist in determining when the room is retracted. Damage to the room can occur if the room is retracted too far.

Press the IN button on the front of the wall touchpad until the room is fully retracted. If one side of the room needs to retract further in order to get a good seal, press and hold the motor button (Fig 3) corresponding to ONLY the motor you want to move. Press the IN button on the front of the touchpad to retract the room the remainder of the way.

5. Re-install the wall touchpad.
6. Take the unit to an OEM certified dealer for repairs.

Manually Retract Room with Ratchet & Socket:

In the event that power is lost to the slideout motor(s) or the override mode above will not work, the room may be manually retracted using a ratchet and socket attached to the end of the coupler (Fig 11).

1. You need to gain access to the VERTICAL CHANNEL assembly from either inside or outside of the coach (whichever is more convenient). Remove the OEM trim and flange pieces on the slideout room box.
2. If applicable, remove the top screw from the bulb seal at the top of the VERTICAL CHANNEL (Fig 8).
3. Pull down the bulb seal and remove the motor cover (Fig 9). The motor seal may stick to the bulb seal.
4. Using a pick tool, remove the end of the retaining spring from the motor spring clip (Fig 10A). If not equipped with a retaining spring, loosen the motor retaining screw (Fig 10B).
5. Unplug the motor from the harness and remove the motor by lifting it up and out.
6. Repeat steps 1-4 for the other side.
7. Place a socket wrench with a 3 inch extension and a 5/8" deep well socket (Fig 12) through the motor access opening and seat the socket onto the coupler (Fig 13). One man alternating from side to side of the room can retract a 1500 lb. room with or without a ramp.



NOTE: 1 person on each side of the room with a ratchet and socket will expedite the process. Room moves ¼ inch for every 30 to 40 degree turn of the wrench.

8. Secure the room in place by either:
 - Re-installing the motors (making sure the end of the retaining screw is re-hooked to the motor spring clip (Fig 10A).**
 - Torque the motor retaining screw to 40 inch/lbs. (Fig 10B) and the motor retainer is fully engaged.**
 - Use a travel lock, (a 2x4 cut to size), etc.**
 - Refer to Fig 10A and 10B for proper seating of the motor.
9. Have the slideout room serviced by an OEM authorized dealer as soon as possible. Do not operate the room until service is complete as damage to the room may result.

SECTION 5: SLIDEOUT SYSTEMS



Figure 8 Removing the bulb seal screw

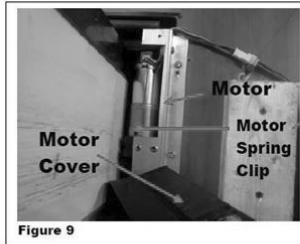

Figure 9



Figure 10A



Figure 10B

NOTE: Motor shown properly seated. No gap between mounting bracket and block.

Motor Retaining Screw

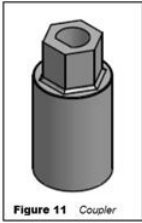

Figure 11 Coupler

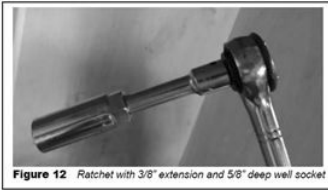

Figure 12 Ratchet with 3/8" extension and 5/8" deep well socket

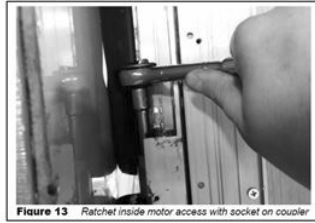

Figure 13 Ratchet inside motor access with socket on coupler

For further information refer to the Slim Rack In Wall Slide Out System Owner's Manual ,or visit Lippert's website @ <http://www.lci1.com/assets/content/support/manuals/pg-3010002679.pdf>

THE ELECTRICAL SYSTEM

The RV electrical system is comprised of two independent electrical systems. One operates off of 12-volt DC power and the other off of 120-volt 60hz AC power. All installations have been made in compliance with industry standards applicable on the date of manufacture. Because the electrical equipment and associated circuitry are engineered into a dedicated system specific to your RV, do not make unauthorized changes or add fixed appliances to it. **Changes or additions made after delivery may result in a hazardous condition.**

Service and/or modification of the electrical system should only be performed by qualified electrical technicians using approved materials, components, and methods meeting current safety and code requirements. Please consult your dealer's service department for assistance.

To read more about the various components incorporated into the RV electrical system, please refer to the information contained in your Warranty Packet.

Electrical System Maintenance

Before working on the electrical system; always disconnect the shore power cord, turn off the battery disconnect switch (if so equipped) and turn off the 120V main circuit breaker. Then disconnect the negative 12VDC battery terminal from the battery. Refer to *Battery Disconnect Switch & Load Center* sections.

⚠ WARNING

Use caution when using metal tools. If a tool contacts a battery terminal or metal connected to it, a short circuit could occur which could cause personal injury, explosion or Fire.

IN CASE OF AN ELECTRICAL FIRE

⚠ WARNING

Do not attempt to use water to put out an electrical Fire. Water can spread some types of Fire, and electrocution is possible with an electrical Fire.

HAVE EVERYONE EVACUATE THE RECREATION VEHICLE IMMEDIATELY.

- Switch the 120-volt main circuit breaker to the "off" position. **It is important that everyone knows where to find the main circuit breaker and how it operates.**
- Disconnect the negative battery cable(s) at the battery.
- Disconnect the power cord from the shore power receptacle.
- Turn "off" the generator (if so equipped).

Always have faulty or damaged wiring and electrical components repaired immediately.

COMMAND CENTER

The command center is typically located just inside the entrance door or in the living area of the recreation vehicle. It contains switches and controls for electrical functions for the RV. Depending on your model, the command center may be a panel complete with switches, or it can be a group of switch pods mounted to a recessed panel inside a cabinet. Some models

SECTION 6: ELECTRICAL SYSTEM

may have the switches and controls mounted directly to the wall in the living area or vicinity of the entrance door. In some cases, the systems monitor (which indicates tank levels and battery charge) may also be included on this panel (refer to the *Monitor Panel* section).



NOTE: Command center configurations and components may vary from model to model. Not all components listed may be available in your model.

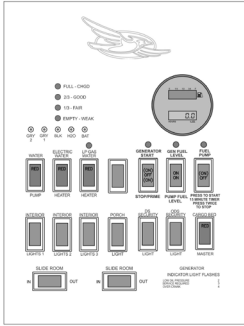

Command Center Panel



Command Center Panel W/Switch Modules



Mounted to wall

Command Center Panel:

Items found on this panel typically include (may vary by model):

- Fuel gauge and hour meter with switches for fuel pump and fuel levels
- Lighted red pump switch, lighted red water heater switches (electric & LP gas)
- Generator start / stop switch
- Tank heater switches
- Light switches for porch lights, exterior security lights, interior lights, awning LED lights, front cap LED accent lights
- Cargo bed red lighted master control switch
- Slideout control switches (press and hold to extend / retract)
- Awning control switches (press and hold to extend / retract)

Command Center Panel with Switch Modules:

Items may include separate switch modules and controls that are mounted to a recessed plastic panel. Items found on this panel typically include (may vary by model):

- Systems monitor with LED indicators for tank levels and battery charge status
- Systems monitor includes lighted red switches for pump and water heater
- Slideout switches (press and hold to retract / extend slideouts)
- Light switches for porch lights, exterior security lights, interior lights, awning LED

lights, power entry step

- Awning switches (press and hold to retract / extend awning)
- Auto leveling control panel (for leveling the recreation vehicle)
- Inverter panel (power switch with display)
- Generator start / stop control with hour meter
- Cargo bed red lighted master control switch
- Power bunk bed lift control switch
- Fuel gauge with fuel station on/off switch
- Speaker selector switch

Command Center Modules Mounted to the Wall

Some models may have the modules mounted directly to the interior wall of the vehicle. They are typically located near the entrance door. They may include any of the modules listed above.

GFCI RECEPTACLE

There is a ground fault current interrupter (GFCI) engineered into the electrical system. It is designed to reduce the possible injury caused by electric shock. The GFCI will not protect against short circuits or circuit overloads.

Test all GFCI receptacles monthly

- Push in the GFCI “TEST” button. The GFCI “RESET” button should pop out indicating the GFCI receptacle has been “tripped” and interrupted 120-volt power.
- Push in the GFCI “RESET” button to restore 120-volt power.

Contact your independent dealer for assistance if the GFCI “RESET” button does not restore 120-volt power and pops back out.

A “tripped” GFCI breaker indicates that abnormally high 120-volt current flow (a ground fault) was detected. A fault condition can be caused by faulty wire insulation, wet wiring inside an appliance, faulty electrical equipment connected to the circuit, etc. All ground faults must be repaired before use of the recreation vehicle.

HANDHELD WIRELESS REMOTE OPERATION

Your RV may include a handheld wireless remote control that will operate certain systems on the RV including awnings, slideouts, lights, landing legs, stab jacks and leveling.

Handheld Remote Control

The small handheld remote located in a holder at the entrance door can control certain functions on the RV wirelessly. Press the chrome button on the remote to bring up the keypad. You must enter a PIN code to operate devices in the RV. The default PIN code is 0,0,0,0. When you enter the code, a menu screen will appear to allow selection of devices (**Fig. A**).



Handheld wireless remote control located at entrance door

Programming the handheld remote

The PIN code was added to the handheld remote to provide personalized security for the remote, as well as serve as a safety feature to prevent inadvertent activation of functions. To utilize this set of instructions, the

SECTION 6: ELECTRICAL SYSTEM

unit ***MUST*** be equipped with a multi-function receiver and the handheld remote. These instructions do not apply to any other remote.

IMPORTANT: The figure numbers (1-15) referred to in the following instructions for the remote pertain only to the figure numbers shown above the handheld remote diagrams that follow.

Reset the handheld remote PIN code:

1. Press the “HOME” button (silver button at bottom of the remote) to turn the remote ON. (Fig 1).
2. Press and release “HOME” button five times.
3. Press “CONFIG” (Fig 1-A).
4. The remote will ask to reset the screen lock PIN code (Fig 2).
5. Press “Yes” (Fig 2-A).
6. The remote will display a message that the PIN has been reset (Fig 3).
7. Press “HOME” button and press “Set PIN” (Fig 4-A).
8. Enter a 4 digit PIN code (Fig 5).
9. Press “SAVE” (Fig 6-A).
10. Press “HOME” button.
11. When the keypad appears on the screen, enter the 4 digit PIN by pressing the corresponding numbers you entered at Step 7 (Fig 7).



NOTE: To start programming over, push and hold the “HOME” button for 5 seconds to turn the remote OFF. Push the “HOME” button again to turn the remote ON and restart the programming procedure.



Operating the handheld remote

1. The menu screen will show sets of four functions (Fig 8). Select a function or press “NEXT” for more options (Fig 8-A).
2. To return to the previous menu screen press “PREV” (Fig 9-A).

- Light functions can be turned ON and OFF by pressing “LIGHT” in the menu (**Fig 10-A**)
- Press a component button in the menu (**Fig 10**) to enter the function operation screen (**Fig 11**). To return to the previous screen press the chrome “HOME” button at the bottom of the remote.
- In the example (**Fig 11**), pressing and holding the left arrow retracts the awning, and pressing and holding the right arrow extends the awning. The graphic of the awning animates to show the awning is operating.



Important remote control operating information

- Never** attempt to operate a slide-out, awning, leveling, etc. from the handheld remote and a corresponding redundant switch at the same time. Doing so can blow one or more fuses on the LCI multi-function receiver.
- Immediately after operation of motor-reversing components using the handheld remote, there is an 8 to 10 second time period where all redundant switches for motor-reversing components are non-functional.
- The “Light” button on the handheld remote always controls the “Exterior Light” or “Exterior Light 1” circuit. This is the circuit that operates the awning light (main awning light on models with more than one awning), step light, etc. This circuit does **not** have “soft start” functionality. (if it is turned “ON” with the remote, it must be turned “OFF” with the remote)
- If the awning light (main awning light on models with more than one awning), step light, etc. are turned “ON” with the handheld remote, they **MUST** be turned “OFF” with the handheld remote. The redundant ON/OFF switch will not turn “OFF” main awning lights that were turned “ON” by the handheld remote.
- Likewise; if the awning light (main awning light on models with more than one awning), step light, etc. are turned “ON” with the redundant ON/OFF switch they **MUST** be turned “OFF” with the redundant ON/OFF switch. The handheld remote will not turn “OFF” main awning lights that were turned “ON” with the redundant ON/OFF switch.
- On models with two power awnings, the lights on the second awning are secondarily controlled by a lighting conversion relay and are programmed to operate as “Exterior Lights 2”. This circuit has “soft start” functionality. The second awning (secondarily controlled by a lighting conversion relay) can be operated by both the handheld remote and the redundant ON/OFF switch in any order at any time.

SECTION 6: ELECTRICAL SYSTEM

- G. The handheld remote will enter “Sleep Mode” after 60 seconds of inactivity. Press the “HOME” button to wake it up.



NOTE: Redundant switches would be those switches located in other places like the touchscreens, WiFi app or the command center panel switches.

Calibrating the handheld remote

This procedure affects the location the device perceives was touched where it actually clicks. Using a stylus will provide the device with a more accurate point and may ease operation. If the device is not accurately responding to the user then follow the procedure below.

1. Press the “HOME” button 10 times (**Fig 12-A**).
2. Press the 3 crosshair targets as accurately as possible (**Fig 12-B**).
3. Press 3 more confirmation cross hair targets as accurately as possible (**Fig 13-A**).
 - A. If all crosshairs are tapped accurately the screen will display “Good Stability” (**Fig 14**). Press the “HOME” button to return to the main screen and continue operations.
 - B. If the crosshairs are not tapped accurately the screen will display a message stating “Bad Calibration Tap to Restart” (**Fig 15**). If this happens press anywhere on the screen to restart the procedure.



TESTING THE CAMPSITE POWER CONNECTION

The campsite 120-volt power receptacle(s) should always be tested for proper functionality prior to plugging the recreation vehicle shore power cord into it.

Campsite 120-volt power receptacles can be tested using a digital multimeter or a dedicated circuit analyzer. Dedicated circuit analyzers plug directly into the campsite power receptacle and minimally test for open neutral, open ground, and correct polarity. Polarity indicators can be purchased in most electrical and hardware stores.

⚠ WARNING

Do not hook up the power cord to any receptacle until you have verified proper polarity and grounding.

DO NOT plug the shore power cord into a campsite receptacle(s):

- That has reverse polarity
- With non-functioning ground circuits
- That shows outward signs of heat damage.

Doing so may result in property damage or serious injury. Damage or injury resulting from connection to malfunctioning or improperly wired power sources is not covered by your recreation vehicle warranty.

⚠ WARNING

- Do not use any cheater plug, adapter or extension cord to reconfigure incoming AC power or break the continuity of the circuit connected to the grounding pin.
- Do not connect the power cord into an outlet that is not grounded, or adapt the power cord plug to connect it to a receptacle for which it is not designed.
- Do not remove the grounding pin to connect to a non-grounded receptacle. Removal of the ground pin disables an important safety feature designed to prevent shock and electrocution hazards.
- Do not connect the power cord to an extension cord. Use of an improper extension cord will cause overheating of the cord as well as potentially causing premature failure of the AC equipment.

It is the responsibility of the owner of the electrical receptacle to ensure that the receptacle is properly wired and grounded. Reverse polarity and/or improper grounding of your RV can cause personal injury or death.

CONNECTING THE POWER CORD

⚠ WARNING

Plugging the shoreline power cord into an incorrectly wired power source could damage the recreation vehicle electrical system and result in severe or fatal injury.

Always test the external power source (i.e., the campsite power receptacle or electrical box) with a ground monitor before connecting your power cord to it. If the ground monitor indicates ‘reverse polarity’ or an ‘open ground’ **DO NOT** connect the power cord.

To help prevent power surges from damaging the connected loads, please follow these instructions when hooking up to the external power source:

SECTION 6: ELECTRICAL SYSTEM

1. Turn “off” the load center main 120-volt circuit breaker.
2. Carefully extend the entire length of the power cord (approximately 25’-35’) from the electric cable hatch to the external power source.
3. Plug the power cord into the receptacle. Be sure all the power cord prongs are properly plugged into the receptacle.
4. Return to your RV and turn “on” the load center main circuit breaker.

The shore line power cord should be unplugged when the recreation vehicle is left unattended. If something would happen to the electrical system, this may help limit potential damage.

When you are ready to leave, reverse the power cord connection process. Use care to prevent damaging the power cord electrical connection pins when connecting or disconnecting the shore line power cord. Grasp the plug to remove the power cord from the outlet; do not unplug it by pulling on the cord.

Maintenance

Inspect the power cord for cuts, cracks and worn insulation. Have the power cord replaced immediately if these symptoms are noticed.

WARNING

The power cord must be fully extended when in use and not left coiled in the electrical compartment or on the ground. If the power cord is left coiled, it may potentially create enough heat to melt its protective casing..

INVERTER (IF SO EQUIPPED)

Your recreation vehicle may be equipped with a factory installed inverter that converts 12-volts DC to useable 120-volts AC and supplies continuous AC power to the appliance plugged into it. It is important that you familiarize yourself with the inverter function and operation. The inverter should be “off” when not in use.

The factory-installed inverter is not intended for use with medical device(s).

If your recreation vehicle is equipped with a residential style refrigerator, the inverter may be used to supply the 120-volts AC necessary to power the refrigerator. The inverter has been carefully selected to provide proper power to operate the refrigerator safely.

Inspection and maintenance

If the inverter is not functioning, check the fuse protecting the inverter input. If you have further concerns contact your dealer. **There are no customer serviceable parts inside the inverter case and the manufacturer’s warranty will be void if the case has been removed.**

The inverter cooling fins and the cooling fan should be kept clear of any obstructions.

CONVERTER

The power converter (located in the Load Center) converts 120-volt AC power to useable 12-volt DC power when the shore power cord is connected to an external power source.

The converter has a built-in protective thermal breaker that will shut it down should overheating occur. Overheating can be caused by operating the converter above its maximum power output for an extended period of time, or by an obstruction to its ventilation air flow. To reduce converter heat build, keep unnecessary 12-volt lights and motors turned “off”.

Keep the converters cooling fins and fan clear of obstructions.

Charge Wizard Operation

The converter has (3) possible charging modes; NORMAL, BOOST and STORAGE. The charge wizard will automatically select the best mode to charge your battery.

A green LED next to the wizard mode button will indicate by flashes, which mode is currently being used.

NORMAL MODE: Green LED flashes once per second; battery is between 50% and 90% charged. Green LED will flash 2-3 times per second; battery is 90% charged. Output voltage is 13.6VDC and the converter is safely completing the charge of the battery.

BOOST MODE: Green LED is on solid. Output voltage is 14.4VDC to rapidly charge the battery up to 90% of full charge.

STORAGE MODE: Green LED flashes every 6-8 seconds. Output voltage has been reduced to 13.2VDC; the RV battery is fully charged and converter is maintaining the charge.

MANUAL MODE (Not recommended): The wizard mode button is used to override the charge wizard. Refer to the converter owner's manual for additional information.

REVERSE BATTERY PROTECTION: Reverse polarity fuse(s) provide protection for the converter when a battery is used. If the battery is connected backwards to the fuse board a fuse will blow preventing damage to the converter. Four easily accessible fuses are located next to the wizard button. Replace with fuses of the same type and rating.

Inspection and maintenance

If the 12-volt power converter is not working (auxiliary battery not being charged) check the reverse polarity fuse(s) in the Load Center. **There are no customer serviceable parts inside the converter case and the manufacturer's warranty will be void if the case has been removed.** If you have further concerns contact your dealer.

12-VOLT DC SYSTEM

The majority of your recreation vehicle lighting is powered by 12-volt electricity. The 12-volt DC system is composed of components that will operate when the following conditions are met:

- Power is supplied by the tow vehicle alternator when the engine is running and the 7-way trailer plug is connected. This powers the RV's running lights, brake lights, turn signals and brakes. In addition, the 7-way trailer plug provides a common ground and a 12-volt charge line to charge the auxiliary battery.
- The converter will supply interior 12-volt DC power when the power cord is plugged into campground power. The converter will also charge the RV battery in most situations. (Refer to Battery Disconnect)
- The auxiliary battery powers many interior 12-volt components including the lighting fixtures, water pump, 12-volt motors, 12-volt appliances, etc. It also powers the breakaway switch.

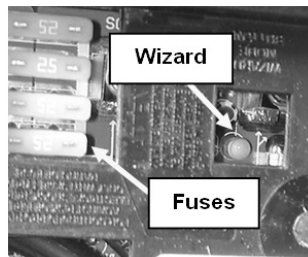

Wizard Button & Reverse
Protection Fuses

SECTION 6: ELECTRICAL SYSTEM

12-VOLT FUSE PANEL

The 12-volt fuse panel is labeled to indicate fuse sizes, positions and the components powered. At the beginning of camping season, inspect all the 12-volt fuses and replace as needed. Fuses are located in the Load Center

Replacing a fuse

Before replacing a fuse, always turn off electrical components protected by it.

1. Disconnect the shore power cord.
2. Disconnect the auxiliary battery main negative battery cable.
3. Remove the fuse panel cover to check fuses.
4. Pull the fuse straight out of the fuse block. If the fuse is not blown, something else must be causing the problem. Please contact your dealer for further assistance.
5. Insert a new fuse of the same specified voltage, amperage rating and type in the original location.

The fuse panel label should be kept permanently affixed to your recreation vehicle. Fuses will not offer complete protection of the electrical system in the event of a power surge or spike.

WARNING

Replacement fuses must be of the same voltage, amperage rating and type. **Never use a higher rated replacement fuse;** doing so may cause a fire by overheating the RV wiring.

12-VOLT DC OUTLET

There may be one or more 12-volt DC power outlets in your recreation vehicle. When the 12-volt DC outlet is used as a power source for an electric appliance, make sure the appliance operates on 12-volt DC power and that it consumes less than 60 watts (5 amps) of power.

WARNING

Keep the protective dust cap on the 12-volt DC outlet when not in use to prevent ingestion of foreign material and potential short circuit conditions.

AUXILIARY BATTERY (CUSTOMER SUPPLIED)

WARNING

Do not store anything inside the battery compartment(s) or near the batteries that could touch the battery or battery cable terminals. Contact with the battery or battery cable terminals could cause an electrical short circuit, discharge the batteries, or start an electrical fire.

The combined 12-volt DC loads in your recreation vehicle become more than the converter can produce. This demand can be met by using an auxiliary battery for a limited period of time. The 12-volt system is designed for usage with a Group 27, deep cycle battery.

Dry camping

The auxiliary battery should be fully charged prior to dry camping. If the auxiliary battery is not being recharged and power is being drawn from it, it will eventually discharge. A battery will discharge at a faster rate as its energy level becomes depleted. Plan your electrical usage accordingly. You can test the auxiliary battery voltage using a volt-ohm meter (customer supplied).

A fully charged auxiliary battery will read 12.7 volts DC and 1.265 specific gravity at 80°F (32°C). The auxiliary battery is considered discharged at 11.89 volts, and dead at 11.65 volts. If the voltage drops below those levels, irreversible damage can occur. Typically, a deep cycle battery has an amp-hour rating of 75-100 amps.

If you run the furnace and refrigerator simultaneously, you will be using approximately (12.0 + 3.0) 15.0 amps per hour. This does not include any 12-volt lights, or any other 12-volt component. If the furnace and refrigerator in this example operated constantly, a 75 amp-hour battery would become fully discharged in 5 hours ($75\text{ah} / 15\text{a} = 5\text{h}$).

The auxiliary battery should be installed in parallel with the battery in your tow vehicle. When the 7-way trailer plug is connected, both batteries power the RV. Do not allow it to discharge your tow vehicle battery below the level required to start the engine. To prevent this from occurring, disconnect the 7-way trailer plug or install a battery isolator. When the tow vehicle engine is operating with the RV connected, the tow vehicle charging system will charge both batteries.

Replacement and maintenance

Some equipment in your RV will draw small amounts of current even when turned OFF. To prevent the auxiliary battery from being discharged when your RV is not connected to shore line power, disconnect the auxiliary battery negative cable at the battery. During storage, it is important to check the voltage monthly and recharge the auxiliary battery as needed. If you remove the auxiliary battery from your RV, store it in a dry, cool area per the manufacturer's instructions.

When it is time to replace the auxiliary battery, **replace it with a Group 27 deep cycle battery only**. Do not reverse the positive and negative battery cables (doing so will blow the reverse polarity fuse(s) that protect the converter).

WARNING

Keep sparks, cigarettes and flames away from the batteries as the hydrogen gas they create may explode. Do not connect a booster battery or other power source that outputs more than 14.2-volts DC to the motor home batteries. Use adequate ventilation when charging or using batteries in an enclosed space. Remove metal jewelry and always wear eye protection when working around batteries.

⚠ WARNING

Do not allow battery electrolyte (acid) to come into contact with skin, eyes, fabric or painted surfaces. Electrolyte is a sulfuric acid solution that could cause serious personal injury or property damage. If your hands, eyes, clothes or the painted surface of your motor home are exposed to electrolyte, flush the exposed area thoroughly with water. If electrolyte gets in your eyes, immediately flush them thoroughly with water and get prompt medical attention.

For more information

Please contact the battery manufacturer for additional information on the auxiliary batteries.

***BATTERY ISOLATOR FOR YOUR TOW VEHICLE
(CUSTOMER SUPPLIED)***

You may want to consider the installation of a battery isolator on your tow vehicle as a convenience feature:

- It receives current from the tow vehicle alternator and controls distribution of energy to both the RV auxiliary battery and the tow vehicle battery.
- It serves as a check valve to prevent energy from being drawn from your tow vehicle chassis battery (so you can start your tow vehicle engine).

Your dealer can assist you with the selection, purchase and installation of this aftermarket part. than 60 watts (5 amps) of 12-volt power. To prevent short circuits do not allow metallic foreign matter to get into the 12-volt DC outlet.

BATTERY DISCONNECT SWITCH (IF SO EQUIPPED)

The Battery Disconnect switch is located in an enclosed exterior compartment typically at the front of the recreation vehicle. Depending on your model RV, it will have one of two styles of disconnect switches. Contrary to its name, the Battery Disconnect does not switch off all power to the batteries or the entire RV. The switch only shuts off the 12VDC power to the main 12V fuse panel, and the interior of the vehicle. Batteries can still be trickle charged by the converter, and there will still be power to the landing legs on Fifth wheels and certain other devices.

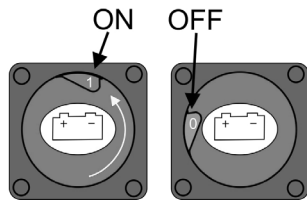

Rotating Dial Disconnect Switch

When this switch is ON, there will be a green area visible along with a “1” (one) at the top of the switch. To turn the switch OFF, turn it counter-clockwise until you see red area along the left side of the switch showing a “0” (zero).

Lever Type Disconnect Switch

The red lever switch has a detent on it that keeps it attached to the panel. This lever can be removed, so the lanyard



Battery Disconnect Switches
Switch appearance may vary by model

holding the lever keeps the key from getting lost. Operation is similar in operation to the dial switch above, turning the lever counter-clockwise turns off all 12VDC power to the fuse panel in the RV.

LOAD CENTER

The Load Center contains 12VDC fuses and 120VAC circuit breakers for almost all of the electrical appliances and circuits in the RV. The 120V Main Breaker (if so equipped) is located in this panel and will turn off all 120-volt power to the recreation vehicle. The load center is a hinged panel typically attached to a cabinet face in the main living area. Locations will vary by model. Refer to the diagram inside the Load Center for specific fuse assignments. Most load centers contain the same components, but they may be positioned differently. Not all load centers will include a main breaker.

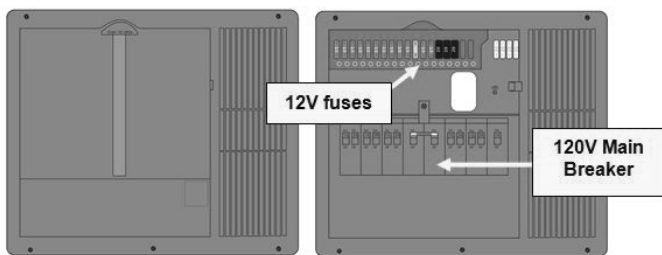

Typical Load Center Exterior Panel

50A Load Center Panel w/120 volt Main breaker

APPROXIMATE ELECTRICAL LOAD RATINGS

12 Volt System	
Aisle Lights	1.0 AMP
Baggage Compartment Lights	1.4 AMPS
Decorative Wall Lights	1.5 AMPS
Dinette Light	4.5 AMPS
Exterior Entertainment Center	5-7 AMPS
Fantastic Fan	1.5 AMPS
Fluorescent Double Lights -12"	2.0 AMPS
Fluorescent Double Lights -18"	2.5 AMPS
Furnace	12.0 AMPS
Generator Start	95.0 AMPS*
Halogen Light	1.7 AMPS
Illuminated Switch	.125 AMP
Inverter	variable
Leveling System	95.0 AMPS*
LP Detector	.125 AMP
Map Light	1.5 AMPS
Porch Light	1.5 AMPS

SECTION 6: ELECTRICAL SYSTEM

Power Awning	10.0 AMPS
Power Vent	5.0 AMPS
Refrigerator	3.0 AMPS
Shower Light	1.4 AMPS
Step Cover	10.0 AMPS
TV Plate/Antenna Booster	1.0 AMP
Vanity Light	4.2 AMPS
Water Heater	6.0 AMPS
Water Pump	7.0 AMPS

*Momentary Load

12 Volts: Labeled watts divided by 12 = Power consumed in AMPS

120 Volt System	
Air Conditioner	18 AMPS
Coffee Maker	6-12 AMPS
Converter (each)	8 AMPS
DVD System	3 AMPS
Fireplace	12 AMPS
Hair Dryer or Curling Iron	10-14 AMPS
Microwave	12 AMPS
Refrigerator	6 AMPS
Satellite Receiver	2 AMPS
TV	2-4 AMPS
Vacuum Cleaner	8 AMPS
Washer/Dryer	12 AMPS
Water Heater	12 AMPS

120 Volts: Labeled watts divided by 120 = Power consumed in AMPS

120-VOLT (50 AMP) AC SYSTEM (IF SO EQUIPPED)

The 50 amp 120-volt 60hz AC electrical system can be powered by an outside 120/240-volt 60hz utility service like those commonly found in campgrounds or by 120/240-volt 60hz generator power. The entire system is designed to operate on 2 legs of 120-volt power at a maximum current flow of 50 amperes per leg.

Exposure to voltages higher or lower than a nominal 120-volts, will damage or shorten the service life of the electrical system and appliances. The 50 amp 120-volt 60hz AC electrical system can be powered by an outside 120/240-volt 60hz utility service like those commonly found in campgrounds or by 120/240-volt 60hz generator power.

The following electrical components will only operate when connected to 120-volt power: air conditioner(s), refrigerator, microwave oven, television(s), home theater system(s), water heater, washer, dryer, fireplace, electric stove, and appliances plugged into convenience receptacles.

⚠ WARNING

Circuit breakers and fuses will not offer complete protection of the electrical system in the event of power surge or voltage spike.

⚠ WARNING

Make certain the external power source you connect the power cord to is a properly wired **50 amp NEMA 14-50** RV receptacle and not 240 volt AC.

50-AMP POWER CORD (If So Equipped)

⚠ WARNING

PLUG INTO 50-AMP SERVICE ONLY.

The 50 amp external utility power cord is commonly referred to as the “shore” power cord. It is designed to mate and properly function with 50 amp “shore” power receptacles available at most campgrounds.

The shore power cord is designed to continuously carry the 50 amp current flow required to power each leg of the electrical system. It also creates a critical ground connection between the vehicle electrical system and the campground shore power receptacle.

CALCULATING 50 AMP ELECTRICAL LOAD (If So Equipped)

When connecting appliances to the electrical system, remember that 120-volt power usage is limited to 50 amps per electrical system leg for a total of 100 amps. Be mindful of the fact that each operating appliance collectively places an added load on your 120-volt electrical system.

An unintentional “trip” of a circuit breaker may occur if you overload the recreation vehicle and/or campground electrical system. The amperage rating of individual appliances can be calculated by dividing appliance wattage consumed (normally listed on the appliance) by nominal design voltage (120 for a 120-volt appliance). For example: 1200 watts divided by 120-volts equals 10 amps.

Only connect the shore power cord to RV 50 amp 120/240 volt electrical power receptacles.

⚠ WARNING

- ❑ Do not hook up the power cord to any receptacle until you have verified proper polarity and grounding. Polarity indicators can be purchased in most electrical and hardware stores.
- ❑ Do not use any cheater plug, adapter or extension cord to reconfigure incoming AC power or break the continuity of the circuit connected to the grounding pin.
- ❑ Do not connect the power cord into an outlet that is not grounded, or adapt the power cord plug to connect it to a receptacle for which it is not designed.
- ❑ Do not remove the grounding pin to connect to a non-grounded receptacle. Removal of the ground pin disables an important safety feature designed to prevent shock and electrocution hazards.
- ❑ Do not connect the power cord to an extension cord. Use of an improper extension cord will cause overheating of the cord as well as potentially causing premature failure of the AC equipment.

It is the responsibility of the owner of the electrical receptacle to ensure that the receptacle is properly wired and grounded. Reverse polarity and/or improper grounding of your recreation vehicle can cause personal injury or death.

120-VOLT CIRCUIT BREAKERS

The 120-volt AC circuit breakers located inside the load center protect all 120-volt wiring and components in the recreation vehicle from circuit overloads and short circuits. Should a circuit overload or short circuit occur the circuit breaker protecting the affected circuit will “trip” preventing the flow of electricity through that circuit.

If a circuit breaker trips, shut “off” the appliance on that circuit (i.e., power converter etc.) and allow the circuit breaker to cool down for a brief period of time. After the cooling down period, reset the circuit breaker by moving its lever “off” and then back to the “on” position. If the circuit breaker re-trips or frequently trips, contact your dealer to have the electrical problem diagnosed and repaired.

A circuit breaker identification label is permanently attached to the inside surface of the 120-volt Load Center. 120-volt circuit breakers are located in the sub-panels inside the cabinet above the driver seat.



NOTE: Load Centers may not always include a main circuit breaker.

⚠ CAUTION

Circuit breakers and fuses will not offer complete protection of the electrical system in the event of power surge or voltage spike.

Replacement

Only replace circuit breakers with those of the same specified type, voltage, and current rating. Never replace a circuit breaker with one listed at a higher amperage rating. Please contact your dealer for repair assistance when replacing circuit breakers.

WARNING

Replacement circuit breakers must be of the same voltage, amperage rating and type. Never use a higher rated replacement circuit breaker; doing so may cause a fire by overheating the RV wiring.

Maintenance

At the beginning of camping season, inspect the circuit breakers and replace as needed. Test by turning each circuit breaker “off” and back “on”. Circuit breakers are wearable parts and must be replaced as needed, as part of your RV maintenance. If you have any questions, consult your dealer.

A label is provided to explain the function of every 120-volt circuit breaker. This label is located on or near the appropriate load center or sub-panel and must remain permanently affixed to the recreation vehicle.

GENERATOR

The factory-installed generator will produce 120-volt AC power for use when camping in areas where shore power is unavailable. 120-volt power from the generator is output to the AC distribution center by way of a factory-installed automatic transfer switch. In the default mode, the automatic transfer switch connects the generator to the AC distribution center when the generator is operating and shore power is disconnected.

Be aware the generator, when operating, gives off carbon monoxide.



NOTE: Refer to the manufacturer's owner's manual for detailed operating and safety information.

WARNING

CARBON MONOXIDE IS DEADLY! Do not run the generator when your recreation vehicle is indoors or in a confined space. Asphyxiation or carbon monoxide poisoning hazards exist whenever generator exhaust gasses can accumulate.

Before starting the generator

1. Make sure the carbon monoxide detector is working.
2. Turn “off” air conditioners and all other appliances.
3. Check for fuel, exhaust and coolant leaks.

STOP the generator immediately if there is a fuel, exhaust or coolant leak and have it repaired!

 WARNING

CARBON MONOXIDE IS DEADLY! MOVING PARTS AND ELECTRICITY can cause severe personal injury or death. To reduce exposure to these hazards, **always disable AGS (if so equipped) before:**

- Sleeping in vehicle, unless vehicle has a working CARBON MONOXIDE detector.
- Parking vehicle in garage or confined space.
- Parking vehicle for storage.
- Servicing vehicle for storage.
- Servicing generator.
- Servicing batteries.
- Servicing appliances or electrical systems.
- Fueling the generator.

DO NOT run the generator or use the AGS AUTO ON or QUIET ON modes (if so equipped) when your RV is indoors or in a confined space. Asphyxiation or carbon monoxide poisoning hazards exist whenever generator exhaust gasses can accumulate.

To start the generator manually

1. Press the operation control switch to start the generator. (Depending on how cold it is, preheat can take up to 15 seconds).
2. The hour meter will monitor minutes of usage when the generator is running.
3. Before stopping the generator, turn off air conditioners and large electrical loads and allow the generator to run 3 to 5 minutes to cool down. Flip the red start/stop switch to stop.

For top performance and engine life, especially in colder weather, let the generator engine warm up for two minutes before connecting (turning “on”) appliances.

 CAUTION

Excessive cranking can overheat and damage the generator starter motor. Do not crank for more than 20 seconds at a time. Wait at least two minutes before trying again. If the generator does not start after the third try, refer to the generator manufacturer’s user manual for more information.

Maintenance

With the exception of simple items such as normal maintenance (i.e., oil changes, etc.), all service work should be done by a repair facility authorized by the generator OEM. Improper adjustments can damage the generator and electrical appliances, and can result in a safety hazard. If any discrepancy or problem is noted, contact your dealer for assistance.

Exercising Your Generator – it's also very important to run your generator regularly, to keep everything in good working order and in the case of gasoline sets, to avoid fuel varnishing, which can affect performance, if the generator is stored for an extended time.

Lack of exercise can cause moisture build-up and fuel system degradation that make it run poorly. In fact, in as little as 30 days, the fuel in gasoline-powered generators can begin to gum and varnish the fuel system. Fuel varnishing results in hard starting and surging. (A surging generator never settles at a stable operating speed.)

To prevent such problems, it is recommended to run gasoline generators at a minimum of 50 percent capacity (2000-watts, or one air conditioner for a 4000-watt set) for two hours once every four weeks. This is necessary to help keep moving parts lubricated, expel moisture and control fuel varnishing in the carburetor. A long two-hour exercise period is preferable to several short periods. While traveling, this can be accomplished by running the air conditioning.

For more information on generator operation and maintenance, refer to the generator owner's manual, or the website at <http://www.powersystems.cummins.com>.

SOLAR PREP (IF SO EQUIPPED)

Your recreation vehicle may be wired with a (exterior) plug in that will allow the batteries to be trickle charged using a free standing solar panel. In most models, the solar panel kit is a customer purchased and installed option. The solar plug location will vary by model, but may be located either on the sidewall, on the A-frame of the vehicle or in the outside utility center. There are capped off wires located in the area of the battery. These wires are the battery charging wires. Once these wires are properly connected to your battery, you will then be able to plug the solar panel into the charging port.

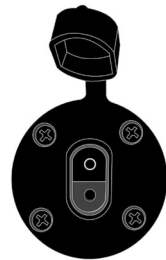

Solar Plug

When the system is connected properly, the solar panel will supply power to the battery, the battery will supply power to the converter, and the converter will supply power to all the 12V systems as needed.

LED DECORATIVE LIGHT STRIPS (IF SO EQUIPPED)

Some models may include decorative LED light strips which may be installed on the awning or on the front cap. When the awning light switch is turned on, these LED light strips illuminate. Instead of the awning light switch, the front cap LED strip lights may be controlled by a separate switch located next to the fifth wheel hitch at the front of the RV.

REPLACING LIGHT BULBS

Before replacing a bulb, be sure the light is off. Do not touch the glass part of the new bulb with your bare fingers. The skin oil left on the glass will evaporate when the bulb gets hot, the vapor will condense on the reflector and it will dim the surface.

Replacement light bulbs must be of the type, voltage and wattage listed on the lamp fixture. Use of incorrectly sized bulbs can overload lam circuits and may create a fire hazard by overheating the fixture.

SECTION 6: ELECTRICAL SYSTEM

Notes:

EXHAUST GAS FUMES

 WARNING

Avoid inhaling exhaust gases as they contain carbon monoxide, which is a potentially toxic gas that is colorless and odorless.

 WARNING

If you are in a recreation vehicle with either a nearby tow vehicle engine running or the generator (if so equipped) running there is a potential for exhaust fumes to filter back into the recreation vehicle.

To avoid breathing exhaust gases, follow these precautions:

- Always shut OFF the tow vehicle engine, generator engine (if applicable), etc., while refueling.
- Do not run the tow vehicle engine, generator engine (if applicable), etc., in confined areas, such as a closed garage, any longer than needed to move your RV in or out of the area.
- Windows should be closed while driving or running the generator (if so equipped) to avoid drawing dangerous exhaust gases into the RV.
- If you suspect that exhaust fumes are entering the RV have the cause determined and corrected as soon as possible.

The best protection against carbon monoxide entry into the RV is a properly maintained ventilation system and an active carbon monoxide detector. To allow for proper operation of the RV ventilation system, keep the ventilation inlet grill(s) clear of snow, leaves or other obstructions at all times.

See the Occupant Safety section of this manual for additional information on carbon monoxide safety.

PROPANE GAS SYSTEM

Propane or LP (liquefied petroleum) gas is a clean and efficient form of energy when proper handling and safety precautions are observed. The propane system in your recreation vehicle furnishes the fuel for cooking, heating and hot water. Propane can also be used as an alternative energy source for refrigeration

The propane fuel system is comprised of numerous components such as the propane container, hoses, the propane gas regulator, piping and copper tubing lines to each appliance.

Propane is heavier than air; the gas tends to flow to lower areas and will sometimes pocket in these low areas, such as the floor. Your recreation vehicle is equipped with a propane alarm (refer to the *Safety Precaution sections*, Combination Carbon Monoxide (CO)/Propane Alarm.)

SECTION 7: FUEL & PROPANE SYSTEM

WARNING

Propane cylinders should not be placed or stored inside RV. LP-gas cylinders are equipped with safety devices that relieve pressure by discharging gas into the atmosphere

Maintenance

Although your recreation vehicle has been carefully tested at the factory, and by your selling dealer for leakage, travel vibrations can loosen fittings. Have the propane system checked at all connections soon after the purchase of your recreation vehicle, and after the initial filling of the propane tanks.



NOTE: All propane lines have been checked with air pressure at the time of manufacture. Dealers are required to recheck and adjust pressure before retail delivery.

Continued periodic checks of the propane system at 5,000 miles of travel (or at least once a year), by a qualified propane service representative as part of your normal maintenance is recommended. Hand tighten the LP gas system valves only, do not use a wrench or pliers as over tightening may damage the valve seals and cause them to leak.

PROPANE LEAK TEST

Leaks may be found easily with a soapy water solution. Do not use a solution containing ammonia or chlorine when locating leaks. These products are corrosive to copper gas lines and brass fittings, which could result in deterioration of the copper and brass components.

Apply the soapy solution to the outside of the gas piping fittings. If a leak is present, the soapy solution will “bubble” at the leak point. If a leak is indicated, shut off the propane system valve(s) and contact an independent Entegra dealer or qualified propane service representative immediately.

DANGER

Never use an open flame to test for a propane leak. Do not check for leaks using products that contain ammonia or chlorine; these products can cause cracks to form on the metal tubing and brass fittings

PROPANE SAFETY PROCEDURE

Propane is a colorless and odorless gas that, in the liquefied state, resembles water. An odorant (usually a sulfur compound) is added as a warning agent. If you smell propane within the vehicle, quickly and carefully perform the procedure listed on the label below. This label has been placed in the vehicle near the range, for models equipped with a propane system

DANGER

IF YOU SMELL PROPANE

1. Extinguish any open flames, pilot lights and all smoking materials.
2. Shut off the propane supply at the container valve(s) or propane supply connection.
3. Do not touch electrical switches.
4. Open doors and other ventilating openings.
5. Leave the area until odor clears.
6. Have the propane system checked and leakage source corrected before using again.

Ignition of flammable vapors could lead to a fire or explosion and result death of serious injury.

Propane system label

When propane container is low, occasionally there may be a concentration of an onion or garlic-like odor, which can be mistaken for a propane gas leak. After the propane container has been refueled, the odor will usually disappear. If not, turn off the valve(s) and have the propane system inspected by your dealer or qualified propane service representative.

PROPANE GAS CONTAINER

Propane “container” is a general all inclusive term used to describe a vessel that is used for storage and delivery of propane gas. The most common of these are:

DOT (Department of Transportation) cylinders are transportable and are commonly used on recreation vehicles. The capacity of DOT propane cylinders is expressed in pounds. DOT propane cylinders are required to be removed from the recreation vehicle for filling and must be filled by weight by a qualified propane facility. DOT Propane cylinders are equipped with an OPD or Over Fill Protection Device designed to reduce the potential of overfilling. DOT propane cylinders are also equipped with an ACME service valve that is for connection of the TYPE 1 ACME pigtail hose assembly to the RV two-stage regulator.

The TYPE 1 ACME pigtail hose assembly is a wrenchless, user friendly, right hand threaded connector that features a thermally sensitive sleeve and excess flow device. Max output is 200,000 BTU/hr. It is used to connect propane cylinders to regulators, hoses and other fittings. It is not for use on gas grills and other low pressure devices. DOT cylinders equipped with an OPD and ACME type 1 service valve are identified by the triangular service valve knob.

DOT cylinders are typically marked with “top” or an arrow to indicate the correct orientation of the cylinder(s). Do not mount, store or transport any cylinder other than the in proper position indicated.

Be sure to securely re-install DOT cylinder(s) to the recreation vehicle after they have been removed for filling or replacement. Always close the service valve and install a dust cap or plug when transporting or storing disconnected containers whether full or empty.

ASME tanks are permanently mounted to the RV and are commonly used on RV motor homes.

The capacity of ASME tanks is expressed in gallons. ASME tanks are filled while the tank is attached to the motor home by a qualified propane facility. ASME tanks are

SECTION 7: FUEL & PROPANE SYSTEM

equipped with an automatic stop fill valve designed to reduce the potential of overfilling. ASME propane tanks are also equipped with a P.O.L. service valve that is for connection of the supply hose with a left hand threaded brass P.O.L. fitting from the tank service valve to the two-stage regulator. Not for use on gas grills and other low pressure devices.

WARNING

DOT propane cylinders must be transported and stored in an upright position so the pressure relief device will function properly. Laying a DOT propane cylinder on its side may potentially create a very dangerous situation.



NOTE: Tanks are to be installed, fueled and maintained in accordance to State and Local codes, rules, regulations or laws.

Propane is a true gas compressed into a liquid form. As the fuel is released from the container, it changes to vapor which is then used for the operation of the appliances. Propane will not run through the appliances in the liquid state.

Propane expands 1½ percent for every ten degrees of increase in temperature. It is imperative to leave sufficient space inside the container to allow for natural expansion of gas during warmer weather.

The main shut off valve must be kept closed at all times unless you are using the propane system or filling the propane cylinder. When the cylinder is disconnected from the hose, install the valve cover that is attached to the container.

Close the propane cylinder main shut off valve by hand tightening only. Use of tools creates a potential to over tighten the valve (damaging the interior seals on the cylinder valve seat). If this type of damage occurs, the cylinder will not close properly.

The following label should be kept permanently affixed to your RV.

<p style="text-align: center;">WARNING THIS SYSTEM IS DESIGNED FOR USE WITH PROPANE ONLY. DO NOT CONNECT NATURAL GAS TO THIS SYSTEM.</p> <p>BEFORE TURNING ON PROPANE:</p> <p>(A) BE CERTAIN APPLIANCES ARE CERTIFIED FOR PROPANE AND ARE EQUIPPED WITH CORRECT BURNER ORIFICES.</p> <p>(B) MAKE CERTAIN ALL PROPANE CONNECTIONS ARE TIGHT BY TESTING WITH SOapy WATER. ALL APPLIANCE VALVES ARE TURNED OFF, AND ANY UN-CORRECTED TIGHTS ARE CORRECTED.</p> <p>AFTER TURNING ON PROPANE:</p> <p>(A) LEAVE ALL CONNECTIONS, INCLUDING THOSE AT THE APPLIANCES, REGULATORS, AND CYLINDERS, UNCHANGED UNLESS TESTED RESPONSIBLY WITH SOAP WATER BY THE OCCUPANT. NEVER USE A LIGHTED MATCH OR OTHER FLAME WHEN CHECKING FOR LEAKS.</p> <p>(C) DO NOT LEAVE SYSTEM TURNED ON OR CONTAINERS CONNECTED UNTIL THE SYSTEM HAS BEEN PROVEN TO BE FREE OF ANY LEAKS.</p> <p>(D) COOKING APPLIANCES SHOULD NOT BE USED FOR SPACE HEATING.</p> <p>(E) WHEN THE CONTAINERS ARE DISCONNECTED, THE PROPANE SUPPLY LINE SHOULD BE CAPPED OR PLUGGED.</p> <p style="text-align: center;">AVERTISSEMENT CETTE INSTALLATION EST CONÇUE POUR LE PROPANE SEULEMENT. NE PAS LA RACCORDER À UN GAZ NATUREL.</p> <p>AVANT LA MISE EN SERVICE:</p> <p>(A) S'ASSURER QUE LES APPAREILS SONT CERTIFIÉS POUR LE PROPANE ET MUNIS D'ORIFICES DE SOUS-CORRECTIF.</p> <p>(B) VÉRIFIER L'ÉTANCHÉITÉ DE TOUTS LES RACCORDEMENTS AU PROPANE, LA FERRURE DE TOUTS LES RÉSERVOIRS D'APPAREILS ET L'ÉTANCHÉITÉ DE TOUTES LES BOÎTES NON RACCORDEES.</p> <p>APRÈS LA MISE EN SERVICE:</p> <p>(A) LAISSER TOUTES LES VÉLÉVRES.</p> <p>(B) L'OCCUPANT DOIT ÉProuver RESPONSABLEMENT L'ÉTANCHÉITÉ DE TOUTS LES RACCORDEMENTS, LES RÉSERVOIRS D'APPAREILS ET LES BOÎTES NON RACCORDEES ET AER SOUFFLER, EN Y APPLIQUANT DE L'EAU SAVONNEUSE. NE JAMAIS SE SERVIR D'UNE ALLUMÉE OU AUTRE FLAMME POUR LA DÉTECTION DES FUITES.</p> <p>(C) NE PAS LAISSER L'ALIMENTATION OUVERTE, NI LES RÉSERVOIRS RACCORDEES, AINSI QUE LES BOÎTES NON RACCORDEES ET LES APPAREILS AU PROPANE DE L'INSTALLATION.</p> <p>(D) LES APAREILS DE CUISINE NE DOIVENT PAS ÊTRE UTILISES POUR LE CHAUFFAGE DES LOCAUX.</p> <p>(E) LORSQUE LES RÉSERVOIRS SONT DECONNECTES, L'ALIMENTATION DE PROPANE DOIT ÊTRE OBTURÉE OU SOUILLÉE.</p> <p style="text-align: right;">JA, 105</p>
--

**"Use propane only" label
(Canada only)**

(Label appearance may not be exact)

Servicing or filling

Have the recreation vehicle checked for leaks at the connections on the propane system soon after the purchase and the initial filling of each propane cylinder. When you have a new

cylinder filled for the first time, make sure your propane supplier purges your new cylinder of trapped air. Otherwise, an improper mixture of gas and air will make it impossible to light your propane appliances.

 WARNING
Before entering a propane or fuel service station make sure all pilot lights are extinguished. Shut off gas to all appliances by closing the propane gas main shut off valve. Always shut OFF any engine before refueling. Do not smoke and do not operate other ignition sources while refueling.

No one should be inside and only the qualified propane service technician should be near the RV while the propane tank is being filled. The new propane container must be carefully purged for best performance and must **NEVER BE OVERFILLED**. The following label should be kept permanently affixed to your RV.

▲ DANGER
ALL PILOT LIGHTS, APPLIANCES AND THEIR IGNITORS (SEE OPERATING INSTRUCTIONS) SHALL BE TURNED OFF BEFORE REFUELING OF MOTOR FUEL TANKS AND/OR PROPANE CONTAINERS. FAILURE TO COMPLY COULD RESULT IN DEATH OR SERIOUS INJURY. AD-05

“Shut off for re-fueling” label
(Label appearance may not be exact)

The position of the propane container(s) and the hoses are critical to proper operation and propane flow. Follow these instructions to make sure your propane container(s) are connected properly.

 WARNING
The pigtail hose must be installed to avoid tension or pulling stress at either end of the hose. Keep the pigtail hose away from sharp edges of the cylinder collar, rigid corners, walls, doors or other compartment structures including the cover.

LP gas container overfill

Never allow your propane tank to be filled above the maximum safe level as indicated by the fixed liquid level gauge. Do not allow the visible gauge to be used for filling. Overfilling the propane container above the liquid capacity indicated on the container, could allow liquid propane to enter the system that is designed for vapor only creating a hazardous condition.

The following label should be kept permanently affixed to your RV.

 WARNING
If you suspect your propane container has been overfilled, contact your independent Jayco dealer or a qualified propane technician for assistance immediately. Do not attempt to service a propane container overfill yourself.

SECTION 7: FUEL & PROPANE SYSTEM

⚠ WARNING
DO NOT FILL PROPANE CONTAINER(S) TO MORE THAN 80 PERCENT OF CAPACITY. FAILURE TO COMPLY COULD RESULT IN A FIRE OR PERSONAL INJURY.

⚠ CAUTION
THIS PROPANE PIPING SYSTEM IS DESIGNED FOR USE WITH PROPANE ONLY. DO NOT CONNECT NATURAL GAS TO THIS SYSTEM. Securely cap inlet when not connected for use. After turning on propane, except after normal cylinder replacement, test propane piping and connections to appliance for leakage with soapy water or bubble solution. Do not use products that contain ammonia or chlorine. JA-178

“Do not fill to more than 80%” label
(Label appearance may not be exact)

Refer to your Warranty Packet for more information on the LP gas system components.

INSTALLING PROPANE CYLINDER(S)

⚠ WARNING

Ensure that all fasteners are secured before traveling.

Located in a recessed compartment or housing (if so equipped)

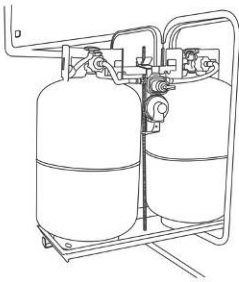

Two propane cylinders

1. Connect the 3/8” low-pressure hose to the outlet of the two-stage regulator.
2. Place the cylinder on the bracket in the recess compartment or housing and secure them so the outlets of the cylinder valves are facing the “sidewalls” of the compartment or housing (opposite of each other).
3. Mount the regulator on the center back wall of the compartment or housing so the vent is pointed downward.
4. Attach the 1/4” inverted flare x 18” Type-1 pigtail hose to the regulator inlet and the right hand swivel nut to the cylinder valve.

Main Supply Hose – Low Pressure

Attach the main supply hose from the regulator to the brass manifold fitting in the frame of the trailer. The swivel brass nut on the main hose will be your final attachment.



3/8" MPT x 1/2" Female
Flare Swivel

Main supply hose

Several things to remember each time the propane container is removed:

1. Check that ALL fittings are tight.
2. Check that ALL connections are tested with a propane leak detector (or soapy water) solution.

3. Open the main valve slowly to avoid a fast rush of propane to the excess flow valve causing propane freeze up. If you experience a propane “freeze-up,” close the main valve and wait at least fifteen (15) minutes before trying again. Refer to the regulator manufacturer’s operator manual.
4. Listen carefully - a “hissing” sound longer than one second may indicate a propane leak. If you feel there may be a leak present, close the valve and contact your dealer or qualified propane technician for repair assistance.

Replace all protective covers and caps on the propane system after filling. Make sure the valve is closed and the compartment door is securely latched.

Maintenance

Propane gas is normally non-corrosive - you need not worry about the inside of your container. However, the outside should be kept free from rust by a periodic coat of paint in a light reflective color. Rust, scratches and/or dents can affect the safety of the cylinder. Inspect the cylinder at regular intervals.

If there is a problem, have it evaluated by a qualified technician and discard it. DOT requires that a visual inspection be made prior to each filling.

Any cylinder that has been exposed to fire, leaks or seems damaged should not be refilled.

Do not attempt to repair any containers, container valves, regulator or appliances by yourself. Use only trained certified propane gas service technicians to perform repairs.

Propane cylinder recertification

If you have an older RV you should know that, according to Federal law, DOT cylinders may only be used for 12 years after their manufacture date (the number of years for certification may vary in your area). After that, the cylinders must be “recertified” which provides another five years of use.

The cylinders can be recertified every five years thereafter. Federal DOT (Department of Transportation) regulations require periodic inspections and re-qualifications of the propane cylinders. DO NOT USE damaged or rusted containers.

Verify with your local propane dealer that all required inspections and certifications have been completed on the propane cylinder within the correct time period before refilling the cylinder.

Have the LP system checked for leakage each time a cylinder is refilled or after any part of the propane system has been disconnected.

Hoses, Pipes, Tubes & Fittings

The hoses, pipes, tubes and fittings used in your propane system are designed to withstand pressures exceeding those of the propane system. However, because environment and time can both contribute to the deterioration of these components, they must be inspected for wear at regular intervals.

Be sure to inspect the hose before each season and when having the tank refilled. Look for signs of deterioration such as cracks or loss of flexibility. When replacing the hose or other propane components, make sure to always replace them with components of the same type and rating (check with your dealer).

Fittings are used to connect the various system components to each other. The P.O.L. fitting at the end of the propane supply hose is made of brass so that pipe sealants are not necessary to prevent leaking.

SECTION 7: FUEL & PROPANE SYSTEM

It also has a left-handed thread, which means that it is turned clockwise to remove, and counter-clockwise to tighten. The P.O.L. fitting has been designed to help restrict the flow of LP gas in the event of a regulator failure or hose malfunction.

PROPANE REGULATOR

WARNING

Propane regulators must always be installed with the regulator vent facing downward. Regulators that are not located in baggage compartments have been equipped with a protective cover. Make sure the regulator vent faces downward and (if applicable) the cover is in place to minimize vent blockage that could result in excessive gas pressure causing Fire or explosion.

Single stage regulator

Some models are equipped with a single stage regulator.

Two stage regulator

The two-stage regulator has the only moving components in the propane system. Its sole function is to reduce the pressure from the propane containers to a safe and consistent low operating pressure. The first stage reduces the container pressure to 10-13 lbs. The second stage reduces the 10-13 lbs. of pressure further to an operating pressure of 11" W.C. (water column) or 6.35 oz. of outlet pressure to your appliances.

The second stage is adjustable and will need to be adjusted by your dealer or qualified propane service technician for optimum performance (this adjustment should always be made with a properly calibrated manometer).

If the pressure is too high, it affects performance and safety; if the pressure is too low, your appliances will not operate correctly.

If your recreation vehicle is equipped with the "automatic" two-stage regulator, with both cylinders full of propane, turn the lever on the regulator towards the cylinder you wish to use first. This will now be the "supply" cylinder and the other the "reserve." Slowly open both cylinder valves. The indicator on top of the regulator will turn bright green. When the cylinder becomes empty, the indicator will change to bright orange. Now turn the regulator lever to the side of the "reserve" cylinder and the green signal should return. You may now remove the empty cylinder to have it refilled without interrupting the flow from the full bottle. After filling the cylinder, connect the pigtail hose and slowly open the bottle valve.

USING THE PROPANE SYSTEM

After your recreation vehicle is completely set up use the following steps for propane operation:

1. Close ALL burner valves, controls and pilot light valves.
2. Open the main valve in the propane tank slowly to avoid a fast rush of propane vapor through the excess flow valve causing propane "freeze-up." Should you experience propane "freeze-up," close the main valve and wait 15 minutes before trying again.
3. Listen carefully as propane begins to flow. If a hissing noise is heard for more than one or two seconds, close the main valve and contact your recreation vehicle dealer to have the propane system tested.

4. Light the appliances as needed and directed in the appropriate appliance manufacturer's owner manual located in the Warranty Packet.

Keep the propane container valves closed at all times unless you are using the propane gas system or are having the propane container filled.

Make sure **that you read and fully understand ALL safety requirements for handling and operation of the propane system.**

The Warranty Packet contains manufacturer's user guides for the various appliances hooked to your propane system.

The propane system provides added benefits to your camping enjoyment; however, it must be handled with care. If you have any questions or concerns, consult with your dealer and/or the specific manufacturer.

If you have double cylinders on your recreation vehicle, use only one at a time. Otherwise, the propane supply will be drawn equally from both cylinders until the supply has been totally exhausted. Using one cylinder until it is empty, then using the second cylinder will allow you to fill the empty cylinder at your convenience without running totally out of propane.

CALCULATING PROPANE GAS USAGE

It is important to remember that your furnace, refrigerator, water heater and range all may use propane gas to operate. Each has a different BTU rating, and you will need to consider them to determine how long your propane supply will last. Most RV gas appliances are operated intermittently. Propane consumption depends on individual use of appliances and the length of time operated. Unless there is heavy use of hot water, the water heater consumption of propane is minimal. During cool temperature or high wind conditions, furnace consumption can be extremely high.

To calculate your propane supply, take the BTU ratings for your propane appliances and divide that into the BTU availability. Each gallon of propane gas (3.785 liters) produces about 91,500 BTU's (96,528 kilojoules) of heat energy.

Propane consumption chart

The following chart provides average propane consumption information.

Appliance	Average BTU Consumption per Hour	Kilojoules/Hour
Water Heater	8,800	9,280
Refrigerator	1,200 – 1,500	1,270 – 1,580
Furnace	35,000 – 40,000	36,930 – 42,200
Range/oven	7,100	7,490
Range, rear burner	6,500	6,860
Range, front burner	9,000	9,490
Outside Grill	10,000	10,550

COOKING WITH PROPANE GAS

⚠ WARNING

Do not turn gas range burner controls to ON and allow gas to escape before lighting.

⚠ WARNING

Do not use portable fuel burning equipment (i.e., wood and charcoal grills or stoves) inside the recreation vehicle.

Unlike homes, the amount of oxygen supply is limited due to the size of the recreation vehicle. Proper ventilation when using the cooking appliance(s) will help you avoid the danger of asphyxiation.

It is especially important that cooking appliances not be used for comfort heating, as the danger of asphyxiation is greater when the appliance is used for long periods of time. FAILURE TO COMPLY MAY RESULT IN DEATH OR SERIOUS INJURY.

The following warning labels are located in the cooking area to remind the user to provide an adequate supply of fresh air for combustion.

TO ENSURE A SUPPLY OF FRESH AIR TO OCCUPANTS, OPEN VENTILATORS WHEN FUEL BURNING RANGE, FUEL BURNING CARRY-ON APPLIANCE, AND/OR FUEL BURNING LIGHTS ARE IN OPERATION. COOKING APPLIANCES SHOULD NOT BE USED FOR SPACE HEATING PURPOSES.	DE MANIÈRE À ASSURER UNE ALIMENTATION EN AIR FRAIS AUX OCCUPANTS, OUVRIER LES VENTILATEURS LORSQUE LA CUISINIÈRE, LES APPAREILS DE CHAUFFAGE PORTABLES ET/OU LES LAMPES DE COMBUSTION D'HUILE SONT EN FONCTIONNEMENT. LES APPAREILS DE CUISSON NE DOIVENT PAS SERVIR AU CHAUFFAGE DES LOCAUX.
---	---

JA-110

Ensure a supply of fresh air (Canada units only)

⚠ DANGER

Do not use gas cooking appliances for comfort heating. Can lead to carbon monoxide poisoning, which can lead to death or serious injury.

⚠ WARNING

Gas cooking appliances need fresh air for safe operation. Before operating:
Open vents or windows slightly or turn on exhaust fans prior to using cooking appliance. Gas flames consume oxygen, which should be replaced to ensure proper combustion. Improper use can result in death or serious injury.

Cooking / comfort heating label

TRAVELING WITH PROPANE

Use care when fueling your tow vehicle. Make certain your propane container is properly fastened in place.

Some states prohibit propane appliances to be operated during travel, especially in underground tunnels. Make sure you know the laws for the areas where you travel.

The label listed below should be kept permanently affixed to your recreation vehicle:



Re-fueling Warning Label

SECTION 7: FUEL & PROPANE SYSTEM

Notes:

There are two different water systems in your recreation vehicle:

- The fresh water system consists of the fresh water holding tank, fresh water connections, water pump, outside shower assembly (if so equipped), water heater, faucets, tub/shower, and water purification system (if so equipped).
- The waste water system consists of the waste water holding tank, sewage holding tank, drains and toilet.

PLUMBING SYSTEM MAINTENANCE

- Check all fittings, pressure and waste, for leaks before each trip or before vehicle storage as part of your normal maintenance:
- Inspect all faucets, the water purification system (optional) and sink connections (including drain baskets or filters).
- Inspect connections at the water pump and water heater.
- At the end of every trip, you should drain any unused water from the fresh water system. All water contains contaminant and mineral particles that can cause fresh water system odors. Untreated well water is a major source of water system odors.
- The fresh water (or potable water) system needs periodic sanitization and winterization to take care of all the components within the plumbing system and help discourage the growth of bacteria and other organisms that can contaminate the water supply.

Typically, there are labels affixed to the exterior of the recreation vehicle sidewall that indicate the locations of the water system drains and fills. Be aware some drain valves may be located inside the vehicle (once the exterior label is found, go inside to find the drain corresponding location).

MONITOR PANEL (IF SO EQUIPPED)

Depending on your model, the monitor panel may be located on the Command Center panel, on an interior wall, or on the exterior utility center. The monitor panel allows you to monitor the fresh water, grey water, black water and auxiliary battery levels. These functions are controlled using the “tact” switches located on the monitor panel faceplate. The monitor panel operates on 12-volt DC power supplied by either the converter or auxiliary battery. No power is drawn from the battery unless a switch is pushed or turned ON. Fuses for the monitor panel are located in the load center. Refer to the manufacturer’s operators manual for additional information.

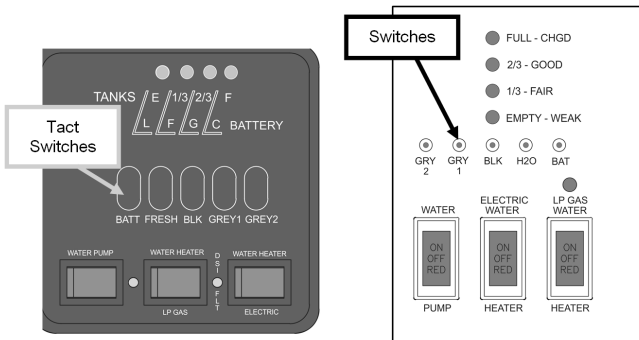

Monitor panel

Command center panel

(Monitor panel appearance and components listed may vary)

SECTION 8: PLUMBING SYSTEM

Operation

Press only one “tact” switch at a time. As you push either the “FRESH”, “BLK” “GREY1” or “GREY2” switch, one or more LED lights will illuminate (from left to right) indicating the content level for that tank. When pushing the “BATT” switch, the LED lights illuminate from left (lowest) to right (highest) to indicate the estimated auxiliary battery condition.



NOTE: When using shore power all 4 LEDs will light. If disconnected from shore power, 3 LEDs will light to indicate a full charge. (The 4th LED may blink)

The LEDs corresponding to the letters C,G,F,L on the panel indicate the following:

C	=	Charge at 12.7 volts
G	=	Good at 12.1 volts
F	=	Fair at 11.6 volts
L	=	Low at 6.0 volts.

Water pump switch (if so equipped)

The red water pump switch is located on the monitor panel, the utility center or both (depending on your model). When the water pump switch is ON, the water pump will run until it reaches 45 lbs. of pressure. It will recycle when pressure drops. The switch will light up when it is turned ON. Turn the switch OFF when the water pump is not being used.

Water heater switches (if so equipped)

These red switches are located on the monitor panel. The “LP GAS” water heater switch (12V) enables propane operation of the water heater. The “ELECTRIC” water heater switch (120V) enables electric operation of the water heater. Normally both switches should be turned on to provide the fastest hot water recovery time. The water heater can be operated in electric only or gas only modes by pressing each switch independently. The switches will light up when turned ON. If the RV contains a tankless water heater, these switches will not be present on the monitor panel.

DSI FLT - Direct Spark Ignition Fault (if so equipped): This light located between the water heater switches will indicate a problem with the LP portion of the water heater. When the LP GAS switch is turned on, the light will blink quickly 3 times and the water heater will ignite. The light will then remain off. If the light comes on and stays on, it indicates the gas side of the water heater has not fired and there is a problem with the igniter.

FRESH WATER SYSTEM

All water contains contaminant and mineral particles that can cause fresh water system odors. Untreated well water is a major source of water system odors. The fresh water (or potable water) system needs periodic sanitization and winterization to take care of all the components within the plumbing system and help discourage the growth of bacteria and other organisms that can contaminate the water supply.



WARNING

DO NOT drink water deemed microbiologically unsafe or of unknown quality..

⚠ WARNING

Never travel with full fresh, black or grey water holding tanks..

FRESH WATER HOLDING TANK

There may be several ways to fill the fresh water tank depending on the model. For details of each method, refer to the *Fresh Water Connections* or the *Utility Center (if so equipped)* sections. There are plastic overflow tubes plumbed into the fresh water holding tank which allow water to flow out of the water tank (see *City Water Fill*). Occasionally, you may see water coming from the overflow tubes when the fresh water holding tank is filled. This is normal and can be a result of the recreation vehicle being parked on an incline, or the motion caused by starting or stopping during travel.

⚠ CAUTION

Indicates a potentially hazardous situation that, if not avoided, may result in minor or moderate injury. It may also be used to alert against unsafe practices.

⚠ CAUTION

Indicates a potentially hazardous situation that, if not avoided, may result in minor or moderate injury. It may also be used to alert against unsafe practices.

12-VOLT WATER PUMP & SWITCH

When you want to use water in your recreation vehicle and it is not hooked up to city water, you will need sufficient 12-volt DC power to run the water pump.

Once activated, the water pump (also known as the demand pump) will self-prime, and provide water. The pump is designed for **intermittent use only**. Using the pump continuously or with high pressure will shorten the life of the pump and is not covered in your warranty. The water pump is engineered with a check valve to prevent water from back flowing into the fresh water supply tank.

Periodically check the in-line water pump strainer for accumulated debris. To clean, shut off the water pump, unscrew the clear cap, remove the re-useable metal strainer and clear any debris, then reinstall.

For additional information on the care and operation of the pump, read the safety and operating information in the pump manufacturer's owner's manual.

Water Pump Switch (if so equipped):

Most water pump switches illuminate when the water pump is activated. In most models, the (red) pump switch is located on the monitor panel or the utility center. When the water pump switch is ON the pump runs until 45 lbs. of pressure has been achieved. The red light will stay on. The water pump automatically recycles when pressure drops. Some cycling may occur depending on the volume of water being released. Turn the water pump switch OFF when it is not in use.

SECTION 8: PLUMBING SYSTEM

NOTE: If there are multiple pump switches; the pump must be turned off from the same switch used to turn it on. (e.g. if the pump is turned on at the utility center, it cannot be turned off with the switch inside the RV at the command center)

NOTE: Depending on the model, the water pump switch will be a black rocker switch located near the sink cabinet.

The water pump switch should be in the OFF position when the RV is left unattended for any amount of time. If something would happen to the water system, this may help limit water damage to a smaller area.

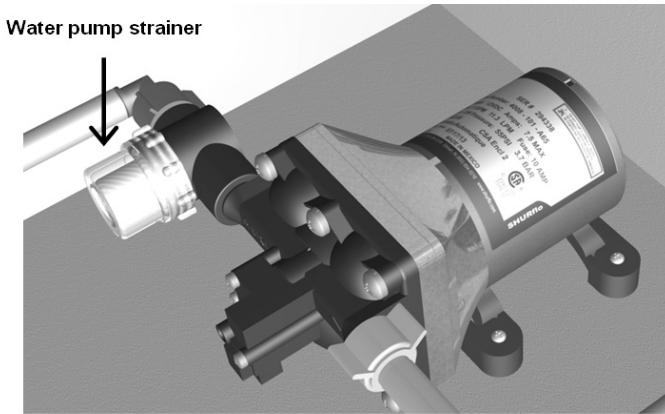

Water Pump

WATER PRESSURE REGULATOR (CUSTOMER SUPPLIED)

Excessive pressure from the water supply source may be encountered in some parks, especially in mountain regions when using the fresh water inlet or black tank flush. Water pressure regulators are available to protect your recreation vehicles plumbing system against such high pressure.

⚠ CAUTION

A water pressure regulator is recommended to prevent damage to the plumbing system or components. To prevent damage when using the city water connection, a 45 lb. (315 KPa) rated water pressure regulator is recommended.

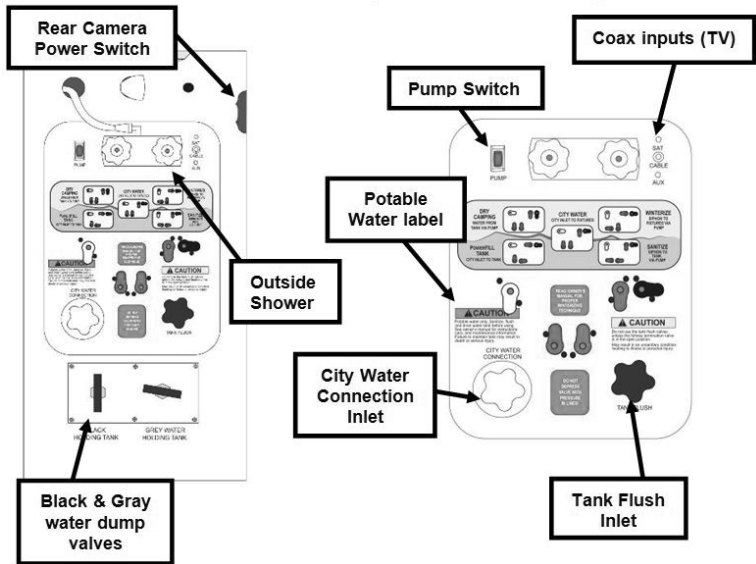
UNI-DOCK UTILITY CENTER (IF SO EQUIPPED)

Uni-Dock Utility Center

The Uni-Dock Utility Center is located in an exterior compartment in your recreation vehicle and allows you to perform the following functions:

1. Power fill the fresh water tank for remote or dry camping
2. Use the pump to supply water to fixtures from the fresh water tank
3. Use the pump to siphon fill or sanitize the fresh water tank from a bucket
4. Connect to city water at the camp site to supply water to RV fixtures
5. Winterize the plumbing lines and fixtures
6. Bypass the hot water heater when winterizing to avoid damage to the water heater
7. Rinse the black tank to help control odors and prevent waste buildup
8. Rinse off items outside the unit with hot/cold faucet
9. Connect up to (3) coax lines with satellite, cable and auxiliary

The city water connection inlet is located in the Uni-Dock utility center. Use a non-toxic drinking water hose dedicated only to supplying the recreation vehicle with fresh water. To reduce the chance of contamination, prevent the non-toxic drinking water hose from coming into contact with the ground. Install the city water connection inlet cap when the fresh water connection is not being used.

The fresh water connection should be disconnected (i.e., the non-toxic drinking hose disconnected) when the recreation vehicle is unattended for any amount of time. If something would happen to the water system, this may help limit water damage to a smaller area.

SECTION 8: PLUMBING SYSTEM

Do not remove the potable water label.

⚠ WARNING

POTABLE WATER ONLY. SANITIZE,
FLUSH AND DRAIN BEFORE USING.
SEE INSTRUCTION MANUAL.
FAILURE TO COMPLY COULD
RESULT IN DEATH OR SERIOUS
INJURY.

AD-04

Potable water only label
(Label appearance may not be exact)

Using the Uni-Doc utility center

⚠ WARNING

A check valve is located inside the City Water Connection inlet on the Utility Center. **NEVER** depress the check valve on “CITY WATER CONNECTION” inlet with pressure in the line. It will cause irreparable damage to the valve function and the inlet will leak water.

The following information details the functions of the utility center water valves as displayed on the valve operation label located on the utility center front panel.

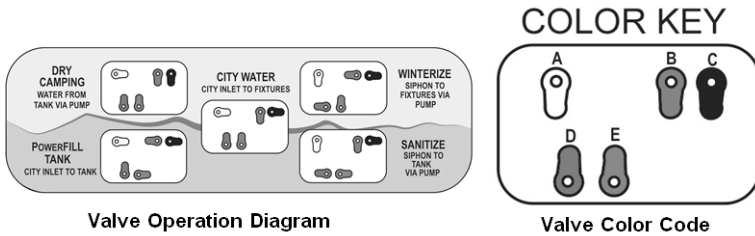

“POWER FILL TANK” (Pressurized fresh water source)

1. Connect the fresh water hose to the City water connection inlet on the utility center.
2. Set the color coded valves to POWER FILL TANK setting:

- (A) White handle pointing right
- (B) Blue handle pointing left
- (C) Black handle pointing right
- (D) Red handle pointing up
- (E) Green handle pointing right



3. Connect the other end of the hose to a pressurized fresh water source (faucet or spigot).
4. Turn the pressurized water source ON, the tank should begin filling.
5. When water has reached the desired level, turn the pressurized water source OFF.
6. Disconnect water source from the spigot/faucet first, then disconnect from the city water fill inlet on the utility center.

“SANITIZE” (or Siphon Fill) the Fresh Water Tank via Pump

NOTE: Refer to the Sanitizing Plumbing System section before starting this process.

1. Connect a garden hose to the city water inlet (do not use your fresh water hose to sanitize the water lines or the tank)
2. Set the colored coded valves to the SANITIZE setting:
 - (A) White handle pointing down
 - (B) Blue handle pointing down
 - (C) Black handle pointing right
 - (D) Red handle pointing left
 - (E) Green handle pointing right
 - The water heater is automatically bypassed on this setting.
3. Place the other end of the hose in a container holding sanitizing solution.
4. Turn the pump switch ON.
5. Fresh water tank should begin drawing solution out of the container. To aid siphoning place the container on a surface approximately (2) feet off the ground.
6. Continue pumping until solution is drawn out of the container, or tank is at the desired level.
7. Turn the pump Switch OFF.
8. Disconnect the garden hose from the city water fill inlet on the utility center.

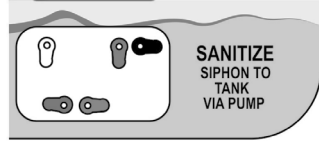

“DRY CAMPING” (pump supplies water from the fresh water tank)

1. Make sure the fresh water tank has an adequate supply of water.
2. Set the color coded valves to the DRY CAMPING setting:
 - (A) White handle pointing right
 - (B) Blue handle pointing down
 - (C) Black handle pointing down
 - (D) Red handle pointing up
 - (E) Green handle pointing up
3. Turn the pump switch ON.
4. Water should be available to all fixtures now.
5. Turn pump OFF when water is not being used.

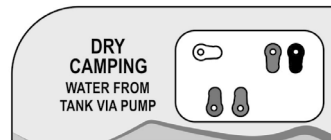

NOTE: To fill the fresh water tank without a pressurized water source, refer to SANITIZE (Siphon Fill) section above, and use a container holding fresh potable water and a hose. Water will be drawn into the tank by the pump. There is no gravity fill inlet on the recreation vehicle.

SECTION 8: PLUMBING SYSTEM

“CITY WATER” (Pressurized fresh water source)

1. Connect the fresh water hose to the city water inlet.
2. Set the color coded valves to the CITY WATER setting:
 - (A) White handle pointing right
 - (B) Blue handle pointing down
 - (C) Black handle pointing right
 - (D) Red handle pointing up
 - (E) Green handle pointing up
3. Connect other end of the hose to the pressurized fresh water source.
4. Turn ON the pressurized water source.
5. Water should now be available to all fixtures.

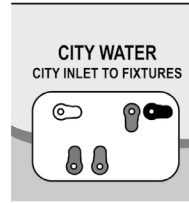

NOTE: To disconnect: Turn off water at the pressurized source first, disconnect hose from the water source, (to release pressure off the system) then disconnect the hose at the City Water Connection on Utility Center last.

“WINTERIZE” (plumbing lines and fixtures via pump)

(Refer to the *Winterizing Plumbing System* section before starting the winterizing process).

1. Connect a garden hose to the city water inlet (do not use your fresh water hose to winterize the water lines)
2. Set the color coded valves to the WINTERIZE setting:
 - (A) White handle pointing down
 - (B) Blue handle pointing left
 - (C) Black handle pointing right
 - (D) Red handle pointing left
 - (E) Green handle pointing up
 - The water heater is bypassed automatically on this setting.
3. Insert the other end of the hose in a container holding RV antifreeze.
4. Turn the pump switch ON.
5. Antifreeze should begin flowing into the plumbing lines and fixtures (the pump will run when a faucet or the toilet is in use). To aid in siphoning place the container on a surface approximately (2) feet off the ground.
6. Open one plumbing fixture, keeping it open until antifreeze appears then close it. Repeat for each plumbing fixture (including the hot & cold lines on the outside shower).
7. Turn the pump OFF when all fixtures have been winterized.
8. Disconnect the hose from the city water connection inlet (it is normal for some antifreeze to exit the inlet hose as it is being disconnected).
9. Leave the valves set on WINTERIZE setting.



WATER PURIFICATION SYSTEM (IF SO EQUIPPED)

Depending on the model, your recreation vehicle may have a canister style water purification system. If the water supply has not been used for some time, allow the water to flow for several minutes to flush the system.

NOTE: Filters should be replaced at the beginning of each camping season or if they have come into contact with contaminated water.

NOTE: When not in use, the water filter cartridge should be stored out of freezing temperatures. RV antifreeze will damage the water filter cartridge.

To Replace Canister Filter Cartridge

1. Turn off water supply using two valves located on the water lines on each side of the canister.
2. Place drip pan below filter housing to catch any spillage.
3. Press the red button on top of the filter housing to release pressure.
4. Using a spanner wrench, rotate the filter housing. Unscrew the housing completely and remove the filter (dispose of the old filter properly).
5. Clean the inside of the filter housing with mild detergent. Thoroughly rinse and wipe clean.
6. Remove the o-ring from the groove in the housing and wipe clean. Recoat with petroleum jelly.
7. Replace the o-ring in the groove, making sure it is properly seated.
8. Install the new filter cartridge.
9. Replace the canister housing (hand tighten is normally sufficient).
10. Turn on the water supply and check for leaks.

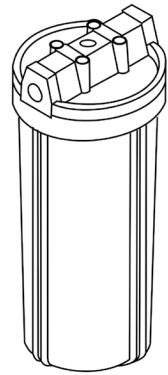

Filter housing

NOTE: There is **no bypass** feature on a canister style water filter. The water filter **must** be removed before sanitizing or winterizing the RV.

SECTION 8: PLUMBING SYSTEM

Each new recreation vehicle is winterized with RV antifreeze before it is shipped to the dealer. To use the water purification system: full system canister water lines need to be flushed of antifreeze and then the filter installed in the canister before use.

Refer to the manufacturer's owner's manual and the label on the water filter cartridge for further information.

CAUTION

- Do not allow the filter housing to freeze.
- Remove the cartridge before using anti-freeze to winterize the system or chlorine solution to sanitize the system.
- Flush housing thoroughly before it is put back into service after winterizing or sanitizing.
- For best results replace cartridge every 6-12 months.
- Do not use carbon cartridges where water is microbiologically unsafe or of unknown quality.
- Maximum operating pressure is 125 psi (8.75 bar).
- Maximum water temperature is 125° F (52° C).

WATER HEATER

WARNING

Hydrogen gas may result if you have not used the water heater for two weeks or more. **HYDROGEN GAS IS EXTREMELY FLAMMABLE.** To reduce the risk of injury under these conditions, open the hot water faucet for several minutes at the kitchen sink before you use any electrical appliance connected to the hot water system. If hydrogen is present, you may hear what sounds like air escaping through the pipe as the water begins to flow. Hydrogen gas may be present even after water has been drained from the water heater tank. Open the faucet at the sink and allow the system to vent for five to ten minutes. Do not smoke or have any open flame near the open faucet while venting. On DSI water heater models, make sure the switch is OFF.

WARNING

Do not replace any component part with an accessory part that is not authorized by the water heater manufacturer, such as an "add-on" electric heating element. Such items are not approved to be installed and could create an unsafe condition, and will void all warranties.

Operating Instructions

 WARNING

If you smell propane gas then STOP! and follow the procedures listed in the Fuel Systems section of this manual before attempting to operate the water heater.

Your motor home may be equipped with either a tank (storage) water heater or tankless water heater. The following is an overview of both systems. For detailed operating instructions, refer to the manufacturer's owner's manual supplied in your Warranty packet.

TANK (STORAGE) WATER HEATER SYSTEM (IF SO EQUIPPED)

Gas/Electric DSI Tank (Storage) Water Heater (If So Equipped)

Your motor home may be equipped with a gas/electric DSI (direct spark ignite) water heater. The following is an overview of the water heater operation. For detailed operating and safety information, refer to the manufacturer's user's guide included in the Owner's Warranty packet.

Read the safety and operating information provided in the manufacturer's user guide before attempting to activate the water heater. Make sure the water heater is filled with water before use; even momentary operation of the water heater without water in it may result in damage to the tank and/or controls. Always open both the hot and cold water faucets when filling the fresh water tank to allow air pockets to be forced out of the water heater.

The DSI water heater is designed to heat water quickly and efficiently. The water heater manufacturer has preset the sensing limit to maintain the water temperature when the water heater is activated. The thermostat on your water heater is not adjustable. It is a temperature sensing limit designed to maintain a water temperature of 130°F (54°C).

The water heater does not have a pilot. It is equipped with an ignition device which automatically lights the burner. Do not try to light the burner by hand.

Operating instructions

1. Turn OFF all electric power to the water heater.
2. Turn OFF the propane supply.
3. Wait five minutes for the propane to clear the area. **If you smell propane STOP!** Follow the safety instructions listed in the manufacturer's owner's manual. If you do not smell propane, go to the next step.
4. Turn ON the propane supply.
5. Turn ON electrical power to the water heater.
6. Turn the switch to the "ON" position. If the burner does not light, the system will automatically attempt two more tries for ignition before lock-out occurs. *NOTE: Each ignition cycle will have a 15 second purge before spark cycle if system is a three try system.*
7. If lock-out occurs before the main burner lights, turn the water heater control switch to OFF, wait five seconds and turn the switch to the ON position. This will restart the ignition cycle.
8. The first start-up of the heater may require several ignition cycles before all the air is purged from the propane lines.

SECTION 8: PLUMBING SYSTEM

If the burner will not come on, the following items should be checked before calling a service person:

1. See if the switch is turned OFF.
2. Check to make sure the propane supply to the water heater is not empty or turned OFF.
3. Check to see if the reset button on the water heater ECO is tripped.

Water heater bypass (If So Equipped)

Your motor home may be equipped with a water heater bypass. This three-valve system is located at either the water heater, or on the utility center panel depending on your model. For detailed information see the *Water Heater Bypass* section

Odor from the hot water system

Many water supplies contain sufficient amounts of sulfur to produce an odor, often called "sulfur water." Sulfur water can be caused by a chemical action or by bacteria. Generally, sulfur water is not harmful, only unpleasant to smell. Refer to the water heater manufacturer's owner's manual for details on eliminating the odor from sulfur water. Odor from sulfur water is not a service problem.

Anode rod protection

⚠ WARNING

Do not replace any component part with an accessory part that is not authorized by the water heater manufacturer, such as an "add-on" electric heating element. Such items are not approved to be installed and could create an unsafe condition and will void all warranties.

The tank in the water heater is protected by a magnesium or aluminum anode to prolong the life of the tank by absorbing the corrosive action of hot water. Under normal use, the anode rod will deteriorate and because of this, the water heater OEM recommends the anode rod be replaced yearly. Water with high levels of iron and/or sulfate will increase the rate of deterioration; therefore, more frequent replacements may be required.

If an anode rod is mostly eaten away, replace it with a new one. The water heater manufacturer recommends replacement of the anode rod when consumption or weight loss is greater than 75 percent.

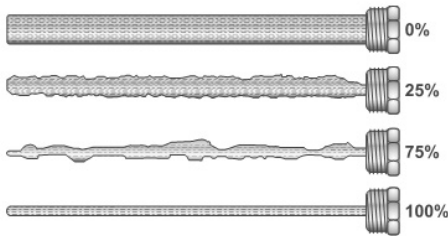

Anode rod replacement chart

Operating the water heater without the proper anode rod protection will decrease tank life and will void the tank manufacturer's warranty on the tank. To extend the anode life, drain the water from the water heater tank whenever the motor home is not being used. Avoid any extended time of non-use with water in the tank.

To prevent a water leak when replacing the anode rod, a pipe thread sealant approved for

potable water (such as Teflon tape) must be applied to the threads of the anode rod. Proper application of a thread sealant will not interfere with the anode's function.

High altitude deration

Operation of the water heater at high altitudes may require derating. If the water heater is not properly derated, lack of sufficient oxygen for combustion may produce improper burner operation. Pilot outage caused by burner lift-off or sooting from a yellow burner may occur, indicating the possibility of carbon monoxide. You may also notice a lack of efficiency in heating the water because of incomplete combustion of the burner at these higher altitudes. Consult with the local propane company, your dealer or the water heater manufacturer for proper derating of the water heater. Change out of the orifice (derating) should be done by the dealer or a qualified service agency.



NOTE: It is important that once the RV has returned to lower elevation (below 4500 feet) any high altitude deration or other adjustments be reversed for proper operation of the water heater.

Pressure & temperature relief valve

WARNING

Do not place a valve between the pressure and temperature (P&T) valve and the tank. Do not remove or plug the relief valve under any circumstances.

The temperature and pressure relief valve is designed to open if the temperature of the water within the heater reaches 120° F, or if the water pressure in the heater reaches 150 pounds. When this pressure is reached, the pressure relief valve will open and water will drip from the valve.

This “weeping” or dripping will continue until the pressure is reduced to below 150 pounds, and the valve closes. This condition is normal and does not indicate a defective relief valve.

One way to reduce the frequency of this occurrence is to maintain an air pocket at the top of the water heater tank. This air pocket will form in the tank by design; however, it will be reduced over time by the everyday use of your water heater. To replenish this air pocket:

1. Turn off the water heater.
2. Turn off the cold water supply line.
3. Open a faucet in the motor home.
4. Pull out the handle of the pressure relief (P&T) valve and allow water to flow from the valve until it stops.
5. Release the handle on the P&T valve - it should snap closed.

Close the faucet and turn on the cold water supply. As the tank fills, the air pocket will develop. Repeat this procedure as often as needed to reduce the frequency of the weeping P&T valve.

Maintenance

Do not allow the burner to burn with a yellow flame, or continue to operate the water heater

SECTION 8: PLUMBING SYSTEM

with an improper burner flame.

Periodically, inspect the water heater vent for soot. Soot is a sign of incomplete combustion and must be corrected before operating the water heater. This is your visual warning that the water heater is operating in an unsafe manner. If soot is present, immediately shut the unit down and contact your dealer or a qualified service agency.

Periodically inspect the vent for obstructions. Do not terminate the vent on your water heater inside of add-on rooms, screen porches or patios. Doing so will result in products of combustion being vented into the rooms or occupied areas.

Draining and winterization:

If the recreation vehicle is to be stored over the winter months, the water heater must be drained to prevent damage from freezing. Damage to the water heater caused by freezing is not warrantable. It is recommended the water heater be drained and bypassed during the winterization process, **particularly if introducing RV antifreeze into the plumbing system. The water heater should never be drained when HOT or UNDER PRESSURE.**

To drain the water heater:

1. Turn off electrical power to the water heater either at the switch from the electrical element or at the breaker.
2. Shut off the propane supply to the water heater.
3. Turn off the water pump.
4. Open both hot and cold water faucets.
5. Remove the anode rod from the tank.

For detailed information see the *Winterizing the Plumbing System* and *Water Heater Bypass* sections of this manual.

TANKLESS WATER HEATER (If So Equipped)

Your motor home may be equipped with a tankless water heater. The tankless water heater uses less LP Gas than storage tank model water heaters since it only uses energy when hot water is demanded. There is no pilot light to burn when no hot water is needed. The tankless water heater supplies an unlimited supply of hot water on demand (once lines are purged of standing water). As hot water is used, the cold water enters the heater. A water flow sensor detects the flowing water and automatically ignites the burner. Water circulates through the heat exchanger and is heated to the set temperature. When the tap is closed, the unit shuts down.

The tankless water heater does not require an anode rod to prevent corrosion, or a by-pass valve for winterizing. It is not affected by high altitudes.

The output temperature of the water depends on the temperature of the inlet water AND the amount of hot water that is drawn. If the inlet water temperature is over 65°F the tankless water heater will generate water in the range of 105°F to 120°F (on Low flame) depending on the water flow selected by the user.

Operating Tips

- Purge air out of ALL hot and cold water lines.
- Open the water heater door and turn the power switch "ON".
- Set GMC (gas modulator dial) to appropriate setting.
 - Normal weather – set dial to the middle area.
 - Extreme cold weather – set dial to the extreme right (large flame).
 - Extreme hot weather – set dial to the extreme left (small flame).

- Open hot water faucet to a medium water flow. It may take a few seconds for the water to travel from the water heater to the faucet.
- To reduce temperature:
 - Turn GMC dial “counter-clockwise”.
 - Increase hot water flow.
 - Gradually add cold water.
- To increase temperature:
 - Turn GMC dial “clockwise”. NOTE: Use caution not to increase the dial too much which could cause the hot water temperature to rise to the point the water heater “limits” and turns OFF the flame (flame shut off is approximately 131° F).
 - Reduce hot water flow.

For Additional Information

For detailed operating information refer to the manufacturer’s owner’s manual included in the Warranty Packet.

Winterization

Freezing of the water heater and its plumbing components will result in severe damage not covered by warranty. For this reason it is advisable to follow the recommendation(s) below if the unit is to be stored in a freezing environment or for long periods of time. At the start of the winter season or before traveling to a location where freezing conditions are likely, the unit must be winterized.

The very small amount of water present in the heat exchanger **DOES NOT** require the installation of a bypass kit. Winterization can be accomplished using one of the two common methods of winterization used for RV water systems, The compressed air method or the anti-freeze method. Refer to “Winterization” in this section for details.

Winter Use Device (WUD)

If you wish to operate the water heater in potentially freezing conditions the model GSWH-1M has a built in thermostat that will start the burner whenever the temperature of the heat exchanger falls below 38°F and will automatically shut off when it senses a temperature in excess of 58 °F.

IMPORTANT: To allow the WUD device to operate you must have sufficient LP Gas in the tank and you must leave the unit powered with the ON / OFF switch in the ON position at all times that freezing may occur. It will not protect the entire RV’s plumbing system. The RV must be designed for winter use/freezing conditions.

Pressure - Temperature Relief Valve

This water heater is equipped with a temperature and pressure relief valve that complies with the standard for Relief Valves and Automatic Gas Shutoff Devices for Hot Water Systems, ANSI Z21.22.

WARNING

SCALDING INJURY-EXPLOSION

- Valve is not serviceable; if defective it must be replaced.
- Tampering with valve will result in scalding injury. Do not place a plug or reducing coupling on outlet part of valve. If you use a discharge line allow complete drainage for both valve and line.
- Tampering with valve will void the warranty.

SECTION 8: PLUMBING SYSTEM

OUTSIDE SHOWER (If So Equipped)

A handheld shower assembly with both hot and cold water may be included for use outside of your recreation vehicle.

1. Be sure the water heater is ON and had sufficient time to heat the water.
2. Open the outside shower compartment door.
3. If dry camping, be sure the 12-volt water pump is ON.
4. Remove the handheld shower from its holder.
5. Turn ON the hot and cold faucet knobs, and adjust the water temperature as desired.
6. To activate the handheld shower turn ON the sprayer head attachment (some models).

To turn off the water, ***always*** close the hot/cold control (faucet) knobs. The lever on the shower head will not completely stop the flow of water; this is intentional to allow for draining. After the water has been allowed to drain from the shower head, return it to the outside shower compartment. Any remaining water in the shower hose will drip or run out; this is not a leak but performs as intended. If you are dry camping, turn the water pump OFF.

Turning off the water with the shower head lever can also create a condition where the hot and cold water will mix through the outside shower faucet, thereby reducing the temperature of the hot water. It can appear as though the hot water heater is not working properly.



NOTE: The shower head may be removed from the hose so that it will drain faster. If you remove the shower head, be sure to reassemble it prior to storage.



NOTE: When putting the shower assembly back into the storage compartment, make sure the hose is not pinched or the shower head is positioned in a way it can be damaged.

FAUCETS

The bathroom, kitchen and outside shower faucets operate much the same way as the faucets in your home. Make sure there is sufficient water available and the 12-volt water pump is turned ON before operating.



NOTE: There may be air in the water plumbing lines which needs to be bled out before a steady stream of water comes from the faucet.

⚠ WARNING

Water temperatures over 125°F (49°C) can cause severe burns instantly or death from scalds; therefore, be careful when using hot water. Always test the water temperature before showering or washing.

BATHROOM TUB / SHOWER

The shower faucet includes a vacuum breaker for the shower. There are two purposes for this breaker:

- To prevent siphoning water through the hose from another fixture.
- To prevent water from being retained in the hose.

The showerhead DOES NOT have a complete shut-off valve (the complete shut-off is at the faucet). The showerhead may drip slightly in the OFF position after use; this is normal and does not indicate a leak or defect.

There may be air in the plumbing lines that will need to be bled out before a steady stream of water comes from the faucet.

The bathing facilities in your recreation vehicle function similar to those in your home. Keep the water heater and holding tank capacities in mind when using the fresh water system. The used water will drain through the plumbing pipes into the grey water holding tank.

1. Be sure the water heater is ON and had sufficient time to heat the water.
2. If dry camping, be sure your 12-volt water pump is ON.

Unlike your home, the recreation vehicle does not contain a water pressure balance valve. If someone is using the shower, it is recommended that the fresh water system **NOT BE USED** until they are finished.

Maintenance

Refer the manufacturer’s user guide or label instructions for detailed cleaning information. The tub/shower walls in your recreation vehicle are made of ABS plastic material. Use a mild detergent soap and warm water to clean. Do not use gritty or abrasive particle soaps or scouring compound to clean ABS plastic. Avoid using “Citrus” or biodegradable cleaners which contain “D-Limonene.” They will damage plastic materials. Contact your dealer for repair or replacement.

⚠ WARNING

Water temperatures over 125°F (49°C) can cause severe burns instantly or death from scalds; therefore, be careful when using hot water. Always test the water temperature before showering or washing.

HARDWARE & SINK OR SHOWER FIXTURES

Use mild dish soap and water to clean these fixtures. Do not use harsh chemicals or sprays. A mild solution of vinegar and water works well to remove hard water spots and stains from the sink or shower fixtures.

SECTION 8: PLUMBING SYSTEM

DRAINING THE FRESH WATER SYSTEM

Permanent water tanks may be drained through a valve located near the tank. A recreation vehicle with a demand pressure pump system will have low-point drains attached to the water lines (normally located near the water tank).

These low-point drains will release water in the supply lines by opening the valves and all faucets. The water heater has its own drain plug. To drain the permanent fresh water holding tank and supply lines:

1. Turn the water heater power OFF (Turn off the Electric & LP GAS switches).
2. Open all faucets, including the outside shower faucet.
3. Open the “fresh tank drain” valve. All permanent fresh water tanks can be drained by one of two types of drain valves. A white plastic drain is attached to the exterior wall (open valve to drain) or a valve located inside the motor home adjacent to the water tank (this knob turns 45° to open or close).
4. Open the “low point drains” by turning, then pulling the handles up. As their name indicates, they will be at the lowest point of water lines. A label is placed on the outside of the RV to indicate where the drains are located. The drains will typically need to be opened from inside the motor home. Once the label is found on the exterior sidewall, go inside the motor home to find the corresponding location of the drains.
5. Drain the sink by removing the drain cap.
6. Turn ON the water pump and allow it to run as needed.
7. If the RV water heater has bypass valves: Set them to the BYPASS configuration. (refer to the *Water Heater Bypass* section). Disregard if there are no bypass valves.
8. Operate the toilet flush lever until water stops flowing.
9. Relieve the water pressure using the P&T valve BEFORE removing the water heater drain plug. If there is any water pressure present the water will spray out of the opening when the drain plug is removed.



Exterior fresh water drain

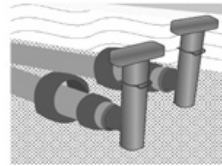

Low point drain

When you are finished draining the fresh water system, reverse these steps and dump the grey and black water holding tanks at an appropriate facility or according to local public codes.

It is normal for some liquid to remain in the fresh water tank after drainage procedure.

SANITIZING THE PLUMBING SYSTEM

When to sanitize:

- When your RV is new.
- At the beginning and end of each season.
- When the water system becomes contaminated or every three months of use.

How to Sanitize

1. Turn water heater power OFF. Both switches: (electric & LP gas). Set the valves to **SANITIZE** as indicated on the utility center label. (Setting these valves bypasses the water heater automatically.)



Refer to Uni-Dock Utility Center for setting details and color key

2. Level the recreation vehicle and drain the fresh water system. (see *Draining the Fresh Water System*).
3. Close the low point drain valves and the fresh water tank drain valve.

Full System Canister water filter (if so equipped): Remove the canister; take the filter out of the canister, then reattach the empty canister.

Bypass the cartridge water filter (if equipped). Use the clear plastic tube (supplied with RV) to bypass the water filter.

4. Prepare a chlorine solution using 1/4 cup of household bleach (sodium hypochlorite solution) to one gallon (3.785 liters) of water in a container. Prepare one gallon of solution for every 15 gallons of tank capacity. This will result in a residual chlorine concentration of 50 ppm in the water system.

If a 100-ppm concentration is required as discussed in step 12, use ½ cup of household bleach with one gallon of water to prepare the chlorine solution. One gallon of the solution should be used for each 15 gallons of tank capacity.



NOTE: Fresh water tank sizes vary by model, please contact your dealer or Customer Service for your specific tank size..

5. Put the sanitizer solution in the fresh water tank; attach a hose to the city water connection inlet. Insert the other end of the hose into a container holding the chlorine solution. **Do not use your non-toxic drinking water hose.** Turn the pump switch ON. The solution will be drawn into the fresh water tank. Turn the pump OFF when solution has been drawn into the tank. To aid in siphoning, set the container on a surface approximately (2) feet off the ground. The drain valves must be turned OFF.
6. Remove the chlorine container and finish filling the fresh water tank with clean (potable) water until the tank is full. Keep the valves set on **SANITIZE**. Leave the hose attached to the city water connection inlet; place other end of hose in a container of fresh water. Turn the pump ON. Fresh water will be siphoned into the tank. Turn pump OFF when tank is full. Disconnect the hose from utility center.
7. After the recommended amount of sanitizing solution is in the tank; the water tank is full; the cartridge water filter (if so equipped) is bypassed or the filter is removed from the full system canister water filter (if so equipped); power to water heater should be OFF (both switches: electric & LP gas). When the fresh water tank is

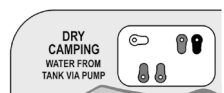

SECTION 8: PLUMBING SYSTEM

full; set the valves to the **DRY CAMPING** setting. Turn the pump ON and sanitized water will flow into the water lines from the tank.

8. Open all hot water faucets one by one until water begins to flow continuously and a chlorine smell is noticeable. Include outside shower faucets (if so equipped). Close hot water faucets.
9. Open all cold water faucets one by one until water begins to flow continuously and you smell chlorine. Include the outside shower faucets (if so equipped). Close cold water faucets.
10. Turn OFF the water pump.
11. Let the solution remain in the tank and lines for at least four hours when disinfecting with 50-PPM residual chlorine. If a shorter time period is desired, then a 100-PPM chlorine concentration should be permitted to sit in the system for at least one hour.



NOTE: To thoroughly sanitize the fresh water tank, the unit should be driven around for a period of time allowing the solution to splash the sides and top of the tank.

12. After the required period, drain the chlorine solution from the fresh water system (see *Draining the Fresh Water System*).

Rinse the system with fresh water:

13. Fill the fresh water tank full of clean (potable) water. Use water from either a pressurized source, or from a container (as detailed below).

a. Filling from a pressurized source: Set the valves to the **POWER FILL TANK** setting. Connect a non-toxic drinking hose to the city water connection inlet. Connect the other end of the hose to the pressurized water source. Turn on the water source. When tank is full, turn off the water source, disconnect the hose from the water source first, then disconnect from the utility panel.



b. Syphon filling from a water container: Set the valves to the **SANITIZE** setting. Insert a hose into the city water connection inlet; place the other end of the hose in a container of water. Turn the pump ON to draw water into the tank. After the tank is full, turn the pump OFF. Remove the hose and the container. To aid in siphoning place the container on a surface approximately (2) feet off the ground. Drain valves must be off.



14. Power to water heater should be OFF (both switches: electric & LP GAS). When the fresh water tank is full, set the valves to the **DRY CAMPING** setting. Turn the pump ON to send water through the lines.



15. Run water through all faucets (hot & cold, including outside shower) until chlorine smell is gone. Turn faucets and outside shower off, turn pump OFF.
16. Then, drain the fresh water system again. (see *Draining the Fresh Water System*). If the RV has the full system canister water filter, remove the canister, reinstall the filter, and reattach the canister.
17. Refill the fresh water tank with fresh water again and when water heater is full of water, turn the water heater power ON. Refer to Step 13 for instructions on refilling the fresh water tank.

Lingering Chlorine Taste:

If a chlorine taste lingers in the water, flush the water system with a solution consisting of one-quart vinegar to five gallons of clean water. Re-flush as necessary. The vinegar solution may damage the water heater or the water filter, so both must be bypassed again before performing this operation.

Follow the steps outlined in *Draining the Fresh Water System* with one exception, do not drain the water heater. Do not remove the water heater drain plug.

For the **full system canister** water filter: remove the canister, take out the filter, then reattach the empty canister.

After draining the system:

1. Water heater power should still be OFF. (both switches: electric & LP Gas)
2. Put the vinegar solution into the fresh water tank; set the valves to the **SANITIZE** setting. Attach a hose to the city water fill inlet. Put the other end of the hose in a container with the vinegar solution. Turn the pump ON. The solution will be drawn into the fresh water tank (the water heater will be bypassed automatically). When the container is empty, turn pump OFF, and disconnect hose from utility panel. To aid in siphoning, place the container approximately (2) feet off the ground. The drain valves must be closed.
3. Fill the fresh water tank full of clean (potable) water. Use water from either a pressurized source, or from a container (as detailed below).



- a. **Filling from a pressurized source;** Set the valves to the **POWER FILL TANK** setting. Connect a non-toxic drinking hose to the city water fill inlet. Connect the other end of the hose to the pressurized water source. Turn on the water source. When tank is full, turn off the water source, **disconnect the hose from the water source first**, then disconnect from the utility panel.



- b. **Syphon filling from a water container;** set the valves to the **SANITIZE** setting. Insert a hose into the city water fill inlet, place other end of the hose in a container of water. Turn pump ON to draw water into the tank. After the tank is full, turn the pump OFF. Remove the hose and the container. To aid in siphoning place the container approximately (2) feet off the ground. The drain valves must be closed.



SECTION 8: PLUMBING SYSTEM

4. Run water through all faucets (hot & cold, including outside shower) until chlorine smell is gone. Set the valves to the **DRY CAMPING** setting. Turn the pump ON to send water through the lines.
5. Close all faucets including outside shower. Turn pump OFF.
6. Drain the system again, but don't drain the water heater. Do not remove water heater drain plug (if so equipped).
7. Close low point drains and fresh water tank drain.
8. Refill the fresh water tank with clean potable water. Use the city water fill connection inlet, and one of the two methods explained in Step 3.
9. Open faucets and check that the chlorine taste is gone.
10. Drain the system one more time (See *Draining Fresh Water System*)
11. Remove the clear tube and replace the cartridge filter (if so equipped), or remove full system canister, insert filter, and reattach canister to the mount.
12. Refill the fresh water system with clean water.
13. After filling the water tank, set the valves to either DRY CAMPING or CITY WATER in order for water to flow through the water heater again.

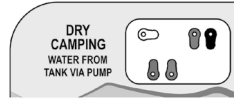

WINTERIZING THE PLUMBING SYSTEM (UNI-DOCK UTILITY CENTER)

NOTE: If your recreation vehicle is equipped with a Frigidaire or Samsung RESIDENTIAL REFRIGERATOR, the air method should be used. RV antifreeze should not be used in the refrigerator. See Winterizing Appliances section or contact your dealer for assistance.

Preparing your RV for colder weather or storage is very important for most states and Canada. Failure to prepare your RV may cause water supply lines and the water heater to freeze.

If you chose to perform the winterization process yourself, please read and understand the following information before starting. Contact customer service or your dealer for questions about this procedure.

NOTE: The winterization process explained in this manual represents the typical application. Your process may vary slightly due to varied plumbing configurations between models.

Refer to the *Uni-Dock Utility System* section for valve settings.

1. Compressed Air Method:

This method uses compressed air to blow out any remaining water in the system after initially draining water using drain valves. Tools required would be an air compressor and a blowout plug.

2. Winterizing with antifreeze:

Requires non-toxic RV antifreeze in the water lines and does not require any special tools. Use **ONLY RV ANTIFREEZE** in your fresh water system for freeze protection. No other product or commodity should be used.



NOTE: The water heater must be drained to prevent damage from freezing. It is recommended the water heater be drained and bypassed during the winterization process particularly if introducing RV antifreeze into the plumbing system. Antifreeze should be kept out of the water heater.

⚠ CAUTION

If the recreation vehicle is going to be stored in a non-temperature controlled environment with a risk of temperatures reaching 32°F (0°C) or lower, the air pressure method alone is not adequate, winterizing with RV antifreeze is the proper method to use.

Air Pressure Method

⚠ WARNING

Never apply air pressure to the water system with any of the valves in the closed position. Air pressure applied to a closed valve, faucet or low point drain could potentially damage the seals and cause water leaks. If you have questions, consult with your RV dealer. Using RV antifreeze is the preferred method of winterization.

⚠ CAUTION

Recommended pressure is 30 PSI, exceeding this pressure may rupture water line couplings and void your warranty.

Exceeding this air pressure may rupture water line couplings / seals and void your warranty.

1. Turn off the water heater gas valve typically located outside the RV. Water heater power should be OFF. (turn off both ELECTRIC and GAS switches at the command center panel)

SECTION 8: PLUMBING SYSTEM

2. Water heater bypass: **NOTE: On the Uni-Doc utility center there are no bypass valves.**
3. Level the RV and drain the fresh water tank, water heater and hot & cold water lines. Open all low point drains and fresh water tank drain. Faucets inside the RV may need to be opened also to relieve pressure and allow lines to drain. Refer to Draining the Fresh Water System section.
4. Remove the drain plug from the water heater as shown (typically located outside the RV). Do not remove the drain plug if the water heater is hot or under pressure. Release pressure & let it cool off.
5. Water filter should be removed for winterizing. Refer to Water Purification System section. Your RV may have one of two types of filters:

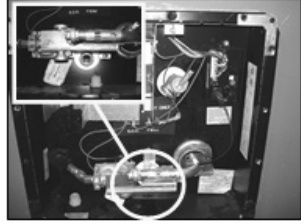

Water heater drain plug

Full System Canister Filter: On full system canister water filters (if so equipped), remove the canister, take out the filter, and reattach the empty canister.

Cartridge Water Filter: Remove the cartridge filter, and replace it with a bypass tube that is typically supplied with your RV.



NOTE: Filters should be replaced at the beginning of the camping season or if they have come into contact with contaminated water or antifreeze.

6. Run the water pump until it is dry (approximately 15 to 20 seconds). Operating the pump longer than that with no water in it can damage the pump.
7. Open all faucets in the RV. If there is an outside shower, attach the shower hose to the shower, and open the shower faucets.
8. Attach a blowout plug to the city water inlet on the utility center panel.
9. Attach the air hose to the blowout plug. Set compressor to 30 PSI. Set the colored valves on the utility center panel to CITY WATER setting. Blow air into the utility center and all water in lines should clear out in 5 or 10 minutes.
10. If your RV has a residential refrigerator, dishwasher, or clothes washer, refer to the section Winterizing Appliances to complete the winterization process.
11. Pour one cup of RV antifreeze in all the drain P-traps. (Sinks & bathtub)

Winterize the Black Tank Flush:

1. Connect the blowout plug to the Black Tank Flush inlet at the utility center panel.
2. Connect the air hose to the blowout plug. Set the compressor to 30 PSI maximum.
3. Make sure the black tank has been emptied. Open the black tank drain valve.
4. Blow air into the flush inlet for 30 to 60 seconds.
5. Disconnect the compressor and blowout plug.
6. Close the black tank drain.

Winterizing with antifreeze:

⚠ WARNING

Automotive antifreeze (ethylene glycol) and windshield washer antifreeze (methanol) are poisonous. Never use these products in your fresh water system. These products are harmful and may be fatal if swallowed.

It may be easier to winterize the RV with another person to assist you.

Antifreeze should **never** enter the water heater, RV water filter, refrigerator, refrigerator water filter, or fresh water tank.

1. Turn water heater power OFF (both switches: electric & LP gas). Water heater should never be drained when HOT or under pressure.
2. Level the RV and drain the fresh water plumbing system. See Draining the Fresh Water System.
3. Replace the water filter cartridge with the clear plastic bypass hose (if so equipped). On full system canister water filters (if so equipped), remove the canister, take out the filter, and reattach the empty canister.
4. Refer to *Winterizing Appliances* section for instructions on winterizing the refrigerator, dishwasher or clothes washer.
5. Water heater should be empty after performing Step 2.
6. Make sure the “fresh water tank drain” and “low point drains” are closed. This would include the refrigerator/washer low point drains (if so equipped).
7. Set the water valves to WINTERIZE setting, connect a hose to the city water fill inlet. Insert the other end of the hose in a container of antifreeze. Turn the pump ON. Antifreeze will be drawn into the water lines and fixtures (pump only runs when a faucet or fixture is open).
8. Turn the water pump ON. Antifreeze will be drawn into the water lines.

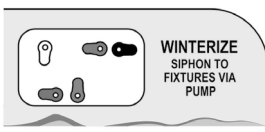

NOTE: When set to WINTERIZE: antifreeze will not enter the water heater or the fresh water tank. There are no dedicated water heater bypass valves.

9. Open the hot water line faucets (kitchen/bath sinks, shower **and outside shower** (if so equipped) until RV antifreeze begins to flow continuously.
10. Close the hot water line faucets and repeat with the cold water line faucets.

Toilet: Flush the toilet several times until you see antifreeze in the bowl.

When you are finished adding RV antifreeze:

SECTION 8: PLUMBING SYSTEM

11. Turn the water pump OFF.

Remove hose & container from the City Water Fill inlet. Put the cap back on the City Water Fill inlet. Leave the valves in **WINTERIZE** position.

12. Pour 1 cup of RV antifreeze into any/all drain P traps (sinks, & bathtub).
13. To prevent staining, wipe the RV antifreeze out of the sinks, shower (or tub), toilet, washing machine tub, & dishwasher tub using a soft, dry cloth.

If needed, contact your RV dealer for assistance.

WINTERIZING APPLIANCES

Winterize Frigidaire Residential Refrigerator:

Blow out water line – do not use antifreeze in this refrigerator.

1. Drain water out of the fresh water tank.
2. Place the water valves in the CITY WATER position at the utility center.
3. Connect a regulated air supply (30 PSI Maximum) to a blowout plug attached to the city water connection at the utility center. Blow out the water lines.
WARNING: RECOMMENDED AIR PRESSURE IS 30 PSI MAXIMUM.

While still blowing air into the water lines:

4. Open the kitchen water faucet and drain water out of the hot and cold water lines.
5. Open the bathroom faucet and drain water out of the hot and cold water lines.
6. Repeat step #4 again verifying that all water has been purged from the cold water lines.
7. Activate the water dispenser on the refrigerator and purge all water from the refrigerator water line until only air comes out of the dispenser.
8. Remove the refrigerator water filter and extract water out of the filter using a swift “wrist flick” motion. (like flicking water out of a paintbrush)
9. Re-install the water filter and activate the water dispenser again verifying that all water has been purged from the filter and the dispenser.

Use a timepiece for the following steps:

10. Remove the ice cube bin, and the ice cream shelf and depress and hold the icemaker manual momentary override switch to the ON (-) position for 15 seconds.
11. After releasing the override switch, wait 2 minutes and 30 seconds and verify that water blows out of the icemaker water fill port. This purge process only lasts a few seconds and begins precisely 2:30 after releasing the switch.
12. Wait a minimum of 15 seconds after the purge process is complete and repeat step #11 one more time to verify that all fluid is purged from the icemaker.
13. Turn the icemaker power to the OFF position.
14. Remove all ice cubes from the ice cube bin and dispenser.
15. Remove all water from the icemaker tray.
16. Dry off the icemaker and freezer cavity to prevent mold formation.
17. Turn water supply line to the refrigerator OFF before attempting to install antifreeze in the RV water lines.
18. Prop open the doors of the refrigerator to prevent mold formation or odors.

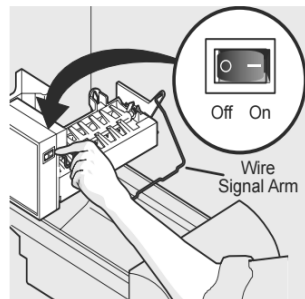

De-winterize the Frigidaire Residential Refrigerator:

When preparing the camper for use again in the spring:

Purge all antifreeze out of the water lines of the RV then:

1. Turn ON the water supply valve to the refrigerator.
2. Replace the refrigerator water filter.
3. Fill the fresh water tank, or attach pressurized water to the utility center panel.
4. Turn on water to the RV either with the pump or pressurized water.
5. Turn refrigerator power ON.
6. Run the water dispenser on the refrigerator until water runs steadily from it.
7. Remove the ice cube bin, hold the icemaker power switch in the ON position for 15 seconds. In 2 minutes and 30 seconds water should come out of the icemaker fill port.
8. Run a batch of ice cubes to make sure the icemaker is working properly.

Winterize the Samsung Residential Refrigerator:

Blow out water line – do not use antifreeze in this refrigerator.

1. Remove the refrigerator water filter and discard it. Replace it at the beginning of the next camping season.
2. Open the refrigerator water supply valve (typically in the kitchen island)
3. Operate the water dispenser on the refrigerator and hold a cup under the dispenser to catch the water. Operate the dispenser until only air is coming out.
4. Open the freezer and remove the ice cube bin by pressing the lever (top photo) at the side of the icemaker and pulling the tray out. Discard any ice or water in the bin.
5. Find the Test Switch on the icemaker (photo at right). Press and hold this button for 8 seconds to initiate a test cycle which will take about 5 minutes to run.
6. As the test cycle runs, the air should blow any water out of the icemaker. When the test cycle is done, the icemaker is reset. Turn power OFF to the refrigerator.
7. Replace the ice cube bin
8. Turn OFF the water supply valve at the kitchen island.
9. Prop open the doors to prevent odors and mildew.

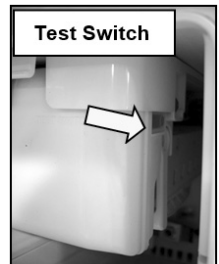
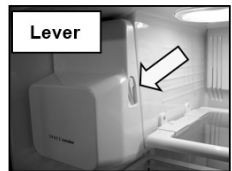

De-winterizing the Samsung Residential Refrigerator:

When preparing the camper for use again in the spring, **purge all antifreeze out of the water lines of the RV then:**

1. Turn the water supply valve ON at the kitchen island.
2. Replace the refrigerator water filter.
3. Fill the fresh water tank, or attach pressurized water to the utility center panel.
4. Turn on water to the RV either with the pump or pressurized water.
5. Turn refrigerator power ON.
6. Run the water dispenser on the refrigerator until water runs steadily from it.
7. Icemaker should be ready to make ice after winterizing was completed. If it does not make ice, press and hold the Test Switch for 8 seconds, test cycle begins and runs for 5 minutes, and then the icemaker should work properly.

IMPORTANT: Do not reset the icemaker more than one time in a 24 hour period. This can cause the icemaker tray to overflow and cause ice to form in the ice bucket

SECTION 8: PLUMBING SYSTEM

Winterize RV style refrigerator:

If your recreation vehicle has an RV style refrigerator; unplug the appliance, turn off the gas and 12V power, and prop open the doors to prevent odors from forming. If it includes an ice maker, the water line should be disconnected from the water solenoid and drained. Contact your dealer for assistance.

Winterize Whirlpool Clothes Washer (If So Equipped):

1. Set the water temperature to WARM, Set the selector knob to NORMAL and press START. As air is being blown into the water lines, air will eventually replace the water coming into the drum. Press and hold CANCEL/DRAIN, move the selector to DRAIN/SPIN and run the washing machine briefly which should drain water out of the drum.
2. As antifreeze is added to the water lines in the RV, set the temperature to WARM, and Set the selector knob to NORMAL and press START. This will bring antifreeze in through the hot and cold water lines. **Run the washer just long enough to bring about a quart of antifreeze into the drum.**
3. Press CANCEL/DRAIN. If you open the drawer for the softener (as shown) antifreeze will be present in the drawer.
4. Turn the selector to DRAIN/SPIN. This should drain antifreeze down into the pump. Stop the washer and unplug it. Wipe out any excess antifreeze in the drum.



De-winterizing the Whirlpool Clothes Washer:

Run a full empty wash cycle before camping season begins.

Winterize Fisher Paycal Dishwasher (If So Equipped):

1. Open the dishwasher and select RINSE. Close it and turn it ON. Antifreeze should be brought in through the water lines. Let it run through the rinse cycle which should take approximately 3 minutes.
2. The dishwasher will drain the antifreeze into the pump

Winterize the DEHCO Dishwasher (If So Equipped):

1. Open the dishwasher and select RINSE. Close it and turn it ON. Antifreeze should be brought in through the water lines. Let it run through the rinse cycle which should take approximately 3 minutes
2. The dishwasher will drain the antifreeze into the pump.

De-winterizing the Dishwasher: Run an empty wash cycle before camping season begins.

Winterize a macerator toilet: (If So Equipped):

1. Press the NORMAL flush button (arrow) one time. This will bring antifreeze into the bowl.
2. Make sure there are a couple cups of antifreeze in the toilet bowl. Add a little if necessary.
3. Press BOTH flush buttons together and release. This empties the bowl and puts antifreeze into the the flush valve and leaves the valve open.

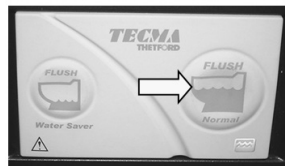

De-winterize the macerator toilet:

After antifreeze has been purged from water lines, press either flush button until clean water appears in the bowl.

BLACK/GREY WATER SYSTEM

Water from the sinks and shower flows into the gray water (or waste water) holding tank. Water from the toilet will flow into the sewage (or black water) holding tank.

 WARNING

Never travel with full black or grey water holding tanks. This not only wastes your fuel but depending on the location of the tank(s), it can affect your tow vehicle handling characteristics.

The weight of the holding tank contents is not calculated into the RV cargo carrying capacity (this extra weight would reduce your available cargo capacity). Traveling with full holding tank(s) could possibly cause you to exceed the individual tire ratings and/or the RV GAWR or RV GVWR. Potential damage to suspension components, such as springs, tires and axles, could result.

If your RV holding tank(s) are located behind the axles, the weight of the full tank(s) will reduce the hitch weight. Trailer sway and other handling difficulties can be the result of the hitch weight being too light.

Dump the gray and black water holding tanks before traveling to avoid carrying unnecessary weight. If you are dry camping and cannot immediately empty your holding tanks, reduce your vehicle speed until you reach a dumping station.

Before using the RV or after dumping the grey and black water holding tanks, always add the proper amount of deodorant to the black water tank to prevent malodors and help break down holding tank contents (unless winterizing). Follow the deodorant bottle or package instructions. Driving to a disposal site will normally loosen any accumulated waste debris or solids from the sides of the holding tanks.

 WARNING

Do not add automotive antifreeze or caustic chemicals such as laundry detergents into the holding tanks. Although these products may have a deodorizing effect, they may damage the plastic and rubber parts of the plumbing system or the components.

Drain pipes With P-Trap (If So Equipped):

The drain pipes may be equipped with a “P-trap” installed to help prevent odors from escaping into the RV. During travel, water from the P-traps may spill and permit odors into the RV. By adding water and using a RV approved deodorizing agent you will dissolve the contents faster and will keep the drain lines and tanks clean and free flowing. These chemicals are available at an RV supply store or your dealer.

Drain pipes With Dry Sealing Valve (If So Equipped):

Your RV may be equipped with a dry sealing valve that prevents the escape of odors from your waste system and eliminates the need for P-traps. Should the RV drain piping system become clogged and a mechanical cleanout tool is used to open the drain pipe, it is important that the dry valve be removed before passing the cleanout tool through the piping. Passing a

SECTION 8: PLUMBING SYSTEM

mechanical cleanout tool through the waterless valve may cause damage to the internal seal that may potentially allow sewer gases to escape into the RV interior. A label has been placed near the location of the waste valve that reads as follows:

**REMOVE WATERLESS TRAP BEFORE
USING MECHANICAL DRAIN – CLEANING DEVICES**

Vents:

Another important part of this system is the vent pipes and vents that release air from the grey and black water holding tanks. On most models the exterior vent cap is attached to the roof and must be kept clear of obstructions to perform as intended. On some models, the vent pipe may be part of the drainage system referred to as a “wet vent” (water flows downward as air flows upward in the same pipe).

Some models are equipped with a side vent system. On these models the following label will be next to the termination valve. This label should not be removed from your recreation vehicle.

CAUTION

Keep drain valve closed to minimize the presence of sewer gases.
Sewer gases may be present when RV is connected to campground sewage hookup.
May lead to illness or personal injury.

Sewer Hose Storage:

Depending on your RV model, the sewer drain hose may be stored in an exterior compartment marked “Sewer Hose” or it may be located in the hollow square tube bumper. The bumper has removable plastic end caps, and the hose slides inside the hollow bumper.

BLACK/GREY WATER HOLDING TANKS

When connected to the sewer drain line at a campground, keep the “black tank drain” valve closed until the holding tank is at least $\frac{3}{4}$ full. This should provide sufficient water to assist in complete draining of the black water holding tank. Repeat as needed. Never leave the black tank drain in the open position continuously when connected to the campground sewer system. Traveling with the tanks full can affect your fuel consumption, and depending on the location of the tanks, can affect your vehicle handling characteristics. If you are dry camping and cannot immediately empty your holding tanks, reduce your vehicle speed until you reach a dumping station.

WARNING

Whenever possible, do not travel with waste in the holding tanks. Liquid or debris in the holding tank(s) may affect the towing characteristics and may result in property damage or personal injury.

BLACK & GREY TANK DRAINS

There are labels on the exterior of the recreation vehicle indicating the location of the grey tank drain and black tank drain (also called dump valves). Always drain the black water holding tank first so the following grey tank waste water can help rinse any solids or debris from the dump outlet and sewer hose.

1. To make drainage easier, level the RV.
2. Remove the sewer hose housing dust cap, and attach the sewer hose (customer supplied).
3. Place the end of the sewer hose into the approved dump station.
4. Open the black tank dump valve (depending on your model the valve may be located under the RV, or on the utility center). Close the dump valve when the black water holding tank is empty.
5. Open the grey tank dump valve (depending on your model the valve will be located under the RV or on the utility center). Close the dump valve when the grey holding tank is emptied.
6. Remove, clean and store the sewer hose.
7. Close the sewer hose housing dust cap.



Black/Grey tank drain & valves

You can locate many dump stations throughout the United States and Canada in Woodall's, Rand McNally Camp Guide, Good Sam Camp Guide, KOA Kampgrounds Camp Guide and various other publications. Some fuel stations also have dump stations.

Please contact your RV dealer for assistance in the purchase and installation of a sewer hose or sewer hose extension (if needed).

Sewage (black) tank preparation:

⚠ WARNING

It is important to add enough water to prevent solid waste buildup. Follow the directions listed below and in the manufacturer's operator manual.

1. Release one to two quarts (1 or 2 liters) of water into the toilet bowl.
2. Follow the directions on your (RV approved) toilet chemical bottle (customer supplied), by placing the recommended quantity of holding tank chemical into the toilet bowl.
3. Flush the toilet and allow at least two gallons (8 liters) of water to flow into the holding tank.

Waste (grey) holding tank preparation:

No special preparation is required, however, placing a small quantity of chemicals into this tank, such as baking soda or an approved RV chemical, will reduce odors from food particles in the system.

Cleaning & Maintenance:

The toilet should be cleaned regularly for maximum sanitation and operational efficiency. Use only RV approved chemicals. Do not use chlorine (undiluted) or caustic chemicals, such as laundry bleach or drain opening types, in the toilet system. These products damage the seals in toilets and dump valves.

MACERATOR PUMP SYSTEM (IF SO EQUIPPED)

Your RV may be equipped with a macerator pump system used to discharge waste from the gray and black waste tank. The system has a 1-1/2 inch diameter flexible hose that runs from the pump (under the trailer) and is stored in an exterior storage compartment. The system when powered on can discharge waste (uphill if necessary) up to a distance of 150 feet.

⚠ WARNING

Before operating the macerator pump, make sure the external dump hose is properly attached at the RV and at the dump station. The hose is under pressure and therefore waste is discharged under pressure. **Failure to follow instructions can lead to possible injury or property damage. The use of this system for anything other than intended will void the warranty.**

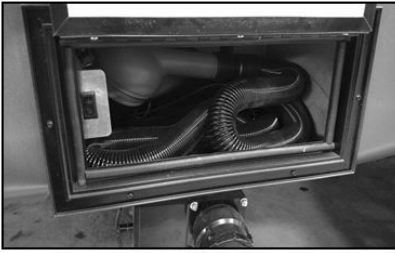

Macerator hose and dump connector



Garden hose connection

Open the hose compartment and pull out the 1-1/2 inch flexible hose (which can extend to 21 feet) with the attached dump connector. The dump connector includes two connections: a small removable cap for attaching a 3/4 inch garden hose, or a larger 3 inch removable cap which allows it to be attached to the sewer outlet at the dump station.

Using the system:

1. To make drainage easier, level the trailer.
2. Attach the dump connector to the 3 inch sewer outlet at the dump station, or to a 3/4 inch garden hose and run the hose to a dumping location.
3. Open the black tank dump valve.
4. Turn the Macerator power switch ON at the hose storage compartment and the macerator pump will begin sending waste through the dump hose.
5. When the tank is empty, turn the macerator power switch OFF. Close the black tank drain valve.
6. Select the gray drain valve.
7. Turn the Macerator Power Switch ON.
8. When tank is empty, turn the macerator power switch OFF. Close the gray tank drain valve.
9. Unhook the dump connector, rinse it out and replace the hose and connector back into the storage compartment.
10. The black tank flush inlet can be used with this system also (refer to *the Black Tank Flush section*).

Macerator Bypass Valve:

A macerator bypass valve is located underneath the external hose storage box. This bypass will allow you to gravity dump the waste from the tanks straight down to a 3 inch sewer hose connection under the trailer, in the event there is a problem with the macerator motor.

To operate:

1. Attach a 3 inch sewer hose to the main dump valve under the trailer and to a sewer outlet at a dump station.
2. Open the desired black / gray (manual) drain valves, one at a time (black then gray).
3. The macerator bypass valve will be pointing away from you and is attached to the macerator pump. The valve access is by design to prevent accidentally turning it off if the system is running normally.
4. The bypass valve is normally open (the handle will be pulled **OUT**). To bypass the macerator, push the bypass valve **IN** (which turns off flow from the macerator pump) allowing waste to flow out of the dump valve under the trailer via gravity.
5. When finished, close the main dump valve under the trailer, along with the black / gray dump valves, and disconnect the sewer hose from the main dump valve and at the dump station.

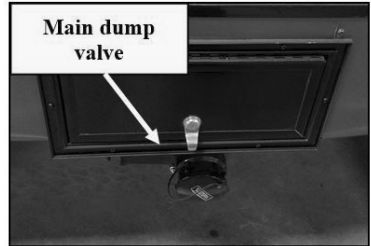
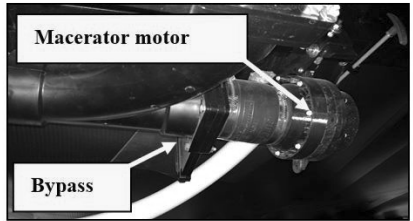

The black tank flush may be used through the gravity dump (by pass valve must be closed).

BLACK TANK FLUSH (RINSING THE WASTE TANK)

The tank flush inlet (also known as the **no fuss flush**), is the black inlet located on the utility center panel. This inlet is provided to assist in flushing out the black water tank. **The drain valve for the black water tank must be OPEN to use this feature.**

When a water hose is connected and the water source is turned on it sprays water into the black water tank. This allows you to rinse the black water holding tank by removing debris and preventing accumulation. There is a check valve incorporated in the plumbing lines to prevent back flow.

NOTE: The colored valve positions do not affect the Tank Flush function. It does not matter where they are positioned when operating the Tank Flush. Refer to the Uni-Dock Utility Center

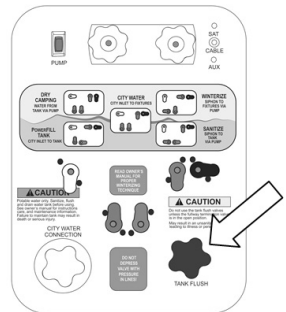

Sewer Tank Flush Inlet on Utility Center

Sewer Tank Flush Inlet procedure:

1. Connect the flexible sewer hose to the 4 inch dump outlet under the recreation vehicle.

SECTION 8: PLUMBING SYSTEM

2. Open the black water dump valve on the utility center and leave it open. Allow the tank to drain.
3. Attach a water hose to the tank flush inlet. Do not use your fresh water hose for this.
4. Attach the other end of the hose to a pressurized water source (40 PSI minimum).
5. Turn the pressurized water source ON. Flush the tank until water appears clear in the 4 inch sewer hose (dump valve must remain open).
6. Turn the water source OFF. Disconnect the hose from the water source, and from the tank flush inlet at the utility center.
7. Disconnect the sewer hose, and close the black water dump valve.



NOTE: To keep debris from clogging the tank sprayer orifices, use the tank flush every time the waste tank is emptied..



CAUTION

The black tank drain valve must be OPEN any time there is a hose (water supply) connected to the black tank flush.



CAUTION

Do not leave any hose (water supply) connected to the black tank flush when it is not in use.



WARNING

Do not use the same hose to fill your fresh (potable) water tank that is used for the black tank flush.

TANK HEATERS (If So Equipped)

Your recreation vehicle may be equipped with heaters for the fresh, gray, black water tanks and the water lines or drain lines. The larger tank heaters are 120VAC and attach directly to the tanks. Water line or drain line heaters are smaller and operate on +12VDC and will be attached to the water lines or drain lines. These heaters will prevent water in the tanks and lines from freezing down to -11°F (-24°C) (contingent on recreation vehicle setup).

The tank heaters are thermostat controlled and will cycle on and off while they are operating. The +12VDC heaters stay on constantly. The thermostat controlled tank heaters turn ON at 44°F (7°C) and will turn OFF at 64°F (18°C). All of the heaters are controlled by a single ON/OFF switch.

Typically this red tank heater ON/OFF switch is located on the command center panel or in the bathroom. The switch lights up red when it is turned ON and controls the heater circuit.

IMPORTANT: In order for the 120VAC tank heaters to be in operation, the recreation vehicle **MUST** be hooked up to shore power or under generator power. If the recreation vehicle is not operating on shore power or generator power, only the +12VDC heaters will operate. This can result in the tanks freezing. The red light on the command center tank switch does not necessarily indicate that **ALL** heaters are operating; it is a warning that the heater circuit is **ON**.

The tank heater switch should be turned ON:

- When liquid is present in the holding tanks and the outside temperature approaches and maintains freezing conditions 35°F (2°C) or colder.

The tank heater switch should be turned OFF:

- When there is **NO** liquid present (tanks are empty).
- When dumping the black and gray holding tanks and the drain pipes.
- When fresh water tank and supply lines are empty or being drained for storage.
- When the recreation vehicle is connected to city sewer and the gate valves are open.
NOTE: Free draining is never recommended, especially in cold weather use.
- When ambient temperatures rise and remain above freezing.

No maintenance on the heaters is required, only a periodic inspection for loose wires, damage, etc. For additional detailed information, refer to the tank heater manufacturer's user guide.

TOILET

The toilet is efficient and easy to operate. Generally, more water is required only when flushing solids. Prior to using the sanitation system, it is strongly recommended to flush the toilet several times to release sufficient water into the holding tank. If there is not a sufficient amount of water used during flushing, the waste materials may not evacuate properly from the drain line to the tank. Clogged tanks and pipes could eventually occur.

The toilet system will perform better when water is run for ten to fifteen seconds after flushing to ensure that the waste will proceed to the bottom of the tank.

Unlike a toilet in a home, which may use up to seven gallons of water per flush, the average recreation vehicle system uses one to three quarts (1 - 3 liters). For added convenience and better sanitation system performance, it is advisable to always have four to six inches (10 - 15 cm) of water in the toilet.

WARNING

It is important to prevent solid waste buildup. Follow the toilet manufacturer's recommended instructions each time after emptying the black water holding tank.

CAUTION

To prevent help toilet blockage, always use RV grade single-ply toilet paper. Do not flush paper towels, diapers, sanitary napkins or other foreign objects down the doilet.

SECTION 8: PLUMBING SYSTEM

It is important to add enough water to prevent solid waste buildup. The following guidelines will help to prevent solid waste buildup.

Sewage (black) tank preparation

1. Release one to two quarts (1 or 2 liters) of water into the toilet bowl.
2. Follow the directions on your (approved RV) toilet chemical bottle (customer supplied), by placing the recommended quantity of holding tank chemical into the toilet bowl.
3. Flush the toilet and allow at least two gallons (8 liters) of water to flow into the holding tank.

Waste (grey) holding tank preparation

No special preparation is required; however, placing a small quantity of chemicals into this tank (such as baking soda or an approved RV chemical) will reduce odors from food particles in the system.

Cleaning & Maintenance

The toilet should be cleaned regularly for maximum sanitation and operational efficiency.



CAUTION

Do not use chlorine (undiluted) or caustic chemicals, such as laundry bleach or drain opening types, in the toilet system. These products damage the seals in toilets and dump valves.

For detailed information refer to the manufacturer's operator manual.

AIR CONDITIONER

Roof Mount (If So Equipped)

The roof mounted air conditioning system is controlled by a thermostat. Cooled air enters the RV through the adjustable “chill grill.” Make sure you have sufficient power available before operating the air conditioner. Do not operate the air conditioner without the return air filter. Operating the system without the filter allows the lint and dirt that is normally stopped by the filter to accumulate on the cooling coil of the air conditioner. This also will lead to a loss of air volume, possible equipment damage and an expensive cleaning process.

A special foam gasket is placed between the roof material and the subframe of the air conditioner to guard against water leakage. The air conditioner is subjected to wind pressures along with motor vibration during normal operation. Inspect the mounting bolts for tightness to ensure there is no leakage or looseness at least annually. Re-tighten bolts when they are loose. **DO NOT** over tighten these bolts as it may damage this gasket. The air conditioner gasket is a wearable part that eventually will need to be replaced. To gain access to the bolts, remove the filtered panel cover on central air systems or the entire air box on non-central air conditioners. Consult the manufacturer’s operators manual or your RV dealer for more information.

For additional information refer to the manufacturer’s owner’s manual included in your warranty packet.

Wall Mount (If So Equipped)

The wall mounted air conditioning system is controlled by a thermostat. Cooled air enters the RV through the grill. Make sure you have sufficient power available before operating the air conditioner. Do not operate the air conditioner without the return air filter. Operating the system without the filter allows the lint and dirt that is normally stopped by the filter to accumulate on the cooling coil of the air conditioner. This will lead to a loss of air volume, along with possible machine failure. Keep the air inlet grill and cabinet clean by wiping with a cloth dampened with warm water and a mild detergent.

For additional information refer to the manufacturer’s owner’s manual included in your warranty packet.

POWER ROOF VENT (IF SO EQUIPPED)

The 12-volt DC attic fan (or powered roof vent) allows fresh air to circulate through the recreation vehicle. Do not leave the attic fan open when the recreation vehicle is stored or unattended for long periods.

High winds, other unusual conditions or obstructions may prevent the dome from closing; the resulting leakage could cause non-warrantable damage.

To use your fan most effectively, close all vents and slightly open a window on a shaded side of your recreation vehicle. You are directing the air flow by opening a window. You will receive the greatest airflow comfort by positioning yourself between the window and the fan.

For additional information refer to the manufacturer’s owner’s manual included in your warranty packet.

Control pad (if so equipped)

The attic fan may be controlled by a control pad. The dome can

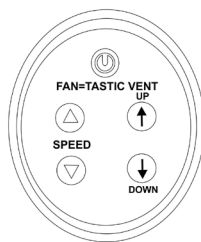

Attic Fan Control

SECTION 9: HEATING & COOLING

be raised or lowered with the UP/DOWN buttons, and the speed of the fan is controlled by the ARROW buttons. It is also equipped with a rain sensor that will close the vent automatically when it rains. The rain sensor can be turned on/off by holding the DOWN button for 3 seconds.

CEILING FAN (If So Equipped)

WARNING

Be careful to avoid placing any object in the path of the ceiling fan blades!

Ceiling fans are both functional and decorative. Turn the ceiling fan ON/OFF using an interior wall switch. The 3-speed ceiling fan is controlled by the pull chain switch. The sequence of operation for the pull chain switch is: OFF, High, Medium, Low, OFF. The slide switch (located on the fan) controls the direction of operation (down for forward, up for reverse). Stop the fan first before reversing the operation direction!



NOTE: During cooler temperatures, set your fan settings to “low,” and set the fan to turn clockwise to pull warm air from the ceiling back towards the floor. In the summer, the fan should turn counter-clockwise to keep air moving.

For additional information refer to the manufacturer’s owner’s manual.

DUCTING & RETURN AIR

All heat discharges, registers and return air grills must be free and clear of obstructions. This includes all closeable registers that are intended to reduce airflow, do not shut it off completely.

FURNACE

The furnace installed in your recreation vehicle is controlled by a 12-volt DC thermostat. Depending on your model, there may be up to two thermostats in your recreation vehicle to enabling you to control the temperature to your comfort level.

The furnace requires both 12-volt power and propane gas for full operation. Make sure you have sufficient power available before operating your furnace.

If you have any questions contact your dealer or Customer Service. A qualified RV technician should perform all furnace maintenance at least once a year (more often depending on furnace usage). Never attempt to repair the furnace yourself.

 WARNING

The furnace should be inspected periodically (monthly during the heating season) for presence of soot on the vent. Soot is formed whenever combustion is incomplete. This is a visual warning that the furnace is operating in an unsafe manner. If soot is observed on the vent, immediately shut the furnace OFF and contact a qualified service agency. Operating the furnace under this condition could lead to serious property damage, personal injury or loss of life.

 WARNING

To ensure your personal safety, do not obstruct or alter the furnace in any manner. Do not install screens over the vent for any reason. Screens will become restricted and cause unsafe furnace operation. For your safety, only the manufacturer's factory authorized parts should be used on your furnace.

FIREPLACE (If So Equipped)

You may have a fireplace installed in your recreation vehicle. For operating details, refer to the manufacturer's owner's manual. If you have further questions, please contact your dealer or Customer Service.

SECTION 9: HEATING & COOLING

Notes:

MICROWAVE



NOTE: To prevent damage, remove the turntable from the microwave when traveling.



NOTE: Make sure you are connected to a 120-volt power source.

⚠ WARNING

Never use the microwave cavity for storage. The microwave cavity should always be empty when not in use.

Microwave Oven Use

For list of preset programs, see the Quick Reference Guide provided with your model.

General Cleaning

IMPORTANT: Before cleaning, make sure all controls are off and the microwave oven is cool. Always follow label instructions on cleaning products.

To avoid damage to the microwave oven caused by arcing due to soil buildup keep cavity, microwave inlet cover, cooking rack supports, and area where the door touches the frame clean.

Clean with mild soap, water and a soft cloth or sponge, or as indicated below.

- Grease filters: mild soap and water or dishwasher.
- Door and exterior: mild soap and water, or glass cleaner applied to paper towel.
- Control panel: sponge or soft cloth and water.
- Stainless steel (on some models): mild soap and water, then rinse with clean water and dry with soft cloth, or use stainless steel cleaner.
- Turntable: mild soap and water or dishwasher.
- Rack(s): mild soap, water and washcloth. Dishwasher cleaning is not recommended.

Convection Microwave (if so equipped)

For details on operation, cleaning and safety information, refer to the manufacturer's user guide included in the Warranty Packet, or visit the manufacturer's website.

The convection microwave bridges the gap between microwaving your food and conventional cooking. **Make sure there is sufficient 120-volt power available before operating the convection microwave** (refer to *Sec. 6 Electrical Systems, Calculating electrical load*).

COOKTOPS (IF SO EQUIPPED)

For detailed operating and safety information, refer to the manufacturer's user guide included in the Warranty Packet.

SECTION 10: APPLIANCES

WARNING

During and after use, do not touch or let clothing or other flammable material come in contact with the top burners (or heating elements), burner grates or other areas near the top burners or oven until they have had sufficient time to cool. These areas can get hot enough to cause burns.

WARNING

Never leave cooking food unattended. Turn the pan handles inward, but not over the tops of the other range burners. Ensure that pans used are large enough to contain the food and avoid boil-overs. Heavy splattering or spills left on the cook top can ignite and cause burns.

WARNING

If using glass, glass/ceramic, ceramic, earthenware or other glazed utensils (or cookware) verify it is safe for use on the top burners. Only certain types of utensils (or cookware) are suitable for surface or top burner use.

CAUTION

Never use oven cleaners, chlorine bleach, ammonia or glass cleaners with ammonia. Always allow the cooktop to cool before cleaning

Cleaning instructions

Refer to the manufacturer's user guide included in your Warranty Packet for detailed cleaning instructions.

General Cleaning

- Be sure appliance is off and all parts are cool before handling or cleaning. This is to avoid damage and possible burns.
- Use care to avoid steam burns if a wet sponge or cloth is used to wipe spills on a hot surface.
- Some cleaners can produce noxious fumes if applied to a hot surface.
- To prevent staining or discoloration, clean appliance after each use.
- If a part is removed, be sure it is correctly replaced.
- If a spillover occurs while cooking, immediately clean the spill from the cooking area while it is hot to prevent a tough cleaning chore later. Using extreme care, wipe spill with a clean, dry towel.

Electric drop in cooktops (if so equipped)



NOTE: Make sure you are connected to a 120-volt power source.

 CAUTION

Do not use aluminum foil on the electric range cooktop, as this material will damage the cooktop surface if it melts. **Do not use aluminum foil under any circumstances on the electric range cooktop.**

Gas drop in cooktops (if so equipped)

Drop in cooktops add compact high efficiency cooking performance to your recreation vehicle. Depending on your model, it may be equipped with either a 2 burner or 3 burner cooktop.

The 2 burner match-light cooktop has two 6500 BTU/H burners with control panel. The 3 burner piezo-igniter cooktop has one front 9000 BTU/H burner and two rear 5200 BTU/H burners. The 3 burner cooktop is also equipped with a control panel.

For detailed operating and cleaning information, refer to manufacturer's owner's manual.

KITCHEN RANGE & OVEN (If So Equipped)

 WARNING

During and after use, do not touch or let clothing or other flammable material come in contact with the top burners (or heating elements), burner grates or other areas near the top burners or oven until they have had sufficient time to cool. These areas can get hot enough to cause burns.

 WARNING

If using glass, glass/ceramic, ceramic, earthenware or other glazed utensils (or cookware) verify it is safe for use on the top burners. Only certain types of utensils (or cookware) are suitable for surface or top burner use.

 WARNING

Never leave cooking food unattended. Turn the pan handles inward, but not over the tops of the other range burners. Ensure that pans used are large enough to contain the food and avoid boil-overs. Heavy splattering or spills left on the cook top can ignite and cause burns.

To prevent damage, always use the manufacturer's recommended size flat bottom pan(s). Generally, the pan should be large enough to cover the burner, but not be more than one inch larger than the burner grate.

Do not use a broiler pan, griddle or any other large utensil that covers more than one burner at a time. This will create excessive heat that may cause melting, sooting or discoloration.

The use of undersized pans could expose a portion of the heating element to direct contact and may result in ignition of clothing. Proper relationship of pans to burner will improve efficiency.

SECTION 10: APPLIANCES

Refer to the manufacturer's user guide for detailed operation, cleaning and safety information.

Oven (if so equipped)

WARNING

Do not cover the oven vent openings while the oven is in operation. Restricting the flow of combustion air will create an asphyxiation hazard.

The propane gas oven must have 12-volt power to operate. If you have any questions contact your dealer or our customer service department. Do not use the oven as a storage area.

Refer to the manufacturer's user guide for detailed operation, cleaning and safety information.



NOTE: To help reduce potential condensation or unwanted cooking odors, turn on the overhead kitchen roof vent or the range hood vent (if so equipped).

GAS BBQ GRILL (If So Equipped)

WARNING

Be sure to read, understand and follow all information supplied with your recreation vehicle concerning the use of propane before operating the BBQ grill. The propane hose must be correctly connected before lighting the grill. Failure to follow instructions supplied by the grill manufacturer, or use of any components other than those originally supplied with the grill, could result in death or serious injury.

WARNING

The maximum weight limit for the bracket supporting your BBQ grill is 50 lbs. This limit includes the weight placed on the BBQ grill. Exceeding this weight limit could result in injury or property damage.

WARNING

The BBQ grill is for use outside of the recreation vehicle. **Never use this grill inside a compartment or inside of the recreation vehicle.** Before operating the BBQ grill, make sure that it is securely mounted on the support rail attached to the side of the recreation vehicle (if so equipped) or the bumper mounting bracket (if so equipped).

⚠ DANGER

Always open hood before turning on gas and lighting burner, failure to open the hood before lighting could cause an explosion causing property damage, injury, or even death.

⚠ WARNING

The BBQ grill must be COMPLETELY COOLED before storing it. The grill should be cool to the touch before storing. Storing the BBQ grill before it is completely cool may result in serious injury or property damage.

Refer to the grill manufacturer's user guide for detailed operating and safety information.

Depending on your model, your grill will be mounted with either a bumper mount system, or a rail mount on the side of your recreation vehicle.

Bumper mount (if so equipped)

- Insert the grill mounting bar (with the pins) into the bracket (mounting tube) on the rear bumper of the recreation vehicle.
- Insert the pin through the hole in the bracket and mounting bar. The pin must be installed to insure the mounting bar is secure during use.
- Tighten the T-handle on the bracket mounted to the bumper.
- Set the BBQ grill on the mounting bar by inserting the (2) pegs on the bar into the grill side mounting brackets. Make sure the mounting bar and the grill are securely in place before proceeding with the propane connection.



Bumper mounting bracket

Rail mount (if so equipped)

- Hang the grill bracket on the aluminum mounting strip located on the side of the recreation vehicle.
- Open the (2) folding arms on the bracket making sure they lock in position.
- Slide the grill onto the (2) arms against the stops. **Make sure the grill is fully on the arms.**
- Insert the retaining pins into the arms.
- To remove the grill, remove the retaining pins and simply slide it off of the bracket arms. Wait until grill has cooled down before removing it.

SECTION 10: APPLIANCES



Gas Grill & Mounting Bracket



Bracket on Support Rail

Gas BBQ Grill Prep (if so equipped)

Your recreation vehicle may be equipped with a propane “quick-coupler” connection and support bracket for easy installation of the BBQ grill.

Attaching the “quick coupler” connection

The “quick coupler” is directly connected to the RV propane system. The “quick-coupler” connection is equipped with a positive shut-off valve.

Place the “quick coupler handle in the OFF position and push back the sleeve. The valve handle must be OFF to make the connection.

1. Insert the plug and release the sleeve.
2. Push the plug until the sleeve snaps forward, locking the plug into the socket.
3. Turn the handle ON to allow propane to flow to the drop in stove.

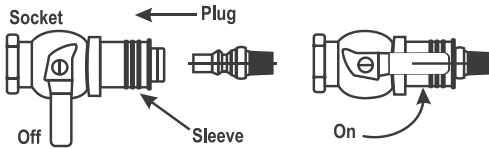

Quick Coupler Connection

ELECTRIC BBQ GRILL (IF SO EQUIPPED)

⚠ WARNING

- **POTENTIAL SHOCK HAZARD** The supply cord should be regularly examined for signs of damage and the appliance is not to be used if the cord is damaged. The appliance is rated for 120 volts – 50/60 Hz. Output: 1500 Watts. Connect cord to a properly grounded 3 prong GFI outlet only. Do not use a 2 prong adapter. **Use only Weber Q140TC temperature controlling plug.** Do not use appliance for anything other than intended.
- This grill is intended for outdoor household use only. Do not use indoors or for commercial cooking. Charcoal briquettes are ***NOT*** to be used with this appliance.
- **Use of an extension cord is not recommended.** If one must be used, use the shortest length possible. Do not connect 2 or more extension cords together. Keep connections off the ground and dry. Do not let the cord hang over the edge of the table top where it can be tripped over or pulled by children. Only use an extension cord labeled for outdoor use.
- **Never use this grill inside a vehicle compartment or inside of the recreation vehicle.**
- Make sure the grill is placed on a level stable surface free of any combustible materials.
- The BBQ grill must be **COMPLETELY** cooled before storing to avoid damaging the carrying case (if so equipped) and causing injury from handling the grill when it is hot.
- Wait until the grill is completely cooled, then store it.

Failure to follow these guidelines could result in serious bodily injury, death or property damage.

For detailed operation and safety information, refer to the manufacturer's user guide.

Using the BBO Grill

The BBQ grill is for use outside of the recreation vehicle only.

1. Place the grease collector tray in position under the grill. Do not line the catch pan with aluminum foil.
2. Preheat the grill. Turn the control knob to HIGH (clockwise). The red light indicates power is on and the heating element is heating up. The red light will periodically turn on and off as the heating element adjusts to maintain temperature.
3. Preheat time takes approximately 20 minutes at 72°F air temperature. Colder temperatures or wind can cause the preheat time to increase.
4. After preheating is complete: Leave grill set on HIGH and begin cooking



Electric BBQ Grill

SECTION 10: APPLIANCES

5. To cook at a lower grill temperature: Preheat as indicated above, then turn the control counterclockwise to the desired setting and start cooking.

Using the BBQ Grill Cart (if so equipped)

The grill can be locked onto the cart so it is more secure than just sitting on a table. The grill can be released from the cart by pressing two red buttons on the cart. The cart includes two hooks to hang grill tools on. The cart folds up as shown and the grill lid can be secured with a webbed velcro strap.

⚠ WARNING

When red light is off, heating element may still be hot!



RANGE HOOD (IF SO EQUIPPED)

If your recreation vehicle is equipped with a range hood, it will be connected to an exterior vent.

The vent has an inner flap with two snaps. This flap can be snapped shut when the vehicle is in motion, or during storage to keep insects, debris, snow, rain, etc. from entering the recreation vehicle.

Anytime the stove inside the recreation vehicle is being used, this flap **MUST** be unsnapped and the range hood turned ON to vent fumes outside the vehicle.

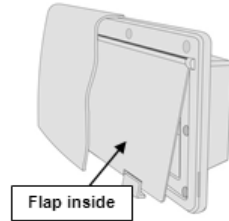

Range Hood Vent

⚠ WARNING

Whenever the stove in the RV is being used: The range hood ***must*** be turned on, and the inner flap ***must*** be unsnapped and free to move. Failure to do so can create an asphyxiation hazard by restricting air flow to this vent.

COOKING WITH PROPANE

See the *Propane System Section* for important safety instructions. Refer to the manufacturer's owners manual for detailed operating and safety instructions for all propane appliances.

IN CASE OF A GREASE FIRE

⚠ WARNING

Do not attempt to use water to put out the Fire. Water can spread some types of Fire, and electrocution is possible with an electrical Fire.

Grease is flammable. Never allow grease to collect around top burners or on the cook top surface. Wipe up spills immediately. Refer to Section 2 – Safety Precautions, for fire safety and fire extinguisher information.

REFRIGERATOR

The refrigerator is not intended for quick freezing or cooling. We recommend stocking it with pre-frozen or pre-cooled food when possible. The shelves should not be covered with paper or plastic and the food items should be arranged so air can circulate freely. Keep the area at the back of the refrigerator clean and free of debris. Check for obstructions in the exterior refrigerator vent area (i.e., spider webs, bird nests, etc.). Use a soft cloth to dust off the debris.

For optimum efficiency and performance, it is recommended the refrigerator be checked at least twice a year as part of the routine maintenance.

Gas/electric models (If So Equipped)

⚠ WARNING

If you smell propane gas **STOP!** Follow the directions located in your manufacturer’s owner’s manual and in this manual.

Residential models (If So Equipped)

For detailed operating and safety information, refer to the manufacturer’s user guide included in the Warranty Packet.



NOTE: If you are using electric to power the refrigerator, make sure you are connected to a 120-volt power source.

⚠ CAUTION

The ice maker (if so equipped) should be turned off and the ice tray emptied when power to your recreation vehicle has been shut off. With no power, the ice will melt and water may “pool” in the refrigerator door. When power is restored, the vibration may cause this water to run out of the door and on to the vehicle floor.

SECTION 10: APPLIANCES

CLEANING YOUR REFRIGERATOR

The following are general cleaning guidelines. For detailed information on cleaning your specific refrigerator, refer to the manufacturer's user's guide.

Cleaning the interior

1. Unplug refrigerator or disconnect power.
2. Hand wash, rinse, and dry removable parts and interior surfaces thoroughly. Use a clean sponge or soft cloth and a mild detergent in warm water.
3. For the inside of the refrigerator, use a warm water and baking soda solution consisting of approximately 1 tablespoon (15ml) baking soda to 1 quart (1 liter) of water. This solution both cleans and neutralizes odors. Rinse and wipe dry.
4. Leave an open box of baking soda in the refrigerator and freezer compartments to help prevent odors.



NOTE: Do not use abrasive or harsh cleaners such as window sprays, scouring cleansers, flammable fluids, cleaning waxes, concentrated detergents, bleaches or cleansers containing petroleum products on plastic parts, interior and door liners or gaskets. Do not use paper towels, scouring pads, or other harsh cleaning tools.

There is no need for routine condenser cleaning in normal operating environments. If the environment is particularly greasy or dusty, or if there is significant pet traffic, the condenser should be cleaned every 2 to 3 months to ensure maximum efficiency.

If you need to clean the condenser:

- Remove the base grille.
- Use a vacuum cleaner with a soft brush to clean the grille, the open areas behind the grille and the front surface area of the condenser.
- Replace the base grille when finished.

Cleaning the exterior

Painted metal exteriors: wash with a clean sponge or soft cloth and a mild detergent in warm water.

Stainless steel exteriors: wash with a clean sponge or soft cloth and a mild detergent in warm water. Do not use appliance wax, polish, bleach, or other products containing chlorine on stainless steel. Stainless steel can be cleaned with a commercially available stainless steel cleaner. A spray-on stainless steel cleaner works best.

IMPORTANT: Do not allow the Stainless Steel Cleaner and Polish to come into contact with any plastic parts such as the trim pieces, dispenser covers or door gaskets. If unintentional contact does occur, clean plastic part with a sponge and mild detergent in warm water. Dry thoroughly with a soft cloth.

For silver-accented plastic parts, wash with soap or other mild detergents. Wipe clean with a sponge or damp cloth. Do not use scouring pads, powdered cleaners, bleach or cleaners containing bleach as these products can scratch and weaken the paint finish.

WASHER/DRYER PREP (IF SO EQUIPPED)



If your recreation vehicle was built with washer/dryer prep, be aware the cabinet space provided is intended for the installation of an aftermarket washer/dryer combo unit (customer supplied) only. Please consult your dealer or the manufacturer for installation assistance.

A dryer vent opening must be cut into the sidewall of the recreation vehicle if installing a dryer. A label has been installed to assist you in placing the vent in the correct location. The label will be located in the area where the dryer will be installed.



Dryer vent label

Look for the dryer vent label on the wall in the location where the dryer will be installed. Instructions on how to cut the dryer vent hole and how to install the dryer vent in the wall of the recreation vehicle are included in your warranty packet.

 CAUTION
Do not operate a dryer in the recreation vehicle unless the dryer is properly vented.
 WARNING
Gas dryers should NEVER be installed in your recreation vehicle. Dryer prep has been designed for electric dryer operation <u>ONLY</u> .

CENTRAL VACUUM SYSTEM (IF SO EQUIPPED)

The following is an overview of the central vacuum system operation. For detailed operating and safety instructions, refer to the manufacturer's user guide.

The central vacuum system installed cleans virtually any surface with no electric cords and has a variety of attachments for many cleaning needs. Make sure you have 120-volt AC power available before operating your central vacuum system (refer to *Sec. 6 Electrical Systems*, calculating electrical load).

To operate the central vacuum system lift the vacuum cover, and attach your vacuum hose and cleaning attachment. The central vacuum will automatically activate. It has a large disposable bag that will need to be checked periodically and replaced after usage. The disposable bag is located inside the exterior cargo compartment.

SECTION 10: APPLIANCES

⚠ WARNING

DO NOT PICK UP ANYTHING THAT IS BURNING OR SMOKING, SUCH AS CIGARETTES, MATCHES, OR HOT ASHES. RV damage, personal injury, or death may result from vacuuming up burning or smoking material.

⚠ WARNING

DO NOT PICK UP FLAMMABLE OR COMBUSTIBLE LIQUIDS SUCH AS GASOLINE, OR USE IN AREAS WHERE THEY MAY BE PRESENT. RV damage, personal injury, or death may result from vacuuming up flammable or combustible material.

RECHARGEABLE VACUUM (If So Equipped)

The portable vacuum is equipped with a rechargeable battery pack which can be plugged into a 120V AC wall outlet. Refer to manufacturer's user guide for important safeguards and operating instructions. Read all instructions before operating the vacuum cleaner.

WATER HEATER – SEE PLUMBING SECTION

SATELLITE (IF SO EQUIPPED)

Please refer to the manufacturer's instructions for setup, care and maintenance.

HDTV ANTENNA (IF SO EQUIPPED)



King Jack HDTV antenna



Enclosure base

Y o u r

recreation vehicle may be equipped with one of two types of exterior high definition TV antenna. Both antennas are capable of receiving any over the air (OTA) high definition television signals being broadcast in your receiving area.

King Jack Antenna Positioning: The knob on the enclosure base inside the recreation vehicle is used to rotate the outdoor roof antenna. The arrow on the knob should be pointed towards the TV signal source (the TV station). Press the button on the side of the knob and turn it to rotate the antenna for optimum signal. The antenna will rotate a full 360°.



NOTE: This antenna is a fixed height (12") and cannot be lowered or raised. Trees and foliage will interfere with receiving a strong HDTV signal.

Refer to the HDTV manufacturer's manual for detailed operating and safety information.



Winegard HDTV antenna



Interior Base

Winegard Antenna Positioning: The knob on the interior base will rotate the antenna. Push up slightly on the inner piece, and rotate the knob to reposition the antenna. The antenna will rotate a full 360°. This antenna has a built in amplifier

SECTION 11: ELECTRONICS

NOTE: This antenna is a fixed height (8.4") and cannot be lowered or raised. Trees and foliage will interfere with receiving a strong HDTV signal.

Refer to the HDTV manufacturer's manual for detailed operating and safety information.

EXTERIOR SLIDING / PIVOTING TV

Your recreation vehicle may be equipped with a TV located in an exterior compartment that allows you to slide it in and out of the compartment, along with the ability to pivot and reposition for viewing.

Extending the TV for viewing

1. Push down on the yellow tipped lever to release the sliding bracket.
2. Hold the yellow lever down (A) and pull the TV towards you out of the compartment. Once you start sliding the TV out, release the lever and continue pulling the TV out towards you. Make sure the cords do not get caught up in the mechanism as the TV is pulled out.
3. With the silver brackets (on the back of the TV) extended, the TV is not completely out of the compartment. Keep pulling on the TV until the top black slide bracket (B) is all the way out to the end of the channel (C). The TV should clear the lined panel inside the compartment when it is completely extended (D).
4. To pivot the TV into viewing position, pull up on the T-handle (E) which releases the TV to pivot freely. Move the TV into the viewing position.

NOTE: The TV does not lock into place when it is in this pivoting position.

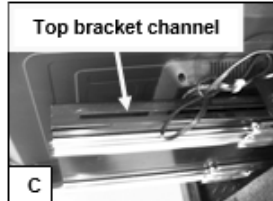
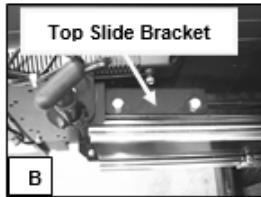
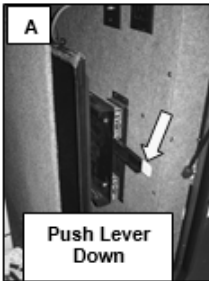

Retracting the TV for storage

1. Rotate the TV back into the storage position so the T-handle locks back in place to keep the TV from pivoting (E).
2. Push the TV into the storage compartment taking care not to get the power cord or the antenna cable caught in the mechanism.
3. Push it all the way back into the compartment until it stops. Firmly push it into place until the yellow tipped lever locks it in place. You will hear it click when you have it latched properly.

SECTION 11: ELECTRONICS

Notes:

CLEANING THE INTERIOR

To keep the value of your recreation vehicle, perform regular maintenance using the proper materials and procedures. Using the wrong cleaner may result in damage to the surfaces in your vehicle. Check with the manufacturer's information for the recommended cleaning agent. If in doubt, check to see if the cleaner will cause damage by testing a small area out of sight or contact your dealer for assistance. Do not use flammable liquids or sprays to clean the recreation vehicle.

DÉCOR ITEMS

Décor items such as décor glass, furniture, window treatments, shades and blinds should be cared for as follows:

Décor Glass (if so equipped)

Use a glass cleaner to remove smudges, smears and spots. If there is any decorative etching on the décor glass, use care when cleaning around that area.

Furniture Upholstery

To retain the value of your recreation vehicle, maintain the furniture upholstery carefully and keep the interior clean. Vacuum the furniture regularly using a soft brush attachment to remove any loose dirt or debris.

Fabric (if so equipped)

It is recommended the fabric be professionally cleaned if it becomes stained or soiled. The professional cleaner should be made aware the fabrics that may have been treated to be fire resistant. For more information, refer to the specific furniture manufacturer's care instructions.

Ultraleather™ (if so equipped)

It is recommended the Ultraleather™ be professionally cleaned if it becomes stained or soiled. For more information, refer to the specific furniture manufacturer's care instructions.

Leather (if so equipped)

Periodic vacuuming, using a dry cloth to wipe up spills immediately, and using a damp cloth on problem areas, will help to keep your leather furniture in good condition. Leather surfaces can vary as do the cleaning methods. Refer to the furniture manufacturer's recommendation, or consult a cleaning professional.

It is recommended you do not use any cleaners containing oils, waxes or silicones. Cleaners containing silicone can eventually destroy the finish on the leather. Cleaners containing oils or waxes should not be used as they leave residues on the surface of the leather which can attract more dirt which can eventually lead to cracking

Window treatments

Fabric – Drapes and valances

Dust occasionally with a vacuum and soft brush attachment. It is recommended the fabric be professionally cleaned if it becomes stained or soiled. The professional cleaner should be made aware the fabrics that may have been treated to be fire resistant.

Window Shades

Shades should be vacuumed periodically to remove dust. It doesn't matter what type of shade or fabric you have, using your vacuum cleaners upholstery brush on low suction will remove most dust and dirt from the shade.

Refer to the shade manufacturer's owner's manual for additional and detailed information.

SECTION 12: INTERIOR

To remove stuck on dust or stains refer to the following guide.

Solar shields: Use a sponge or soft brush and water to remove stains. A mild cleaning solution can be used to remove tougher stains. Rinse after cleaning by wetting a clean cloth in fresh water, wringing out any excess and wiping the areas where the cleaner was used.

Day/night Shades: Clean with a mild cleaning solution using a sponge or paper towel. Wipe down with water after cleaning and dry thoroughly before raising the shade. Do not use spot remover, household cleaners or detergents to remove soiled spots, as these may cause damage to fabric or loss of color from fading.

Mini Blinds: A simple dry rag may do the trick. If they're especially dirty, you can use cold or warm water to clean them. But never use hot water.

Fill a spray bottle with water and a tiny amount of soap. Then spray a lint-free towel with the mixture and use the towel to wipe down each slat. While cleaning, try not to bend the slats. They can also be soaked in a bathtub to loosen up any debris so the slats can be wiped down easily.

Roller Shades: Can be easily cared for by simply using soapy water or a mild cleaning solution on spots. However try a small area first. Harsh household cleaners or detergents may cause damage to fabric or loss of color. It is our recommendation to dust the rails and fabrics of the shades on a regular basis. Shades should be kept in the closed or up position when not in use, to maintain pleat retention and minimize dirt and soil build-up. Do not store shades in the down position. This may cause some loss of pleat retention if the shades are not operated on a consistent basis.



NOTE: If your recreation vehicle must be stored for an extended period of time, store shades in the up position and cover your windows with additional protection (I.E. Cut out cardboard).

SOFA

Your recreation vehicle may be equipped with one of the following sofa styles.

Hide-a-bed Sofa or Sofa Sleeper

The hide-a-bed sofa functions much the same as a regular residential hide-a-bed sofa. To make the hide-a-bed sofa into a bed, remove the seat cushions and pull the sofa back towards you firmly and gently. Activate (or deflate) the air mattress (if so equipped) using the supplied furniture manufacturer's instructions. To convert the hide-a-bed back into the upright sofa position, reverse the process.

Jack Knife Sofa

The Jack Knife sofa functions much the same as a residential futon. To make the sofa in to a bed, lift up on the bottom seat cushion and pull it towards you. The sofa back will drop down to provide a sleeping surface. For additional comfort and to reduce fabric damage, you may want to place a cover or air mattress (customer supplied) over the sofa when it is in the sleeping position.

Trifold Sofa The Trifold

Sofa offers very similar features to the traditional hide-a-bed. The following illustrations detail converting the sofa into a bed.



1. Remove tri-fold sofa pillows and set aside



2. Using the strap handle, pull sleeping surface up, then out.



3. While sleeping surface is up, gold out legs. Extend sleeping surface until grounded.



4. Once sleeping surface is grounded, fold headboard down flat.

J-Cube Sofa

The J-Cube Sofa functions similar to a residential futon. The slanted back pillows offer numerous options as a sofa, along with the ability to extend the cushions for additional sleeping space.

FREE-STANDING TABLE & CHAIRS (IF SO EQUIPPED)

The free-standing dinette table can be positioned to seat up to four people. To prevent damage, the standard free-standing dinette chairs should be fastened securely at the dinette table when you are traveling

BOOTH DINETTE (IF SO EQUIPPED)

The dinette is designed to seat up to four adults. Depending on your model, there may be a storage area in the dinette bench. To access this storage, remove all the cushions and lift up on the bottom seat support. **If the bottom seat support is secured closed with screws, do not remove the seat support or use this area for storage.** The dinette seats that are secured with screws contain factory installed equipment and should only be accessed by a qualified service technician.

Converting the dinette to the bed position

Remove all the cushions from the booth dinette. Lift up the tabletop and remove the detachable table legs. Place the tabletop on the ledges provided between the booth dinette benches. Lay the seat back cushions against the back of the dinette bench. Lay the dinette seat bottom cushions in between the seat back cushions. The area where the cushions meet should be slightly raised. Push the raised cushion ends down gently as the cushions are designed to fit snugly. Reverse this process when converting back to the booth dinette.

SECTION 12: INTERIOR

CABINETRY & TABLES

To keep hardwood doors, cabinet fronts and hardwood tables looking like new regularly dust with a soft cloth dampened with a cleaning polish or mild detergent solution. Avoid using ammonia based products or silicone oils as they may cause damage if used over a long period of time.

The finish is durable and resistant to most household spills. However, spills should be wiped up promptly to avoid potential problems. Excessive prolonged exposure to direct sunlight, high temperatures and high humidity can cause damage to both the finish and the wood itself. These should be avoided.

PANTRY OR HUTCH (IF SO EQUIPPED)

Depending on the kitchen layout of your recreation vehicle, you may have a pantry or hutch that you can use to store items you wish to take with you as you travel and camp. Make sure all items stored in the pantry or hutch are secured so they do not shift during travel. This cabinetry has been designed to accommodate the normal camping items (i.e., paper plates, flatware, cookware, etc.) which are bulky but not necessarily heavy. **Remember your recreation vehicle's load capacity is designed by weight, not volume, so you cannot necessarily use all available space.**

If your pantry or hutch has sliding pantry shelves, they have been equipped with a locking mechanism to keep them in place during transit. To secure the shelf in place, push it all of the way in until the latch tab clicks into place. Always pull out slightly on the shelf to make sure that it is stationary and secure in the transit position. To release the shelf, push in on the tab and pull the shelf slowly towards you.

WARNING

Your recreation vehicle's load capacity is designated by weight, not by volume, so you cannot necessarily use all available space when loading the vehicle. Do not exceed your GVWR and ensure you are loading the vehicle as evenly as you can for the best possible handling. Ensure heavy items are secured so they do not shift during travel.

COUNTERTOPS

To prevent permanent damage

- Always use hot pads or trivets under hot pans, dishes, or heat producing appliances such as frying pans.
- Always use a cutting board; never use a knife on the countertop.
- Avoid harsh chemicals such as drain cleaners, oven cleaners, etc.
- Do not let cleaners with bleach set on the top. Wipe them off promptly.

For additional information on the removal of difficult stains or surface damage repair, refer to the countertop manufacturer's user guide.

Your recreation vehicle may be equipped with one or both of the following countertops.

Laminate countertops (if so equipped)

Glass rings, food spills, water spots and smudges usually wipe off with a damp sponge. Stubborn stains can be removed with a general-purpose spray cleaner. Some stains can be

removed by squeezing fresh lemon juice over the stain and allowing the juice to soak for approximately forty-five minutes. After 45 minutes, sprinkle baking soda over the lemon juice and rub with a soft cloth.

Solid surface countertops (if so equipped)

Solid surface materials are easy to care for, and if damaged, easy to repair. Soapy water, ammonia based cleaners (not window cleaners as they can leave a waxy build up that may dull the surface) or commercially available solid surface cleaners will remove most dirt and residue from all types of finishes. A damp cloth followed by a dry towel will remove watermarks.

Difficult stains can be removed from the matte finish with a green Scotch Brite® pad and a mild abrasive cleaner.

Disinfect the surface periodically with diluted household bleach (one part water to one part bleach). For cuts and scratches, sand the matte finish lightly with (220) fine grit sandpaper until the cut or scratch is gone. Restore finish with a green Scotch Brite® pad and mild abrasive cleaner.

Helpful hints

- Use a cutting board to prevent unnecessary damage to the countertops. Do not cut directly on the solid surface countertop.
- Use potholders or trivets before placing hot pots and pans on the countertop. Heat will damage the countertop.
- Run cold water when pouring hot/boiling water into the sink.

Solid surface sink maintenance

Occasionally, clean the solid surface sink by filling one-quarter full with a 50/50 water/bleach solution. Let soak for 15 minutes, and then wash sides and bottom of sink as solution drains.

INTERIOR WALL PANEL

Please contact your dealership service department for assistance in repairing décor paneling. If deep scratches occur on the wall panel, putty sticks can be used to cover scratches on wood surfaces. These can be obtained from local hardwood stores and lumberyards.

To clean, use a mild solution of soap and lukewarm water with a soft sponge or cloth. Wipe dry with a soft, clean cloth.

 CAUTION
Do not use abrasive cleaners as they may cause the vinyl to scratch and become dull. Do not use cleaners that contain bleach.

FLOORING

Always test a cleaning agent in an inconspicuous area for colorfastness.

Carpet

Vacuum your carpet regularly. It is important to remove loose soil and debris while it is on the surface. Heavily traveled areas (i.e., walkways, areas in front of the furniture) may be protected with small throw rugs to prolong the life of the carpet.

Prompt attention to spots and spills is essential. Remove as much of the spill as possible.

SECTION 12: INTERIOR

Absorb wet spills as quickly as possible by blotting repeatedly with white paper or cloth towels.

Refer to the manufacturer's guide included in your Warranty Packet for detailed cleaning information, or contact a cleaning professional.

Vinyl flooring

Periodically vacuum or sweep to remove dirt and gritty particles. Although most common spills will not permanently stain the vinyl floors, they are usually easier to remove if wiped up before they set. Simply blot with a paper towel and wipe clean with a damp cloth. Do not use dish detergents or vinegar and water because they will dull your floor.

To care for the vinyl floor covering, use a damp mop with water and a mild cleaner on the entire floor. **DO NOT SOAK THE FLOORING.** Use care to avoid wetting the carpet edges. To avoid problems of "yellowing" linoleum, the flooring manufacturer recommends avoiding cleaners that contain oil based solvents (i.e. cleaners containing lemon oil, Murphy's Oil Soap, etc.).

LOFT SLEEPING AREA (IF SO EQUIPPED)

Depending on the model of your recreation vehicle, it may be equipped with a loft sleeping area. Access to the loft sleeping area is through the use of a (wood or metal) ladder.

The metal ladder is equipped with hooks that fit over the side board of the loft bed.

Typically the wood ladder is attached to a closet door and pivots out for use. Be sure the door is closed and latched, and the ladder is securely in place before climbing up to the loft area. When storing the ladder to the door, make sure to buckle the security strap which helps keep the ladder in place on the door.

The following photos represent a typical loft area. Depending on your model the loft area appearance and design may be different.



Loft Sleeping Area



Ladder access to sleeping loft



NOTE: Do not use the loft sleeping area for storage while the vehicle is in transit. Loose items may become projectiles.

 WARNING

DO NOT EXCEED MORE THAN 600 LBS. ON THE BED.

Never allow anyone to ride in or occupy the bed while the recreation vehicle is in motion.

 WARNING

- Exercise extreme care when climbing up or down the ladder (either steel or wood) used for entering or exiting the loft bed.
- Closet door **MUST** be securely closed and latched before using the ladder.
- Make sure the ladder is securely in place prior to climbing to or from the loft.
- Never allow more than one person on the ladder at a time.
- Make sure the wood ladder attached to the door (if so equipped) is locked back into position on the door when not in use to prevent a trip hazard.
- Do not leave small children unattended in the loft area.
- Failure to follow these instructions can result in serious bodily injury.

ABS PLASTICS

Dust and wipe clean with soft, damp cloth or chamois, wiping gently. Do not use gritty or abrasive particle soaps or scouring compound to clean ABS plastic. Avoid using “citrus” or biodegradable cleaners which contain “D-Limonene” as they may damage plastic materials.

FLOOR SAFE (IF SO EQUIPPED)

Your recreation vehicle may have a safe which is typically mounted to the floor of the closet or under the bed. The safe is intended to help to safeguard valuable items. Jayco cannot be held liable for loss of personal property that is placed within the safe. To secure items in the safe, utilize the key provided with the safe and lock it after placing items in the box. Store the key in a location away from the safe.

SECTION 12: INTERIOR

Notes:

CLEANING THE EXTERIOR

To protect your recreation vehicle's exterior finish, wash it often and thoroughly.

For recreation vehicles with painted exterior graphics: If desired you may wash and wax your vehicle 60 days after purchase. The exterior paint does need time to cure before any wax is applied to the exterior surface. Careful maintenance for the first 60 days will assure a long lasting durable finish.

Your recreation vehicle is exposed to many environmental conditions that have an adverse affect on the paint finish:

- Road Salt and Sodium Chloride
- Road Tar / Bugs
- Bird Droppings / Tree Sap
- Industrial Fallout / Acid Rain /Pollution
- UV Exposure and Moisture

The most common problems resulting from these conditions are corrosion, staining, and chemical spotting. Generally, the longer the foreign material remains in contact with the exterior finish, the more extensive the damage. These problems can be minimized by regularly scheduled washing and polishing. Wash your recreation vehicle as soon as possible if it becomes contaminated with foreign material.

Avoid parking under trees or near ocean sea salt. Ice or snow should not be scraped from the painted surface: Brush off!

Gravel roads should be avoided. Anti-freeze, gasoline or washer solvents if spilled on the painted surface should be rinsed off with water immediately. Bugs and bird droppings should be rinsed off daily.

Washing

Commercial washing should be avoided. Wash with cold water using a mild liquid soap. Dry wiping with a dry cloth is not recommended.

Make sure the recreation vehicle's surface temperature is cool, under 90 F, and out of direct sunlight. A shaded area is ideal for washing your vehicle as direct sunlight causes water spotting. Use a mild soap or detergent. Most auto care stores will carry a car wash shampoo. Try to avoid combination wash-n-wax products as these waxes can cause build up and are designed for smaller surfaces. Have two dedicated sponges or wash mitts: one for the exterior walls and one for the wheels and under- carriage. Brushes or wash mitts that are made of plastic bristles are acceptable for use on tires and wheel wells, but are not intended for use on the exterior walls. Avoid using such items on painted surfaces as they will damage the finish. Wash the wheels and wheel wells first as this removes heavy dirt and debris and prevents it from splattering on panels. Wet the entire area down to remove loose dirt and grime, then hand wash one area at a time using your dedicated paint finish sponge or wash mitt.

Wash from the top and work your way down, rinsing frequently to minimize grit abrasion. Follow with a final rinse of water. This process will remove most contamination from the recreation vehicle's surface. For stubborn stains such as road tar or bug stains, use an ammonia based glass cleaner or a small amount of rubbing alcohol on a damp cloth followed immediately by warm soapy water, and rinsing with clean water.

This may not dissolve the road tar, but it will loosen tar and bug stains and remove them

SECTION 13: EXTERIOR

from the surface. Do not use solvent based cleaners on bird droppings or tree sap as these are water based stains. They can be dissolved using ammonia based glass cleaner, warm soapy water and a little “elbow grease”. Once again, after removing stubborn stains immediately rinse with clean water.

Drying the recreation vehicle is just as important as washing your vehicle. Tap and well water contain many chemicals that could water stain your vehicle’s finish. We suggest using a damp natural or synthetic chamois. There are other drying products such as lint-free micro-fiber towels that work just as well.

During cold weather

Salt and other chemicals that are spread on winter roads in some geographical areas can have a detrimental effect on the recreation vehicle’s underbody. **If your recreation vehicle is exposed to these conditions, spray the underbody with a high-pressure hose every time you wash the exterior of your recreation vehicle.**

Take special care to remove mud or other debris that could trap and hold salt or moisture. After washing your recreation vehicle, wipe off all water drops from the rubber parts around the slideout and doors.



NOTE: When the slideout or door is frozen, opening it by force may tear off or crack the rubber gasket that is installed around the slideout or door. Therefore, pour warm water on the gasket to melt the ice (wipe off the water thoroughly after opening the slideout or door). To prevent the weather stripping from freezing, treat it with a silicone spray.

Waxing

Wax your recreation vehicle once or twice a year, or when painted surfaces do not shed water well. Use a soft cloth to apply a small amount of wax to the painted surfaces. After the wax has dried, polish the recreation vehicle with a dry, soft cloth. Do not wax your recreation vehicle in direct sunlight. Wax it after the surfaces have cooled.

Do not apply wax to any area having a flat black finish as it can cause discoloration. If the finish has been stained with wax, wipe off the area with a soft cloth and warm water. When waxing the area around the various openings, do not apply any wax on the weather-strip. If it is stained with wax, the weather-strip cannot maintain a weatherproof seal around the opening.



CAUTION

Do not use waxes containing high-abrasive compounds. Such waxes remove rust and stains effectively from the paint work, but they are also harmful to the luster of the painted surface since they scrape off the coating. Further, they are detrimental to glossy surfaces, such as the grille, garnish, moldings, etc. do not use gasoline or paint thinners to remove road tar or other contamination to the painted surface.

Polishing your recreation vehicle

If painted surfaces have been severely damaged and have lost their original luster and color tone, polish the surface lightly with a fine polishing compound. Avoid limiting your polishing to the damaged surface only; polish a somewhat wider area, moving the polishing cloth in one direction. After polishing, flush the compound from the surface and apply a coat of wax to regain a beautiful luster.

 **CAUTION**

Do not use a buffer and a buffing compound as it may damage the exterior surface. Please contact a professional paint body shop for assistance.

Damaged paint

To prevent corrosion, touch up small cracks and scratches in the paint coat as soon as possible with touch-up film or paint. Carefully check the body areas facing the road and the tires for damage to the paint coat caused by flying stones, etc. To purchase touch-up paint, use the closest automotive paint (available locally) match possible.

Cleaning plastic parts

Use a sponge or chamois to clean plastic parts. Use warm water and a soft cloth or chamois to remove any white residue from dark colored plastic surfaces. Do not use a scrubbing brush, other hard tools, or wax containing abrasives as they may damage the plastic surface.

 **CAUTION**

Do not allow plastic to come into contact with brake fluid, engine oil, grease, paint thinner, or battery acid. These will damage plastic. Use a soft cloth and a mild detergent solution to wipe away any such contact..

Chrome parts

To prevent chrome parts from spotting or corroding, wash with water, dry thoroughly, and apply a non-abrasive automotive wax. If the chrome is severely damaged or pitted, use a commercially available chrome polish product.

FRAME

Sand, pebbles, objects on the highway, climate (salt air exposure) or ice inhibiting chemicals used during the winter months will damage the paint, inviting rust and other deterioration. Periodically inspect the exterior exposed areas, clean and repaint the frame members occasionally and whenever you notice rust or paint chipped away, to insure protection.

FRONT AXLE TIRE ALIGNMENT

The term alignment refers to both the adjustment angles on the steering axle and suspension and tracking of the rear axle. Many factors are considered when establishing proper alignment. Steering components, suspension, wheel bearings and even proper loading will affect your motor home alignment. **To ensure accuracy, your motor home was aligned and weighed at our manufacturing facility before shipment to your dealer.** It is your responsibility to have the alignment inspected periodically to maintain vehicle steering performance and prevent uneven tire wear as part of your normal.

SECTION 13: EXTERIOR



NOTE: Always have the alignment checked and adjusted by a qualified shop with the proper equipment to handle heavy vehicles.



NOTE: A road test by the dealer should be included as part of the pre-delivery inspection. The dealer can check for and correct any steering problems before you take delivery of the motor home. After this road test has been completed, front-end alignment and/or vibrations will not be covered as part of the new vehicle limited warranty.

EXTERIOR ROOF & SIDEWALL VENTS

While you are cleaning the exterior roof assembly, also inspect the roof vents (including sealants) for cracks and keep them clean. Inspect the refrigerator and holding tank vents for blockages from bird nests, spider webs, leaves, etc. All exterior access doors and vents need to be kept clean and free of obstructions (i.e., insect nests, mud daubers, etc.) while the appliances are in use.

WINDOWS

Any ventilating window may permit water inside, especially during heavy rainstorms. Condensation will also cause water to accumulate on windows and in the tracks.

The window “glass” can normally be cleaned with a sponge and water. Use glass cleaner to remove wax, oil, grease, dead insects, etc. After washing the glass, wipe it dry with a clean, soft cloth.

EXTERIOR LADDER (If So Equipped)

Your recreation vehicle may be equipped with an optional roof ladder. The recreation vehicle roof has decking under the rubber roof membrane to allow you to walk on the roof (with caution) to do maintenance.

WARNING

If your recreation vehicle is equipped with a roof ladder, do not leave items attached to it while traveling. The ladder weight capacity should not be exceeded (see ladder capacity label). **DO NOT** exceed this weight limit. There should never be more than one person on the ladder at the same time

SEALANTS

CAUTION

Failure to properly maintain or reseal your recreation vehicle may result in serious water damage to the roof and other parts of the recreation vehicle. This damage is not covered by the Towable Limited Warranty..

Sealants perform a very important function and should be inspected closely and regularly maintained. We incorporate many different types of sealants, including butyl/putty, black butyl-encapsulated foam, silicone (clear and colored), roof sealant and foam. In general, sealants do not have “set” lifetimes. Varying environmental factors affect the pliability and adhesiveness of sealants.

You or your dealer must:

- Inspect all sealants, a minimum of every six months. Make sure to check the roof and all four sides of the recreation vehicle including all moldings, doors, vents and exterior attachments. A quick walk around the recreation vehicle before leaving may help prevent potential problems during trips and vacations.
- Have the sealant replaced if you notice any cracks, peeling, voids, gaps, breaks, looseness or any sign of physical deterioration. Reseal at least one time each year as preventative maintenance.
- Always use the same type of sealant that was removed. Your dealer recreation vehicle service or parts manager can help you obtain the correct sealant(s).

The sealants may become damaged due to road vibration, ultraviolet exposure, air pollution, freezing temperatures and exposure to other elements. If deteriorated, repair immediately to prevent damage.

If you notice water inside the recreation vehicle, immediately have the dealer check for the source of the leak. Failure to correct the leak may result in serious damage to your recreation vehicle; this damage may not be warrantable.

Although the diagrams below may not accurately reflect the exact model of your recreation vehicle, make sure you inspect all sealants as indicated in the text. If you have questions and/or need assistance with sealing your recreation vehicle, consult with your recreation vehicle dealer.

FIFTH WHEELS - SEALANT DIAGRAM

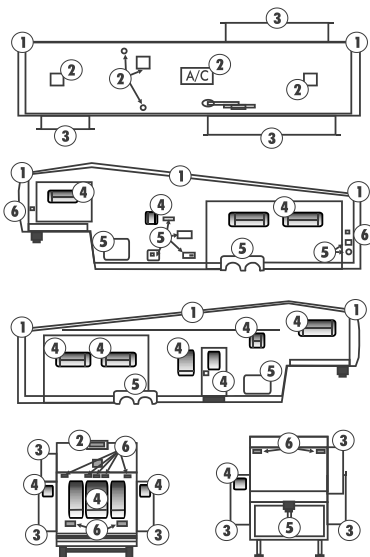

- 1. Trim Edges
- 2. Roof items
- 3. Slideout Roof/Floor
- 4. Windows/Doors
- 5. Storage Compartments/
Access Doors/Wheel Wells
- 6. Lights

SECTION 13: EXTERIOR

Notes:

RV START-UP

The following checklist will help ensure a trouble-free camping season:

- Inspect and work all interior and exterior latches and locks (lube if necessary).
- Make sure the batteries are fully charged and installed correctly.
- Inspect the power cord and carefully clean the contacts if necessary. Plug in the power cord to an appropriate power source.
- Turn on the interior lights and check outlets for polarity. If needed, replace any blown fuses. Check the circuit breakers and test the GFCI.
- Inspect and test all safety detectors. If needed, replace any drained or discharged batteries. If you have a defective or damaged safety detector, replace it immediately.
- Inspect and turn on the propane system. If you have any questions, contact your dealer or a qualified propane service representative for assistance.
- If the propane system is functioning properly, test any pilot lights or direct spark ignition features.
- Inspect the leveling jacks (if so equipped) for operation. If needed, perform maintenance as specified by the leveling jack manufacturer.
- Test all exterior and interior lights. Replace any bulbs if they are burnt out.
- Inspect the tires for wear, cracks and inflation pressure.
- Wash the exterior of the RV. Do a sealant inspection and repair as necessary.
- De-winterize and sanitize the fresh water system.
- Connect your tow vehicle to the RV and test all connections and lights.

READY TO LEAVE & MAINTENANCE CHECKLIST

Before leaving or returning home, it is critical that you complete the necessary procedures to ensure a safe trip. This is a general list, which you may want to customize as you determine your own needs

- Make sure you follow all safety precautions noted in this owner's manual and in any manufacturer's operators manual when preparing to travel.
- Check the area under the RV after overnight parking and look for water or other fluid leaks. If leaks are detected, find the cause and correct it immediately.
- Make sure all tow vehicle fluids are at proper levels. Check the engine oil, transmission fluid, engine coolant, power steering fluid and wind shield washer fluid.
- Check the lights on the RV. Have someone observe the operation of all exterior lights while you activate the controls. Check the turn signals and brake lights.
- Examine the tires for excessive tread wear or uneven wear patterns. Check for stones, nails, glass or other objects lodged in the tread. Inspect for tread cuts or sidewall cracks.
- Check wheel lug nuts for tightness and tires for proper air inflation pressure.
- Check the propane cylinder gauge to make sure there is propane available. Make sure the propane cylinder is in place and secure for transport.

Interior

- Close roof vents.
- Close windows & latch blinds.

SECTION 14: TRAVEL/CAMPING/STORAGE CHECKLISTS

- Counter items put away or tied down.
- Furnace turned off.
- Latch drawers, cabinets & doors.
- Turn off interior lights and appliances.
- Disconnect any cable TV or phone hookup, and lower the TV antenna (if so equipped).
- Move slideout(s) in and lock it in place (if so equipped).
- Fasten and secure the furniture for travel (if so equipped).
- Refrigerator door locked (if so equipped).
- Set refrigerator to 12-volt (if applicable).
- Water pump and water heater turned off (if so equipped).

Exterior

- Empty black and gray holding tanks, rinse as needed (if so equipped).
- Pack equipment into compartments and secure it.
- Propane turned off.
- Retract awning and secure in place for transport (if so equipped).
- Retract step.
- Snap the Range Hood vent closed (if so equipped)
- Retract leveling jacks to the travel position (if so equipped)
- Water hose & electric cord unhooked and stored.
- Test brakes for proper operation.
- Secure any loose, heavy or sharp objects in the RV or exterior compartments.
- Fasten all interior and exterior doors securely. Lock them (if so equipped).
- Secure and lock the entrance door.
- Walk around your RV one last time to make sure everything is stored away and the baggage compartments are closed and locked.

Maintenance Checklist

This list is a quick reference sheet for suggested areas of regular maintenance. Review all manufacturer's operators manuals supplied with your RV to perform these listed maintenance items.

Prior to First Trip

- Inspect and reseal as needed.
- Have the propane system checked for leaks by your dealer.
- Check wheel lug nuts at specified intervals to listed torque specifications, re-torque as needed.
- Sanitize the fresh water system.
- Test the safety alarms.

First Two-Hundred Miles

- Check wheel nuts at specified intervals to listed torque values. Re-torque as needed.
- Have brakes adjusted by a qualified service technician.
-

Each Trip

- Inspect and reseal as needed.
- Check the auxiliary battery (If so equipped).
- Have the propane system checked for leaks by your dealer.
- Check running lights.
- Check tire pressure and wear, including spare (if so equipped). Make sure the tires are cold when checking the tire pressure.
- Flush out water heater tank.
- Inspect safety chains for signs of wear.
- Test brakes.
- Test safety alarms.

RV STORAGE

Properly preparing your RV for storage during periods of non-usage will prevent problems from arising. It will also make it easier to get started again for the following camping trip or season. To prevent costly freeze-ups, winterize the plumbing system when it will not be in use for an extended period of time, especially if it is stored in colder climates.

Periodically inspect your RV for damage during storage, and seal off any area that can offer an entry point for rodents, birds or insects. **Damage from birds, rodents, insect, etc., is not covered under the “Towable Limited Warranty” applicable to your RV.**

When storing your RV, it is recommended that the auxiliary battery (customer supplied) be disconnected to avoid battery discharge.

Prior to Storage

If storing for the winter, be sure the RV is winterized (refer to *Sec. 8 Plumbing System, Winterizing the plumbing system*).

- Check your roof and other surfaces to ensure there is no damage and potential leakage that might otherwise go unnoticed until it is too late.
- Close all windows and roof vents.
- Close the propane cylinder valve(s). If you do not have a propane cylinder cover, we recommend purchasing one to make sure the regulator is covered.
- Cover all external outlets, such as furnace, exhaust, etc. to prevent mice or other rodents from entering.
- Cover the roof air conditioner (if so equipped).
- Disconnect 120-volt AC power to the RV.
- Do not use the stabilizing jacks during storage.
- Drain all water lines.
- Drain and flush all holding tanks (fresh water, gray water, black water and/or hot water tanks).
- Remove all batteries from the RV and store in a place where they won't freeze. Batteries that have been frozen will never hold a proper charge.
- Store your RV indoors, under a roof or purchase a “breathable” cover for use during storage.

SECTION 14: TRAVEL/CAMPING/STORAGE CHECKLISTS

- Thoroughly wash the interior and the exterior of your RV.
- To prevent weather checking and other UV damage, cover tires that are exposed to sunlight.
- Turn all cushions on edge to prevent the moisture/mildew buildup during storage.
- Turn off 12-volt DC/120-volt AC/propane to the refrigerator; defrost and clean (if so equipped). Prop (or block) the doors open so air can circulate and prevent mildew or use crumpled newspaper or open boxes of baking soda in the refrigerator to eliminate odors during storage.
- Remove all perishables from the cabinets. Leave the cabinets and doors ajar to allow air circulation and prevent mildew and musty odors.
- Remove all perishables from the cabinets. Leave the cabinets and doors ajar to allow air circulation and prevent mildew and musty odors.
- Lubricate locks and hinges on exterior doors.

During Storage Period

Remove snow from the top of your RV to prevent damage to the unit's structure.



CAUTION

Excessive snow, 8" or more, or ice, 2" or more, places excessive weight on the RV roof. Remove excessive snow or ice as needed. Care **MUST** be exercised to not damage the roof material when removing snow & ice. Excessive weight can damage the roof, seals, etc. Water leaks and poor fit or operation are the results of this damage.

FEATURED COMPONENTS QUICK REFERENCE CHART

Your recreation vehicle may be equipped with some of the items listed below. This is a partial listing and it is not intended to cover all components. All information is the latest available at the time of publication. Jayco reserves the right to change any of the following information without notice.

COMPONENT	MANUFACTURER	WEBSITE
Air Conditioner	RV Products	www.rvcomfort.com
Awning	Carefree of Colorado	www.carefreeofcolorado.com
Axle	Lippert Components	www.lci1.com
DVD/CD	See manufacturers' user guide	
Entrance Step	Lippert Components	www.lci1.com
Fan, Exhaust 12V	Ventline	www.ventline.com
Fire Extinguisher	See manufacturers' user guide	
Furnace	Atwood/Hydroflame	www.atwoodmobile.com
Microwave	See manufacturers' user guide	
Monitor Panel	KIB Enterprises	www.kib.us
Outside Shower / Utility Center	B & B Molders	www.bandbmolders.com
Propane Tank	Manchester Tank	www.mantank.com
Propane/Carbon Monoxide Alarm	See manufacturers' user guide	
Propane Regulator	Dehco	www.dehco.com
Range/stove/cooktop	Atwood	www.atwoodmobile.com
	Suburban	www.suburban_manufacturing.com
	Dehco	www.dehco.com
Range hood	Ventline Inc.	www.ventline.com
Refrigerator	Norcold	www.norcold.com
	Frigidaire	www.frigidaire.com
	Dometic	www.dometic.com
	Pummel Drive	website not available
	GE	www.ge.com
Smoke Alarm	See manufacturers' user guide	
Tank Sprayer/BLK	B & B Molders	www.bandbmolders.com
Thermostat	RV Products	www.rvcomfort.com
Toilet	Thetford Corp.	www.thetford.com
TV	See manufacturers' user guide	

SECTION 15: ADDITIONAL INFORMATION

TV Antenna	Winegard Company	www.winegard.com
Water Heater, Tank DSI	Atwood Greenbrier	www.atwoodmobile.com
Water Heater, Tankless	Girard Systems	www.greenrvproducts.com
Water Pump, 12V	Shurflo East	www.shurflo.com

SECTION 15: ADDITIONAL INFORMATION

**Jayco
Ownership Notification
Fax Form To: (800) 825-7876**

ATTENTION!

Federal record keeping laws require that we maintain a file of owners of our product. Your cooperation in filling out this form will be appreciated.

Change of Owner

Transfer of Limited Warranty
(see limited warranty for details)

Model Information:

Serial#: _____

Chassis #: _____ Odometer Reading _____

(Motorized only)

New Owner Information:

Purchased Date: _____

Name: _____

Address: _____

City: _____ State/Province: _____ Zip Code _____

Phone # _____ E-Mail Address _____

Previous Owner Information:

Purchased Date: _____

Name: _____

Address: _____

City: _____ State/Province: _____ Zip Code _____

Phone # _____ E-Mail Address _____

SECTION 15: ADDITIONAL INFORMATION

Notes:

Notes: