



Jayco® Generations of family fun.

2017



TOWABLES

OWNER'S MANUAL



eco advantage™

THE ENEGRA ECOADVANTAGE IS OUR COMPANY'S COMMITMENT TO PROTECTING THE ENVIRONMENT. Through Entegra's company-wide sustainability program, we're creating better ways to build better RV's using fewer natural resources. Already, our initiative has created significant impact. As of 2014 our company has:

Recycled



- 7,192 tons of wood
- 2,354 tons of scrap metal
- 1,428 tons of cardboard and paper

Conserved



- 9,997,400 gallons of fresh water, enough to meet the daily needs of 133,293 Americans.
- 34,277 gallons of gas, enough for Americans to drive more than 957,600 miles.
- Enough electricity to power 1,745 homes for the year.

Saved



- 60,900 mature trees.
- Enough landfill airspace to meet the annual disposal needs of a community of 44,683 people.

We're proud of our results, and we know those numbers show that a little initiative can go a long way. The Entegra EcoAdvantage is our way of making sure endless generations can enjoy the Great Outdoors.

TABLE OF CONTENTS

SECTION 1: WARRANTY & SERVICE

About This Manual	3
Warranty packet	3
Safety Alerts	3
Reporting Safety Defects	4
Manufacturing Process	5
Options & Equipment	5
Customer Responsibility	5
Change Of Address/Ownership	6
Dealer Responsibility	6
Suggestions For Obtaining Service	6
Customer Relations	7
Jayco Travel Club	8
JayPlus™ Extended Service Contract	8
Jayco Customer First Emergency Roadside Assistance	8
Obtaining Emergency Warranty Repair	9
Obtaining Service For Separately Warranted Items	10
Obtaining Service at Jayco	10
Parts & Accessories	10
Notice To Jayco Dealers	15

SECTION 2: OCCUPANT SAFETY

Secondary Means of Escape (Exit Window)	21
<i>Exit window Label</i>	21
Fire Safety	22
Fire Extinguisher	22
Smoke Alarm	23
Combination Carbon Monoxide/ Propane Alarm	25
<i>(alarm may vary from model shown above)</i>	25
<i>LP/Carbon monoxide detector</i>	25
Formaldehyde	28
Extended Or Full Time Usage	28
Cold Weather Usage	28
Condensation	29

SECTION 3: PRE-TRAVEL INFORMATION

Tow Vehicle	31
Vehicle Labels	31
<i>OCCC Label (yellow)</i>	32
<i>Federal Certification Label</i>	32
<i>Tire & Loading Information</i>	32
Loading Your Recreation Vehicle	33
Cargo Carrying Accessory Receiver (If So Equipped)	34
Rear Bumper	34
Travel Trailer Hitch (Customer Supplied)	34
Travel Trailer Hitching Procedure	35
<i>Safety chain installation</i>	37
Wire Harness/Connector Plug	38
Weighing Your Tow Vehicle & RV	38
<i>7-way trailer plug -</i>	38
<i>car end-rear view</i>	38

SECTION 4: VEHICLE OPERATIONS

Towing	41
Towing Behind Your RV	42
RV Brake System	42
Travel Trailer Breakaway Switch	43

TABLE OF CONTENTS

Entrance Door Step(s)	46
Entrance Door	46
Keys	46
Rear Backup Camera Prep	46
<i>RV Step</i>	46
Campsite Hook-Up	47
Leveling the RV	47
Stabilizer Jacks	47
Emergency Stopping	48
Emergency Towing	48
Wheel Lugs	49
Tires	51
Changing A Tire	53
Spare Tire Carrier (If So Equipped)	54
<i>Hoist mount with brackets</i>	54
<i>travel position</i>	54
<i>Hoist mount/flush mount</i>	54
<i>travel position</i>	54
<i>Bumper mount</i>	55
Travel Trailer Set Up	56
Patio Awning	56
Operating Power Awnings (If So Equipped)	57

SECTION 5: SLIDEOUT SYSTEMS

Electric Slide Room(s) (If So Equipped)	61
Slideout Systems	62
<i>Slideout overlap-outside</i>	62
<i>Fig. 1-Through Frame Crank Extension w/pin</i>	68
<i>Fig. 3-Hex Head Crank Extension</i>	68
<i>Fig. 2- Crank Handle</i>	68
<i>Fig. 4-Ratchet</i>	68
<i>Fig.1 Slideout Controller</i>	73

SECTION 6: ELECTRICAL SYSTEMS

The Electrical System	79
Command Center	79
<i>Command Center Panel</i>	80
<i>Command Center Panel</i>	80
<i>W/Switch Modules</i>	80
<i>Mounted to wall</i>	80
GFCI Receptacle	81
Testing the Campsite Power Connection	81
Connecting the Power Cord	82
12-volt DC System	84
12-volt Fuse Panel	84
12-Volt DC Outlet	85
Auxiliary Battery (Customer Supplied)	85
Battery Isolator For Your Tow Vehicle (Customer Supplied)	86
Load Center	87
Approximate Electrical Load Ratings	87
<i>Typical Load Center Exterior Panel</i>	87
120-volt (30 AMP) AC System (If So Equipped)	88
30-amp Power Cord (If So Equipped)	89
Calculating 30 AMP Electrical Load (If So Equipped)	89

TABLE OF CONTENTS

Calculating 50 AMP Electrical Load (If So Equipped)	90
120-volt Circuit Breakers	90
Solar Prep (If So Equipped)	91
<i>Solar Plug</i>	91
Replacing Light Bulbs	92
SECTION 7: FUEL & PROPANE SYSTEMS	
<hr/>	
Exhaust Gas Fumes	93
Propane Gas System	93
Propane Leak Test	94
Propane Safety Procedure	94
Propane Gas Container	95
<i>Propane system label</i>	95
<i>“Use propane only” label (Canada only)</i>	96
<i>(Label appearance may not be exact)</i>	96
<i>“Shut off for re-fueling” label</i>	97
<i>(Label appearance may not be exact)</i>	97
Installing Propane Cylinder(s)	98
<i>Single Cylinder</i>	98
<i>“Do not fill to more than 80%” label</i>	98
<i>(Label appearance may not be exact)</i>	98
<i>Double Cylinder</i>	99
Propane Regulator	100
Using The Propane System	101
Calculating Propane Gas Usage	101
Cooking With Propane Gas	102
<i>Ensure a supply of fresh air (Canada units only)</i>	102
Traveling with Propane	103
<i>Cooking / comfort heating label</i>	103
<i>Re-fueling Warning Label</i>	103
SECTION 8: PLUMBING SYSTEM	
<hr/>	
Plumbing System Maintenance	105
Monitor Panel (If So Equipped)	105
<i>(Monitor panel appearance and components listed may vary)</i>	105
<i>Monitor Panel</i>	105
<i>Command Center Panel</i>	105
Fresh Water System	106
Fresh Water Holding Tank	107
12-Volt Water Pump & Switch	107
Water Pressure Regulator (customer Supplied)	108
<i>Water pump</i>	108
Fresh Water Connections	109
<i>City Water Fill with City water connection label</i>	109
<i>Potable Water Label</i>	110
<i>Gravity Water Fill</i>	110
Water Heater	111
<i>Anode rod replacement chart</i>	112
<i>Water Heater Pilot ignition</i>	112
Water Heater Bypass – 3 Valves (If So Equipped)	114
Outside Shower (If So Equipped)	115
<i>Factory installed</i>	115
<i>3-valve water heater bypass</i>	115
Faucets	116
Bathroom Tub / Shower	116

TABLE OF CONTENTS

Hardware & Sink or Shower Fixtures	117
Draining The Fresh Water System	117
<i>Low point drains</i>	117
<i>Exterior fresh water drain</i>	117
Sanitizing the Plumbing System	118
Winterizing The Plumbing System	120
<i>Water heater drain plug location</i>	122
<i>Blowout plug</i>	122
<i>Exterior fresh water drain</i>	123
Black/Grey Water System	125
Black/Grey Water Holding Tanks	126
Black & Grey Tank Drains	127
<i>Black/Grey tank drain & valves</i>	127
Black Tank Flush	128
Toilet	128
<i>Tank Flush Inlet</i>	128

SECTION 9: HEATING & COOLING

Air Conditioner	131
Power Roof Vent (If So Equipped)	131
<i>Attic Fan Control</i>	131
Ducting & Return Air	132
Furnace	132

SECTION 10: APPLIANCES

Microwave	133
Cooktops (If So Equipped)	133
Kitchen Range & Oven (If So Equipped)	135
Gas BBQ Grill (If So Equipped)	136
<i>Bumper mounting bracket</i>	137
Range Hood (If So Equipped)	138
<i>Gas Grill & Mounting</i>	138
<i>Quick Coupler Connection</i>	138
<i>Bracket on Support Rail</i>	138
<i>Range Hood Vent</i>	138
Cooking With Propane	139
In Case Of A Grease Fire	139
Refrigerator	139
Cleaning Your Refrigerator	140
Washer/Dryer Prep (If So Equipped)	141
Water Heater – See plumbing section	141
Outside Kitchen (If So Equipped)	141
<i>Wood Support</i>	142
<i>Locking Lever</i>	142
<i>Quick connect coupler</i>	144

SECTION 11: ELECTRONICS

Satellite (if so equipped)	145
HDTV Antenna (If So Equipped)	145
<i>King Jack HDTV antenna</i>	145
<i>Winegard HDTV antenna</i>	145
<i>Enclosure base</i>	145
<i>Interior base</i>	145
Television Roof Antenna (if so equipped)	146
Television Power Supply (If So Equipped)	147
<i>TV Power Supply</i>	147

TABLE OF CONTENTS

SECTION 12: INTERIOR

Cleaning The Interior	149
Décor Items	149
Sofa	150
Free-Standing Table & Chairs (If So Equipped)	151
Booth Dinette (If So Equipped)	151
1. <i>Remove tri-fold sofa pillows and set aside</i>	151
3. <i>While sleeping surface is up, gold out legs. Extend sleeping surface until grounded.</i>	151
2. <i>Using the strap handle, pull sleeping surface up, then out.</i>	151
4. <i>Once sleeping surface is grounded, fold headboard down flat.</i>	151
Cabinetry & Tables	152
Pantry or Hutch (If So Equipped)	152
Countertops	152
Interior Wall Panel	153
Flooring	153
Murphy Bed (If So Equipped)	154
<i>Stored position</i>	154
<i>Sleeping position</i>	154
ABS Plastics	157

SECTION 13: EXTERIOR

Cleaning The Exterior	159
Frame	161
E-Z Lube or Super-Lube Axle (If So Equipped)	161
Exterior Roof & Sidewall Vents	162
Windows	162
Exterior ladder (If So Equipped)	162
Sealants	162
Travel Trailers - Sealant Diagram	163

SECTION 14: TRAVEL/CAMPING/STORAGE CHECKLISTS

RV Start-Up	165
Ready To Leave & Maintenance Checklist	165
RV Storage	167

SECTION 15: ADDITIONAL INFORMATION

Featured Components Quick Reference Chart	169
---	-----



WARNING: READ ALL INSTRUCTIONS IN THIS MANUAL AND COMPONENT MANUFACTURER SUPPLIED INFORMATION BEFORE USING YOUR RV.

This manual has been provided by Jayco for the sole purpose of providing instructions concerning the operation and maintenance of this vehicle and its components. Nothing in this manual creates any warranty, either expressed or implied. The only warranty offered by Jayco is as set forth in the limited warranty applicable to this vehicle.

The owner's failure to provide required service and/or maintenance could result in the loss of warranty. The owner should review the Jayco limited warranty and the limited warranties that apply to specific components that are offered with this vehicle.

Instructions are included in the manual for operating various components which are optional on some vehicles or may not be available on your particular model. **“If so equipped” does not indicate or imply that the component(s) or option(s) were at any time available, or can be retrofitted to your model.** In addition, the owner should refer to individual manufacturer's operating instructions contained in the owner's packet.

Congratulations! Thank you for selecting a Jayco recreation vehicle. We are excited to welcome you to our growing RV family. Jayco is the largest privately held manufacturer of recreation vehicles in the world. We are committed to being the most respected name in RVs. We invite you to drop by our Visitors Center located in Middlebury, Indiana. To book a group tour or check our scheduled factory tour times (free admission, closed holidays) please call 1-800-RV-JAYCO.

ABOUT THIS MANUAL

This manual is a guide to operation of the features, equipment and controls in your recreation vehicle. If you find components vary significantly from what is described, please contact your dealer to ensure you have the correct information. Nothing in this manual creates any warranty, either expressed or implied.

This Owner's Manual and Warranty Packet are to be considered permanent components of the vehicle. Keep them in your recreation vehicle at all times for personal reference. If the recreation vehicle is sold, they should remain with the vehicle for the next owner. Nothing in this manual creates any warranty, either expressed or implied, nor does it cover every possible detail of equipment, standard or option, installed on or in your recreation vehicle.

Information, illustrations and specifications in this manual reflect the most current available at the time of publication approval, are subject to change and not intended to indicate actual size.

WARRANTY PACKET

There are components that are excluded from the vehicle warranty, or are warranted separately by their own individual manufacturer's limited warranty. The Warranty Packet contains these component manufacturer supplied manuals or information sheets, warranty cards and/or registrations. Consult this information for questions regarding operating, maintenance, servicing instructions and warranty coverage. It is important you complete and mail warranty cards and registrations within the prescribed time limits to avoid loss of warranty coverage.

SAFETY ALERTS

Throughout this manual, certain items are labeled **NOTE**, **CAUTION**, **WARNING**, and **DANGER**. These terms will alert you to precautions that can involve risk to your vehicle or to your personal safety.

Read and follow them carefully. National Safety Associations and organizations require many of the instructions listed. Always use the appropriate safety gear when servicing or maintaining your recreation vehicle. Please call your dealer or our customer service representatives if you are unsure how to proceed.

These signal words indicate precautions and potential situations, which if not avoided, may result in personal injury, property damage, or damage to your recreation vehicle. These precautions are listed in the appropriate areas in this Owner's Manual, and in the information contained in the Warranty Packet, and on safety labels affixed to your recreation vehicle. Read and follow them carefully.



This is the safety alert symbol. It is used to alert you to potential personal injury hazards. Obey all safety messages that follow this symbol to avoid possible injury or death.

SECTION 1: WARRANTY & SERVICE



NOTE: Gives helpful information.

NOTICE

Indicates a potential situation that, if not avoided, may result in property damage or damage to your motor home.

CAUTION

Indicates a potentially hazardous situation that, if not avoided, may result in minor or moderate injury. It may also be used to alert against unsafe practices.

WARNING

Indicates a potentially hazardous situation that, if not avoided, may result in death or serious injury.

DANGER

Indicates an imminently hazardous situation that, if not avoided, will result in death or serious injury. This alert information is limited to the most extreme situations.

REPORTING SAFETY DEFECTS

In the United States

If you believe that your recreation vehicle has an alleged defect that could cause a crash or cause injury or death, you should immediately inform the National Highway Traffic Safety Administration (NHTSA) and Jayco.

If NHTSA receives similar complaints, it may open an investigation, and if it finds that a safety defect exists in a group of vehicles it may order a recall and remedy campaign. However, NHTSA cannot become involved in individual problems between you, your dealer or Jayco. For additional information, please refer to the NHTSA website at www.safercar.gov.

To contact NHTSA by phone:

Call the Department of Transportation (DOT) Vehicle Safety Hotline at 1-888- 327-4236 and a NHTSA representative will record your complaint information (TTY: 1-800-424-9153 or 1-202-484-5238).

To contact NHTSA by mail:

Office of Defects Investigations/CRD
NVS-216
1200 New Jersey Ave SE
Washington, DC 20590

In Canada

If you believe your recreation vehicle has an alleged safety defect, you should contact Transport Canada and Jayco. Transport Canada prefers to be called instead of posted mail or email as it enables their investigators to confirm that your information is correct, and to answer your questions accurately. For additional information, please refer to the Transport Canada website at www.tc.gc.ca.

To contact Transport Canada by phone:

Call 1-800-333-0510 (or 1-613-993-9851 if you are calling from the Ottawa region) and ask to speak to a defect investigator.

To contact Transport Canada by mail:

Road Safety and Motor Vehicle
Regulation Directorate
Transport Canada
Tower C, Place de Ville
330 Sparks Street
Ottawa, Ontario K1A 0N5

MANUFACTURING PROCESS



Jayco recreation vehicles are manufactured for use as temporary living quarters for recreation, camping and travel uses, all as defined by the bylaws of the Recreation Vehicle Industry Association (RVIA).

This recreation vehicle is not intended for use as a full-time residence or for commercial use. Commercial use means using the recreation vehicle as a business asset such as a mobile office or using the recreation vehicle for lease or rental purposes.

Jayco reserves the right to discontinue or change specifications or design at any time without notice and without incurring any obligation whatsoever. Recreation vehicles built for sale in Canada may differ to conform to Canadian Codes.

OPTIONS & EQUIPMENT

Jayco recreation vehicles are available in several sizes and models, so accessories and components may differ slightly between models. Some equipment described in this manual may not apply to your recreation vehicle.

Jayco reserves the right to discontinue or change specifications or design at any time without notice, and to make additions or improvements without incurring any obligations upon itself to install these changes on its products previously manufactured. Recreation vehicles built for sale in Canada may differ to conform to Canadian Codes.

CUSTOMER RESPONSIBILITY

It is important you read and understand all instructions and precautions before operating the recreation vehicle. Even if you are an experienced RV'er we encourage you to thoroughly read this Owner's Manual, as well as the information contained in your Warranty Packet.

SECTION 1: WARRANTY & SERVICE

As technology advances, new improvements enter the RV industry every day, and each RV manufacturer has its own unique manufacturing process.

Familiarize yourself with the applicable warranties. There are components that are excluded or warranted separately by their individual manufacturer's limited warranty (refer to the Warranty Packet).

As the owner of the recreation vehicle, you are responsible for regular and proper maintenance performed in accordance with this manual and the OEM manuals. Regular and proper maintenance will help prevent conditions arising from neglect that are not covered by warranty. It is your responsibility and obligation to return your recreation vehicle to your dealer for warranty service repair.

CHANGE OF ADDRESS/OWNERSHIP

Please notify Jayco Customer Service as soon as possible of a change of address by writing or calling us. For notification of a change of ownership, please fill out the appropriate form located in this manual and mail it to Jayco Customer Service along with documentation showing proof of ownership. Please include your current vehicle mileage (motorized only).

DEALER RESPONSIBILITY

At the time of sale of the new recreation vehicle, your Jayco dealer is expected to:

Deliver your recreation vehicle in the best condition possible. Your recreation vehicle must pass the dealer's pre-delivery inspection (PDI), including all systems tests.

Provide orientation of the recreation vehicle, its systems, components and operation.

Request that you read all warranty information and explain any provision not clearly understood.

Ensure you receive the Warranty Packet. Your dealer can assist you in completing the OEM warranty cards or registrations, and locate any required component model or serial numbers.

Complete and return the "Warranty Registration and Customer Delivery Form" to Jayco within 10 days of delivery to activate the applicable warranty coverage.

The **Limited Warranty** is activated only after Jayco receives a signed and dated "Warranty Registration and Customer Delivery Form" from your dealer.

SUGGESTIONS FOR OBTAINING SERVICE

To help ensure your dealer provides the level of service you expect, here are some suggestions we would like to make:

Contact your dealer at once... Do not wait until you are ready to use your RV. Your dealer may not be able to service it immediately and/or the repair may require parts be ordered. The dealer's service department is busiest on Mondays, Fridays and before the holidays.

Prepare for the appointment... If you are having warranty work performed, be sure to have the right papers with you. Take your warranty folder and have your vehicle information available. All work to be performed may not be covered by the warranty. Discuss additional charges with the service personnel.

Prepare a list... Provide your dealer with a written list of specific repairs needed. It is important that you provide any vehicle repair history to the dealer's service personnel.

Keep a maintenance log of your vehicle's service history. This can often provide a clue to the current issue.

Be reasonable with your requests... If you leave a list with several items and you need your vehicle returned back by a specific time, discuss the situation with the dealer's service personnel and list your items in order of priority. This may include making a second appointment for work not completed or parts that the dealer may need to order.

Don't expect to look over the technician's shoulder... Please don't be offended if you are told you cannot watch the work being done. Some insurance requirements forbid admission of customers to the service area.

Inspect the work performed... Finally, check out the service or repair job when you pick up your vehicle. Notify the dealer's service personnel immediately of any dissatisfaction. If you cannot return the vehicle immediately for repair, make an appointment as soon as possible.

Please be aware that all service shops require notification of any issues with their repairs within a specified time limit. Make sure you are familiar with their repair policies.

CUSTOMER RELATIONS

Jayco has empowered its dealers to make warranty and repair decisions.

If a special circumstance occurs that requires information from Jayco, we have asked your dealer's service management to make the contact on your behalf. **This is why you should always talk to your dealer's service management first.**



NOTE: Please provide the following information when contacting us for assistance:

Customer name and current location.

Phone number where you can be reached.

17-digit chassis Vehicle Identification Number (VIN) or 9-digit Serial

The current vehicle mileage (motor homes)

Your date of purchase.

If applicable, the component description, serial number and model number.

A detailed description of the concern.

The name of your selling dealer.

If different from above, the contact information for the RV repair facility you are contacting Jayco to discuss.

Mailing address

Jayco, Inc.
Customer Service
P.O. Box 460
903 S. Main Street
Middlebury IN 46540

Shipping address

Jayco, Inc.
Customer Service
100 Bontrager Drive
Bldg 42 Door 4220
Middlebury IN 46540

SECTION 1: WARRANTY & SERVICE

Phone (toll-free)	(800) 283-8267
Phone (local)	(574) 825-0608
Fax (toll-free)	(866) 709-9139
Brochure request	info@Jayco.com
Parts email	parts@Jayco.com
Service email	service@Jayco.com
Website	www.Jayco.com

An important note about alterations and warranties

Installations or alterations to the original equipment vehicle as distributed by Jayco are not covered by the Jayco Limited Warranty. The special body company, assembler, equipment installer or up fitter is solely responsible for warranties on the body or equipment and any alterations (or any effect of the alterations) to any of the parts, components, systems or assemblies installed by Jayco. Jayco is not responsible for the safety or quality of design features, materials or workmanship of any alterations by such suppliers.

JAYCO TRAVEL CLUB

All owners of Jayco recreation vehicles are eligible for membership in the Jayco Travel Club. The club promotes family camping and the active use of your RV with others who have similar interests in the RV lifestyle.



One "International Rally" is held each year in various locations around the United States and Canada. In addition, the club offers a variety of local and regional activities throughout the year.

By belonging to the Jayco Travel Club, you will find new ways to enjoy your RV and make friends all across the country.

For more information, please visit www.Jaycorvclub.com or call 1-800-262-5178.

JAYPLUS™ EXTENDED SERVICE CONTRACT

Don't let unexpected repair costs keep you from traveling toward your dreams. Protect yourself with a JayPlus™ Extended Service Agreement. For more information, contact your dealer or call 1-800-527-3426.



Your dealer can help you obtain a JayPlus™ insurance quote from GMAC Insurance or call 1-877-484-2261 (Savings Code: GL 2A).

JAYCO CUSTOMER FIRST EMERGENCY ROADSIDE ASSISTANCE

Jayco has teamed up with Coach Net, the largest RV emergency road service in the country to give you 24 hour, 7 days a week assistance in obtaining dependable service when and where you need it. We are offering this free of charge for the first year of ownership from the date of purchase (*certain restrictions apply**).

You may continue your Customer First Roadside Assistance benefits in the following years by contacting Coach Net to discuss any applicable terms and rates for this independently continued coverage at 1-877-801-0333.

SECTION 1: WARRANTY & SERVICE

For further details and instructions on how to access your Roadside Assistance benefits, please refer to your *Member Benefit Guide* which will be mailed 6-8 weeks from the date the completed *Warranty Registration and Customer Delivery Form* is received by Jayco, or by contacting Coach-Net (www.coach-net.com) at 1-877-801-0333.

**To qualify for coverage, your RV must be eligible as set forth under the terms of the applicable "Limited Warranty" offered by Jayco.*

OBTAINING EMERGENCY WARRANTY REPAIR

A roadside emergency can happen at any time, whether your recreation vehicle is new or old. If you are traveling, using the following guidelines can help get you back on the road faster.

1. Call 1-800-RV-JAYCO or use our website dealer locator to find an authorized Jayco dealer in your area. Contact them for an appointment; they will handle all warranty repair billing and returned parts for you.
2. If you cannot locate an authorized Jayco dealer near you, ask the campground staff for referrals or check the local telephone yellow pages. Or contact Jayco Customer Service or your selling dealer for assistance in locating a repair facility.
 - c. Contact the RV repair facility to discuss your situation and make an appointment. Ask how their billing will be handled. They may choose to bill Jayco directly; otherwise, you are expected to pay them.
 - d. Have the RV repair facility inspect your RV. Either they or you must call Jayco Customer Service to discuss applicable warranty coverage prior to any repair work being performed.
 - e. Jayco Customer Service will issue an authorization number upon warranty repair approval and advise if any original parts need to be returned.
 - f. Once Jayco Customer Service has issued an authorization number, the RV repair facility may begin actual repair to your RV.
 - g. Inspect the completed repair work thoroughly. If you are not satisfied, communicate that immediately to the RV repair facility management. Make sure you are satisfied with the repair before you pay or leave the premises.
 - h. For reimbursement, either you or the RV repair facility must send a copy of your itemized repair bill and all requested return parts by UPS (regular ground, freight pre-paid) within 60 days of the completed repair date.

To expedite processing your warranty claim, include your name, address, phone number, RV 17-digit VIN and authorization number. If returning parts, include a copy of your return freight bill.

Obtaining weekend or after business hours repair assistance

If an authorized Jayco dealer is not located nearby, contact your selling dealer for assistance. If your dealer is closed, check with the campground staff or telephone yellow pages for an RV repair facility. Have the item repaired and contact Jayco Customer Service immediately the following business day.

Failure to contact Jayco Customer Service, unauthorized or improper warranty repairs, or failure to return requested original parts may result in loss of reimbursements and/or loss of warranty.

SECTION 1: WARRANTY & SERVICE

OBTAINING SERVICE FOR SEPARATELY WARRANTED ITEMS

Your selling dealer is responsible for servicing your recreation vehicle before delivery, and has an interest in your continued satisfaction. We recommend your dealer perform all inspection, warranty and maintenance services. Some dealers may be authorized service centers for those OEMs whose products are warranted separately and excluded from the **Limited Warranty**.

OBTAINING SERVICE AT JAYCO

Should your RV be in need of service, and your dealer recommend that the repairs be made at the Jayco Factory Service Center, your RV may be returned to us with the following guidelines*:

- You or your dealer must make a confirmed appointment a minimum of 60 days prior to dropping off your RV at the Jayco Factory Service Center.
- The holding tanks must be emptied and rinsed. We have a dumping station available for customer use.
- The propane system and all electrical systems must be shut down and turned off. We are not responsible for discharged batteries or propane tanks.
- During the appropriate season, please ensure your RV is winterized.
- Unless prior approval has been obtained from the Jayco Factory Service Center, all personal items must be removed from the area where you are requesting service repair and the refrigerator emptied. We are not responsible for loss of food items.
- All transportation costs are the responsibility of the owner. You may need to arrange for alternative accommodations for some types of repairs. Please be prepared accordingly
- *Jayco Customer Service occasionally utilizes local independent repair facilities. Your RV may be referred to or repaired by one of these local repair facilities.*

PARTS & ACCESSORIES

Contact your independent Jayco dealer for assistance in obtaining replacement parts or accessories. Jayco does not sell parts retail direct or to non-authorized dealers. If the original part is no longer available, Jayco makes every effort to provide an appropriate substitute.

TOWABLE LIMITED WARRANTY

WHAT AND WHO IS COVERED

The Jayco warranty covers this recreational vehicle (“RV”), when used only for its intended purpose of recreational travel and camping, for two (2) years. It covers RV’s that are sold in, and remain in, the United States, U.S. Territories and Canada, only. The warranty period begins on the date that the RV is delivered to the first retail purchaser by an independent, authorized dealer of Jayco, or, if the dealer places the vehicle in service prior to retail sale, on the date the RV is first placed in such service. In the event that a substantial defect in material or workmanship, attributable to Jayco, is found to exist during the warranty period, it will be repaired or replaced, at Jayco’s option, without charge to the RV owner, in accordance with the terms, conditions and limitations of this limited warranty.

This limited warranty applies to the first consumer purchaser only. All rights and limitations within this warranty are applicable to the original owner of the RV only. Jayco’s limited warranty only covers substantial defects in materials, components, or parts of the RV attributable to Jayco. It does not replace, modify, or apply to the warranties provided by the manufacturers that supply the products used by Jayco to assemble the RV, like the frame. You may contact an independent, authorized dealer for details.

Jayco’s obligation to repair or replace defective materials or workmanship is the sole obligation of Jayco under this limited warranty. Jayco reserves the right to use new or remanufactured parts of similar quality to complete any work, and to make parts and design changes from time to time without notice to anyone. Jayco reserves the right to make changes in the design or material of its products without incurring any obligation to incorporate such changes in any product previously manufactured. Jayco makes no warranty as to the future performance of this RV, and this limited warranty is not intended to extend to the future performance of this RV, or any of its materials, components or parts. In addition, the RV owner’s obligation to notify Jayco, or one of its independent, authorized dealers, of a claimed defect does not modify any obligation placed on the RV owner to contact Jayco directly when attempting to pursue remedies under state or federal law.

LIMITATIONS, EXCLUSIONS AND DISCLAIMER OF IMPLIED WARRANTIES

ANY IMPLIED WARRANTY THAT IS FOUND TO ARISE BY WAY OF STATE OR FEDERAL LAW, INCLUDING ANY IMPLIED WARRANTY OF MERCHANTABILITY OR ANY IMPLIED WARRANTY OF FITNESS, IS LIMITED IN DURATION TO THE DURATION SET FORTH IN THIS LIMITED WARRANTY AND IS LIMITED IN SCOPE OF COVERAGE TO THE SCOPE OF COVERAGE OF THIS LIMITED WARRANTY.

Jayco makes no warranty of any nature beyond that contained in this limited warranty. Jayco does not authorize any person to create any other obligation or liability for it regarding this RV, and Jayco is not responsible for any representation, promise or warranty made by any dealer or other person beyond what is expressly stated in this limited warranty, and no one has the authority to enlarge, amend or modify this limited warranty. Any selling or servicing dealer is not Jayco’s agent, but an independent entity.

JAYCO SHALL NOT BE LIABLE FOR ANY INCIDENTAL OR CONSEQUENTIAL DAMAGES THAT MAY RESULT FROM BREACH OF THIS LIMITED WARRANTY OR ANY IMPLIED WARRANTY.

SECTION 1: WARRANTY & SERVICE

THIS EXCLUSION OF CONSEQUENTIAL AND INCIDENTAL DAMAGES SHALL BE INDEPENDENT OF ANY FAILURE OF THE ESSENTIAL PURPOSE OF ANY WARRANTY, AND THIS EXCLUSION SHALL SURVIVE ANY DETERMINATION THAT THIS LIMITED WARRANTY OR ANY IMPLIED WARRANTY HAS FAILED OF ITS ESSENTIAL PURPOSE.

Some states do not allow limitations on how long an implied warranty lasts, or the exclusion or limitation of incidental or consequential damages, so the above limitations or exclusions may not apply to you.

HOW TO GET SERVICE

To obtain warranty service the owner must do all of the following:

1. Notify an independent, authorized dealer of Jayco, or Jayco, of the substantial defect in material or workmanship attributable to Jayco, within the warranty coverage period designated above;
2. Provide the notification mentioned in (1), above, within ten (10) days of when the owner discovered, or should have discovered, the substantial defect in material or workmanship attributable to Jayco;
3. Promptly schedule an appointment with and take the RV to an independent, authorized dealer of Jayco, or Jayco, for repairs; and
4. Pay any freight or transportation costs, import duties, fees and all incidental expenses associated with obtaining warranty service.

For warranty service simply contact one of Jayco's independent, authorized service centers for an appointment and then deliver your RV to the service center on the specified appointment date. If you need assistance you may contact Jayco, at 903 S. Main Street, P.O. Box 460, Middlebury, Indiana 46540, Attn: Customer Service, (574) 825-5861, (800) 283-8267 or www.jayco.com.

NOTE: Jayco does not control the scheduling of service work at the independent, authorized dealerships. You may encounter some delay in scheduling or completion of work. Also, you must notify the selling dealer at time of delivery to have work performed on any defect that occurred at the factory during manufacture at no cost to you as provided by this limited warranty. (See below under WHAT IS NOT COVERED).

If two (2) or more service attempts have been made to correct any covered defect that you believe impairs the value, use or safety of the RV, or if it has taken longer than thirty (30) days for those types of repairs to be completed, you must, to the extent permitted by law, notify Jayco directly, in writing, at the above address, of the unsuccessful repair(s) of the alleged defect(s) so that Jayco can become directly involved in making sure that you are provided service pursuant to the terms of this limited warranty.

WHAT IS NOT COVERED

By way of example only, this limited warranty does not cover any of the following: defects in materials, components or parts of the RV not attributable to Jayco; items that are added or changed after the RV leaves the possession of Jayco; additional equipment or accessories installed at any dealership, or other place of business, or by any other party, other than Jayco; any RV used for rental or other commercial purposes (Note: It shall be concluded that the RV has been used for commercial and/or business purposes if the RV owner or user files a tax form claiming any business or commercial tax benefit related to the RV, or if the RV is purchased, registered or titled in a business name); any RV sold

SECTION 1: WARRANTY & SERVICE

or used outside the United States, U.S. Territories or Canada; any RV not used solely for recreational travel and camping; any RV purchased through auction or wholesale; any RV purchased from a dealer that is not an authorized dealer of Jayco; normal wear, tear or usage, such as tears, punctures, soiling, mildew, fading, or discoloration of exterior plastic or fiberglass, or soft goods, such as upholstery, drapes, carpet, vinyl, screens, cushions, mattresses and fabrics; the effects of condensation or moisture from condensation inside the RV or failure to provide adequate ventilation; mold or any damage caused by mold to the inside or outside of the RV; imperfections that do not affect the suitability of the RV for its intended purpose of recreational use or items that are working as designed but that you are unhappy with; problems, including water leaks, related to misuse, mishandling, neglect or abuse, including failure to maintain the RV in accordance with the owner's manual, or other routine maintenance such as inspections, lubricating, adjustments, tightening of screws and fittings, tightening of lug nuts, sealing, rotating tires; damage due to accident, whether or not foreseeable, including any acts of weather or damage or corrosion due to the environment, theft, vandalism, fire, or other intervening acts not attributable to Jayco; service items such as windshield wiper blades, lubricants, fluids, filters, etc.; damage resulting from tire wear or tire failure; defacing, scratches, dents, chips on any surface or fabric of the RV; damage caused by off road use, overloading the RV or alteration of the RV, or any of its components or parts; wheel alignment or adjustments to axles when caused by improper maintenance, loading or damage from road hazards, including off road travel, wheel damage or balancing or damage from tire failures. Also, any costs associated with obtaining service, including by way of example, travel costs, are specifically excluded from the coverage of this warranty.

In addition, this limited warranty does not cover any material, component or part of the RV that is warranted by another entity, including, by way of example, handling, braking, wheel balance, muffler, tires, tubes, batteries, gauges, generator, hydraulic jacks, inverter, converter, microwave, television, DVD/CD player, radio, speakers, television, refrigerator, range, hot water heater, water pump, stove, carbon monoxide detector, smoke detector, propane detector, furnace or any air conditioner. (Note: The written warranty provided by the manufacturer of the component part is the direct responsibility of that manufacturer).

Defects and/or damage to interior and exterior surfaces, trim, upholstery and other appearance items may occur at the factory. These items are usually detected and corrected at the factory or by the selling dealer prior to delivery to the retail customer. You must inspect your RV for this type of damage when you take delivery. If you find any such defect or damage you must notify the selling dealer at time of delivery to have these items covered by this limited warranty and to have work performed on the items at no cost to you as provided by this limited warranty.

EVENTS DISCHARGING JAYCO FROM OBLIGATION UNDER WARRANTY

Certain things completely discharge Jayco from any obligation under this warranty and void it. By way of example, the following shall discharge Jayco from any express or implied warranty obligation to repair or replace any defect that results from: any rental or other commercial use or purchase of the RV (as defined in this warranty), any RV sold outside of, or used outside of, the United States, U.S. Territories or Canada, through an auction or wholesale or by a non-authorized dealer, any defect in a separately manufactured component part, owner neglect or failure to provide routine maintenance (See Owner's Manual), unauthorized alteration, off road use, collision or accident, whether or not foreseeable, including any acts of weather or damage or corrosion due to the environment, theft, vandalism, fire, explosions, overloading in excess of weight ratings, and tampering

SECTION 1: WARRANTY & SERVICE

with any portion of the RV, or any use of the RV as a semi-permanent or permanent home.

LEGAL REMEDIES

Any action to enforce any portion of this limited warranty, or any implied warranty, shall be commenced within six (6) months after expiration of the warranty coverage period designated above. Any performance of repairs shall not suspend this limitation period from expiring. Any performance of repairs after the warranty coverage period has expired, or performance of repairs regarding anything excluded from coverage under this limited warranty shall be considered “good will” repairs, and they will not alter the express terms of this limited warranty, or extend the warranty coverage period or this limitation period. In addition, this warranty is not intended to extend to future performance, and nothing in this warranty, or any action of Jayco, or any agent of Jayco, shall be interpreted as an extension of the warranty period or this limitation period. Some states do not allow a reduction in the statute of limitations, so this reduction may not apply to you.

WARRANTY REGISTRATIONS

Your warranty registration records should be completed and delivered to the manufacturers of component parts. The selling dealership will assist you in completing and submitting the Jayco product warranty registration form. That form must be returned to Jayco within ten (10) days of your taking delivery of the RV. Your Jayco warranty will not be registered unless this warranty registration is completed and received by Jayco. Failure to file this warranty registration with Jayco will not affect your rights under this limited warranty as long as you can present proof of purchase, but it can cause delays in obtaining the benefits of this limited warranty, and it may inhibit any servicing facility’s ability to provide proper repairs and/or part replacement.

CARE AND MAINTENANCE

It is the owner’s responsibility to perform proper care and maintenance of the RV, and to assure correct load distribution. For details regarding this, please see your Jayco owner’s manual and the owner’s manuals of the chassis manufacturer and other component part manufacturers. These outline various care and maintenance that is required to maintain your RV. Please review all manuals supplied with your RV, and contact your selling dealership or supplier of the component part if you have questions. Note: Failure to maintain the RV as noted in those manuals voids this limited warranty, and any damage to the RV as a result of your failure to perform such care, is not covered by this limited warranty.

THIS WARRANTY GIVES YOU SPECIFIC LEGAL RIGHTS, AND YOU MAY ALSO HAVE OTHER RIGHTS THAT VARY FROM STATE TO STATE.

JAYCO, INC.

903 S. Main Street * P.O. Box 460 * Middlebury, IN 46540

Telephone: 574-825-5861 or 800-283-8267

NOTICE TO JAYCO DEALERS

This Owner's Manual contains the *Towable Limited Warranty* that applies to this RV. However, if the Jayco dealer decides to use this RV for rental purposes, then the *Towable Limited Warranty* will not apply to this RV. The *Towable Limited **Rental** Warranty* applies in that situation.

If, on the other hand, the Jayco dealer sells this RV to a retail customer then the rental warranty would not be applicable. **The rental warranty does not apply to retail consumers.**

Jayco's rental program is applicable to the following product lines:

- Jay Sport Camping Trailers
- Jay Feather Hummingbird TT
- Jay Feather Travel Trailers
- Jay Feather 7 Travel Trailers
- White Hawk Travel Trailers
- Jay Flight Travel Trailers
- Jay Flight SLX Travel Trailers
- Jay Flight Bungalow Travel Trailers
- Eagle Travel Trailers
- Eagle Fifth Wheels
- Eagle HT Fifth Wheels
- Eagle HT Travel Trailer
- Designer FW
- North Point FW
- Pinnacle Fifth Wheels
- Octane Toy Haulers
- Seismic Fifth Wheel Toy Haulers
- Seismic Wave Fifth Wheel Toy Haulers

If you have any questions regarding this, please contact Jayco Customer Service at (800) 283-8267 or (574) 825-0608.

JAYCO TOWABLE RENTAL LIMITED WARRANTY

WHAT AND WHO IS COVERED

The Jayco warranty covers this recreational vehicle (“RV”), when used only for recreational travel and camping, including recreational travel and camping by renters of the Dealer, for one (1) year. This limited warranty applies to the original Dealer only, and it is not transferable. The warranty period begins on the date that Dealer first places the RV in rental service. In the event that a substantial defect in material or workmanship, attributable to Jayco, is found to exist during the warranty period, Jayco will reimburse the Dealer either the reasonable costs of repair or the reasonable costs of replacement of the defect, (Jayco’s option), in accordance with the terms, conditions and limitations of this limited warranty.

Jayco’s obligation to reimburse Dealer for the reasonable costs of repair or replacement of defective materials or workmanship is the sole obligation of Jayco under this limited warranty. Jayco reserves the right to use new or remanufactured parts of similar quality to complete any work, and to make parts and design changes from time to time without notice to anyone. Jayco reserves the right to make changes in the design or material or its products without incurring any obligation to incorporate such changes in any product previously manufactured. Jayco makes no warranty as to the future performance of this RV, and this limited warranty is not intended to extend to the future performance of this RV, or any of its materials, components or parts. In addition, the Dealer’s obligation to notify Jayco, of a claimed defect does not modify any obligation placed on the Dealer to contact Jayco directly when attempting to pursue remedies under state or federal law.

LIMITATIONS, EXCLUSIONS AND DISCLAIMER OF IMPLIED WARRANTIES

ANY IMPLIED WARRANTY THAT IS FOUND TO ARISE BY WAY OF STATE OR FEDERAL LAW, INCLUDING ANY IMPLIED WARRANTY OF MERCHANTABILITY OR ANY IMPLIED WARRANTY OF FITNESS, IS LIMITED IN DURATION TO THE DURATION OF THIS LIMITED WARRANTY AND IS LIMITED IN SCOPE OF COVERAGE TO THE SCOPE OF COVERAGE OF THIS LIMITED WARRANTY.

Jayco makes no warranty of any nature beyond that contained in this limited warranty. Jayco does not authorize any person to create any other obligation or liability for it regarding this RV, and Jayco is not responsible for representation, promise or warranty made by any dealer or other person beyond what is expressly stated in this limited warranty, and no one has the authority to enlarge, amend or modify this limited warranty. Any selling or servicing dealer is not Jayco’s agent, but an independent entity.

JAYCO SHALL NOT BE LIABLE FOR ANY INCIDENTAL OR CONSEQUENTIAL DAMAGES THAT MAY RESULT FROM BREACH OF THIS LIMITED WARRANTY OR ANY IMPLIED WARRANTY. THIS EXCLUSION OF CONSEQUENTIAL AND INCIDENTAL DAMAGES SHALL BE INDEPENDENT OF ANY FAILURE OF THE ESSENTIAL PURPOSE OF ANY WARRANTY, AND THIS EXCLUSION SHALL SURVIVE ANY DETERMINATION THAT THIS LIMITED WARRANTY OR ANY IMPLIED WARRANTY HAS FAILED OF ITS ESSENTIAL PURPOSE.

Some states do not allow limitations on how long an implied warranty lasts, or the exclusion or limitation of incidental or consequential damages, so the above limitations or exclusions may not apply to you.

HOW TO GET SERVICE

To obtain reimbursement of warranty service the owner must do all of the following:

Notify Jayco of the substantial defect in material or workmanship attributable to Jayco, within the warranty coverage period;

1. Provide the notification mentioned in (1), above, within ten (10) days of when the owner discovered, or should have discovered, the substantial defect in material or workmanship attributable to Jayco;
2. Promptly and appropriately make the necessary repairs; and
3. Pay any freight or transportation costs, import duties, fees and all incidental expenses associated with obtaining warranty service.

If you need assistance you may contact Jayco, at 903 S. Main Street, P. O. Box 460, Middlebury, Indiana, 46540, Attn: Customer Service (574) 825-5861, (800) 283-8267 or www.jayco.com. Also, you must notify Jayco within three (3) days of delivery to you to have work performed on any defect or damage to appearance items that occurred at the factory during manufacturer or during delivery at no cost to you as provided by this limited warranty. (See below under WHAT IS NOT COVERED).

If two (2) or more service attempts have been made to correct any covered defect that you believe impairs the value, use or safety of the RV, or if it has taken longer than thirty (30) days for those types of repairs to be completed, you must, to the extent permitted by law, notify Jayco directly, in writing, at the above address, of the unsuccessful repair(s) of the alleged defect(s) so that Jayco can become directly involved in making sure that you are provided service pursuant to the terms of this limited warranty.

WHAT IS NOT COVERED

By way of example, only, this Limited Warranty does not cover any of the following: defects in materials, components or parts of the RV not attributable to Jayco; items that are added or changed after the RV leaves the possession of Jayco; additional equipment or accessories installed at any dealership, or other place of business, or by any other party, other than Jayco; any RV not used solely for recreational travel and camping; all soft goods, normal wear, tear or usage, such as tears, punctures, soiling, mildew, fading, or discoloration of exterior plastic, fiberglass, upholstery, drapes, carpet, vinyl, screens, cushions, mattresses and fabrics; the effects of condensation or moisture from condensation inside the RV and failure to provide adequate ventilation; mold or any damage caused by mold to the inside or outside of the RV; imperfections that do not affect the suitability of the RV for its intended purpose of recreational use or items that are working as designed but that you are unhappy with; problems related to misuse, mishandling, neglect or abuse, including failure to maintain the RV in accordance with the owner's manual, or other routine maintenance such as inspections, lubricating, adjustments, tightening of screws, tightening of lug nuts, sealing, rotating tires; damage due to accident, whether or not foreseeable, including any acts of weather or damage or corrosion due to the environment, theft, vandalism, fire, or other intervening acts not attributable to Jayco; service items such as windshield wiper blades, lubricants, fluids, filters, etc.; damage resulting from tire wear or tire failure; defacing, scratches, dents, chips on any surface or fabric of the RV; damage caused by off road use, overloading the RV or alteration of the RV, or any of its components or parts.

In addition, this limited warranty does not cover any material, component or part of the RV that is warranted by another entity, including, by way of example, handling, braking,

SECTION 1: WARRANTY & SERVICE

wheel balance, muffler, tires, tubes, batteries, gauges, generator, hydraulic jacks, inverter, converter, microwave, television, DVD/CD player, radio, speakers, television, refrigerator, range, hot water heater, water pump, stove, carbon monoxide detector, smoke detector, propane detector, furnace or any air conditioner. (Note: the written warranty provided by the manufacturer of the component part is the direct responsibility of that manufacturer).

Defects and/or damage to interior and exterior surfaces, trim, upholstery and other appearance items may occur at the factory or during delivery of the RV to you. These items are usually detected and corrected at the factory. You must inspect the RV for this type of damage when you take delivery from Jayco. If you find any such defect or damage you must notify Jayco within three (3) days of delivery of the RV to you to have these items covered by this limited warranty and to have work performed on the items covered by this limited warranty.

EVENTS DISCHARGING JAYCO FROM OBLIGATION UNDER WARRANTY

Certain things completely discharge Jayco from any obligation under this warranty and void it. By way of example, the following shall discharge Jayco from any express or implied warranty obligation to repair or replace any defect that results from: any defect in a separately manufactured component part, any neglect or failure to provide routine maintenance by you or anyone you rent the RV to (See Owner's Manual), unauthorized alteration, off road use, collision or accident, whether or not foreseeable, including any acts of weather or damage or corrosion due to the environment, theft, vandalism, fire, explosions, overloading in excess of weight ratings, and tampering with any portion of the RV.

LEGAL REMEDIES

Any action to enforce any portion of this limited warranty, or any implied warranty, shall be commenced within six (6) months after expiration of the warranty coverage period designated above. Any performance of repairs shall not suspend this limitation period from expiring. Any performance of repairs after the warranty coverage period has expired, or performance of repairs regarding any thing excluded from coverage under this limited warranty shall be considered "good will" repairs, and they will not alter the express terms of this limited warranty, or extend the warranty coverage period or this limitation period. In addition, this warranty is not intended to extend to future performance, and nothing in this warranty, or any action of Jayco, or any agent of Jayco, shall be interpreted as an extension of the warranty or this limitation period. Some states do not allow a reduction in the statute of limitations, so this reduction may not apply to you.

WARRANTY REGISTRATIONS

Your warranty registration records should be completed and delivered to the manufacturers of component parts. The Jayco product warranty registration form must be returned to Jayco within ten (10) days of your taking delivery of the RV. Your Jayco warranty will not be registered unless this warranty registration is completed and received by Jayco. Failure to file this warranty registration with Jayco will not affect your rights under this limited warranty as long as you can present proof of purchase, but it can cause delays in obtaining the benefits of this limited warranty, and it may inhibit any servicing facilities' ability to provide proper repairs and/or part replacement.

CARE AND MAINTENANCE

It is your responsibility to perform proper care and maintenance of the RV, and to assure correct load distribution. For details regarding this, please see your Jayco owner's manual and other component part manufacturers. These outline various care and

SECTION 1: WARRANTY & SERVICE

maintenance that is required to maintain your RV. Please review all manuals supplied with the RV, and contact Jayco or the supplier of the component part if you have questions. Note: failure to maintain the RV as noted in those manuals voids this limited warranty, and any damage to the RV as a result of your failure to perform such care, is not covered by this limited warranty.

THIS WARRANTY GIVES YOU SPECIFIC LEGAL RIGHTS, AND YOU MAY ALSO HAVE OTHER RIGHTS THAT VARY FROM STATE TO STATE.

JAYCO, INC.

903 S. Main Street * P.O. Box 460 * Middlebury, IN 46540

Telephone: 574-825-5861 or 800-283-8267

SECTION 1: WARRANTY & SERVICE

Notes:

SECONDARY MEANS OF ESCAPE (EXIT WINDOW)

Your recreation vehicle has been equipped with a window(s) that serves as a secondary means of escape. The window(s) will allow a quick exit from the vehicle during an emergency if access to the main entrance door is not available. It is easily identified by the red latches and label.

Do not remove the following label from your recreation vehicle:



Exit window Label

When parking your recreation vehicle, make sure the egress window is not blocked by trees or other obstacles. Make sure the ground below the window is solid and can be used as an escape path.

Practice opening the window before an emergency occurs, and make sure all occupants know how to operate it:

The egress window(s) must be locked during transit.

Your recreation vehicle may be equipped with one of the following exit window styles.



Flip latch style (2 per window)

Push up on the front lip of the latch and the latch unfolds.

Push up on the front lip of the latch again to unhook the latch from the window.

When both latches are released, push out on the window which is hinged at the top. Exit the vehicle.

The screen does not need to be removed from the window.

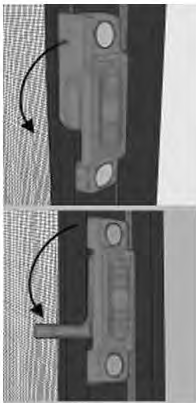

Slider window latch style

Pull the lever down to unlock the window. Slide the window to the right to open and exit the vehicle. The screen does not need to be removed from the window.

SECTION 2: OCCUPANT SAFETY

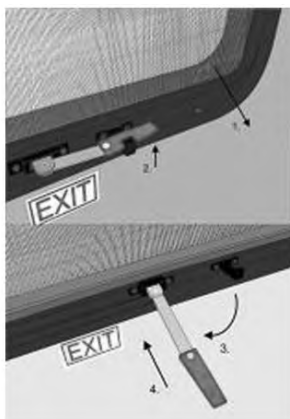

Lever style latch

Remove the screen by pulling the red tab (upper right arrow).

Pull the lever out from the sash clamps.

Swing the lever out so it is positioned straight out from the window. Push the lever (and window) out to open and exit the vehicle.

FIRE SAFETY

If a fire does start, follow these basic safety rules:

1. Have everyone evacuate the vehicle immediately.
2. After everyone is clear and accounted for, check the fire to see if you can attempt to put it out.
3. If it is large, or the fire is fuel-fed, get clear of the vehicle and have the Fire Department handle the emergency.
4. Do not attempt to use water to put out the fire. Water can spread some types of fire, and electrocution is possible with an electrical fire.

Refer to the following sections for additional fire safety information.

- Electrical Systems**, In case of an electrical fire.
- Appliances**, In case of a grease fire.

FIRE EXTINGUISHER

Fire extinguishers are classified and rated by fire type, A, B and C. These classifications identify the kinds of fires or burning materials they are designed to fight.

Class A - Solid materials such as wood, paper, cloth, rubber and some plastics.

Class B - Liquids such as grease, cooking oils, gasoline, kerosene or other flammable liquids.

Class C - Electrical such as electrical wires or other live electrical equipment.

A dry chemical fire extinguisher has been installed by the entrance door. It is suitable for extinguishing small fires of the Class B or C type only.

We suggest you become thoroughly familiar with the operating instructions displayed on the side of the fire extinguisher.



NOTE: For information on how to use your fire extinguisher, refer to the fire extinguisher user's manual provided by the fire extinguisher manufacturer.

Inspection and maintenance

Read and follow all instructions on the label and user's manual provided by the fire extinguisher manufacturer.

- Inspect the extinguisher at least once a week (more frequently if it is exposed to weather or possible tampering). This should also be done before beginning a vacation or during an extended trip.

⚠ WARNING

Do not check the pressure, test or practice using the fire extinguisher by squeezing the trigger, even briefly. The fire extinguisher is not rechargeable or refillable. Once used, it will gradually lose pressure and will not be fully charged for use in an emergency.

⚠ DANGER

Do not turn the electrical power back on or plug in any appliances after the use of a fire extinguisher. Please refer to the fire extinguisher's user manual for further instructions on maintenance and clean up.

SMOKE ALARM

The smoke alarm in your vehicle is listed for use in recreation vehicles. They only work properly if they are operational and maintained. They have a limited life and will wear out over time. Immediately replace the detector if it is not working properly, if it displays any type of problem, or within five years of use. Be sure to read, understand and follow the information provided by the smoke alarm manufacturer, including information on the limited life of smoke alarms.

Be aware the smoke alarm **is not fool proof and cannot detect fires if smoke does not reach it**. Anything preventing smoke from reaching the alarm may delay or prevent an alarm.

Though the alarm horn in this detector meets or exceeds current UL standards, it may not be heard for reasons that include (but not limited to): a closed or partially closed door, other noise from electronics, appliances or traffic.

⚠ WARNING

This smoke alarm will not alert hearing impaired residents. Special alarms with flashing strobe lights are recommended for the hearing impaired

SECTION 2: OCCUPANT SAFETY

The smoke alarm is operational once the battery is correctly installed. It will not function if the battery is missing, disconnected, dead, the wrong type or not installed correctly. **It requires one standard 9V battery.** Refer to the user's guide, for correct battery and installation information,

The LED light will indicate the battery is functioning properly. When the production of combustion is sensed, the smoke detector sounds a loud alarm that continues until the air is cleared. The LED light will also give a visual indication of a sounding alarm.

When the battery becomes weak, the alarm will “beep” about once a minute indicating a low battery. This warning should last for 30 days. You **MUST** replace the battery once the alarms low battery warning (beeping) starts to assure continued protection.

WARNING

Only use the replacement battery recommended by the smoke detector manufacturer. The smoke detector alarm may not operate properly with other batteries. Never use a rechargeable battery as it may not provide a constant charge. Never disconnect the battery to silence the alarm.

When the battery is removed from the alarm, the battery flag will pop up; the alarm cannot be installed to the mounting bracket without a battery.

To test, stand at arm's length from the smoke alarm as the alarm horn is loud and may be harmful to your hearing. The test button will accurately test all functions. Never use an open flame to test the smoke alarm.

WARNING

Test the smoke alarm operation after the vehicle has been in storage, before each trip and at least once per week during use. Do not disconnect the battery or the alarm.

Do not remove the warning label located near the smoke alarm from your recreation vehicle:

<p> WARNING</p> <p>Test smoke alarm operation after vehicle has been in storage, before each trip, and at least once per week during use. Failure to do so can result in death or serious injury.</p>
<p> AVERTISSEMENT</p> <p>VÉRIFIER LE DÉTECTEUR DE FUMÉE SI LE VÉHICULE A ÉTÉ ENTREPOSÉ, AVANT CHAQUE DÉPLACEMENT ET AU MOINS UNE FOIS PAR SEMAINE EN SERVICE.</p>

Maintenance

Vacuum off any dust on the cover of the smoke alarm using a soft brush attachment. Test the smoke alarm once you have vacuumed. Never use water, cleaners or solvents to clean the smoke alarm as they may damage the alarm. Do not paint the smoke alarm. Refer to the manufacturer's use guide for detailed maintenance information.

COMBINATION CARBON MONOXIDE/ PROPANE ALARM

Your recreation vehicle is equipped with a combination carbon monoxide (CO)/propane alarm that is listed for use in recreation vehicles. The combination carbon monoxide/propane alarm will only work if it is operational and maintained.

⚠ WARNING

The carbon monoxide detector installed is intended for use in ordinary indoor locations of recreation vehicles. It is not designed to comply with Occupational Safety and Health Administration (OSHA) commercial or industrial standards.

Do not disconnect the battery or the alarm.

Individuals with medical problems may consider using warning devices that provide audible and visual signals for carbon monoxide concentrations under 30 PPM.

This alarm will only indicate the presence of carbon monoxide gas at the sensor. Carbon monoxide gas may be present in other areas.

The ultimate responsibility for protection against toxic carbon monoxide fumes rests solely on you. Installing a carbon monoxide/propane alarm is just the first step in protecting your family from toxic carbon monoxide poisoning

The alarm is wired directly to the 12-volt electrical system, with continuous power being supplied by the recreation vehicle battery. There is no 9-volt battery power supply in the carbon monoxide/propane alarm. **If the battery cable is disconnected at the battery terminals, the combination alarm will not work.**

Be sure to read, understand and follow the owner’s information from the manufacturer of the combination CO/propane alarm supplied in your Warranty Packet. This includes information regarding the limited life of the alarm.



LP/Carbon monoxide detector
(alarm may vary from model shown above)

⚠ WARNING

The following symptoms are related to carbon monoxide poisoning and should be discussed with all members of the household:

Mild exposure: Slight headache, nausea, vomiting, fatigue (often described as “flu-like” symptoms).

Medium exposure: Severe throbbing headaches, drowsiness, confusion, fast heart rate.

Extreme exposure: Unconsciousness, convulsions, cardio-respiratory failure, death.

SECTION 2: OCCUPANT SAFETY

Carbon monoxide (CO) is an insidious poison. It is a colorless, odorless and tasteless gas. Many cases of reported carbon monoxide poisoning indicate while victims are aware they are not feeling well, they become so disoriented they are unable to save themselves by either exiting the vehicle or calling for assistance. Young children and household pets may be the first affected.

Your combination carbon monoxide/propane alarm is designed to detect the toxic carbon monoxide fumes that result from incomplete combustion, such as those emitted from appliances, furnaces, fireplaces and auto exhaust. A carbon monoxide/propane alarm is **NOT A SUBSTITUTE** for other combustible gas, fire or smoke alarms. This carbon monoxide alarm is designed to detect carbon monoxide gas from ANY source of combustion. It is not designed to detect smoke, fire or any other gas. Please note that there are hazards against which carbon monoxide detection may not be effective, such as natural gas leaks or explosions.

This alarm is designed to sense the presence of carbon monoxide/propane gas, however there are other combustible fumes or vapors that may be detected by the sensor including (but not limited to): acetone, alcohol, butane and gasoline.

These chemicals can be found in commonly used items such as deodorants, colognes, perfumes, adhesives, lacquer, kerosene, glues, wine, liquor, most cleaning agents and the propellants of aerosol cans.

High temperatures can activate glue and adhesive vapors. If you close up the recreation vehicle on a hot day, the chemicals used in its construction may be detected for months after the vehicle was constructed (for more information, refer to Section 2, Formaldehyde).

What you should do if the alarm sounds

WARNING

Actuation of this detector indicates the presence of carbon monoxide which can kill you.

1. Operate the RESET/SILENCE button.
2. Call your emergency services (fire department or 911).
3. Immediately move to fresh air (outdoors or by an open door or window)
4. Do not re-enter the premises or move away from the open door or window until the emergency service responders have arrived, the premises have been aired out, and your alarm remains in its normal condition.

If your alarm reactivates within a 24-hour period, repeat steps 1-4 and call a qualified appliance technician to investigate for sources of carbon monoxide from fuel burning equipment and appliances, and inspect for proper operation of this equipment. Make sure that motor vehicle(s) are not, and have not been, operating in an attached garage or adjacent to the recreation vehicle.

If problems are identified during this inspection, have the alarm serviced immediately. Note any combustion equipment not inspected by the technician and consult the manufacturer's instructions or contact the manufacturer directly for more information about carbon monoxide safety and this alarm.

⚠ WARNING

Never turn the 12-volt battery disconnect control to the off position and disconnect the battery cable to silence an alarm. The alarm will automatically sense when the level of carbon monoxide in the air reaches below dangerous levels. You should stay outside the vehicle in fresh air until the alarm is silenced. When the alarm sounds, do not stand too close to the alarm. The sound produced by the alarm is loud because it is designed to wake a person in an emergency. Prolonged exposure to the alarm at a close distance may be harmful to your hearing.

Alarm Signals

- ❑ **Normal Operation:** The LED will maintain a steady green light, indicating that the alarm is powered.
- ❑ **CO alarm condition:** The red LED light will remain steady and the alarm will sound 4 “BEEPS” then silent for 5 seconds. These signals indicate immediate action is required.
- ❑ **Propane gas alarm:** The red LED light will flash and the alarm will sound a steady tone. These signals indicate immediate action is required.
- ❑ **Alarm malfunction/low battery:** The gas LED will remain off and the Operational/CO LED will alternate re/green and the alarm will sound once every 15 seconds.
- ❑ **End of life alarm:** The LED will flash red/red, green/green and the alarm will “BEEP” every 25-30 seconds. The alarm should be immediately replaced.

Maintenance

Vacuum the alarm cover at least once a year. Clean the cover by hand using a cloth dampened in clean water. Dry with a soft cloth. Do not spray the front panel of the alarm with cleaning agents or waxes. This action may damage the sensor causing an alarm or cause the alarm to malfunction. Do not paint the face of the alarm.

Testing the combination carbon monoxide/ propane alarm

⚠ WARNING

Test the alarm operation after the RV has been in storage, before each trip and at least once per week during use.

The TEST/RESET button tests all ELECTRICAL functions of the alarm. The TEST/Mute switch is located on the front of the alarm. Press and hold the test button for 1 second. The alarm is working properly if the GREEN indicator light changes color to RED and the horn beeps 4 times. The Gas LED should also blink red.



NOTE: Pressing the test button does not check the sensor operation. Refer to the carbon monoxide/propane alarm manufacturers user’s manual provided in the Warranty Packet for additional information on testing the sensors.

SECTION 2: OCCUPANT SAFETY

Repair or replace the combination carbon monoxide/propane alarm when the alarm no longer functions. As with any electronic product, it has a limited life. Alarms that do not work cannot protect you.



NOTE: The carbon monoxide/propane alarm manufacturer strongly recommends replacement of the detector five years after the date of purchase.

Refer to the Warranty Packet for more information from the carbon monoxide/ propane alarm manufacturer.

FORMALDEHYDE

Some components in the recreation vehicle contain formaldehyde-based adhesives that may release formaldehyde fumes into the air for an unknown period of time. Individuals who are allergic to formaldehyde gas fumes may experience irritation to eyes, ears, nose and throat. Indoor air quality may also be affected by leaving your vehicle closed for a period of time.

To aid in dissipation, ventilate the recreation vehicle by opening all windows and circulate the air with a fan.

This label is located inside the vehicle near the entry door. The label should be left permanently affixed to the recreation vehicle:



EXTENDED OR FULL TIME USAGE

Your new recreation vehicle has been built for enjoyment in a recreational manner. It is not intended for use as full-time quarters or a permanent residence. Continuous living in your vehicle could cause accelerated wear and damage to the various components.

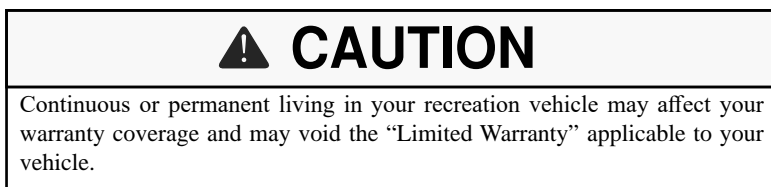

COLD WEATHER USAGE

When used in freezing or below freezing temperatures, the precautions should be taken:

- Fresh water and drainage systems - preparations to avoid freeze-ups.
- Propane gas (if so equipped) and sufficient power is needed for protection from possible freeze-ups on the propane gas regulator. Keep in mind that more frequent furnace operation will substantially increase battery draw and propane gas use.
- During cool weather usage, ventilation or addition of a dehumidifier may be required to reduce condensation.

- Check outside extrusions on compartment doors, locks, slide outs, windows, vents, etc., for frozen moisture before operating to avoid damage to parts.

CONDENSATION

WARNING

Condensation may cause dampness, mildew, mold, staining and, if allowed to continue, it may result in damage to the recreation vehicle (damage caused by condensation is not warrantable). It can also lead to mold or mildew issues, which could be a health hazard.

Condensation is a natural phenomenon. The amount of condensation will vary with climate conditions, particularly the relative humidity. Condensation occurs because there is water vapor present in the air. When the temperature reaches the “dew point” the water vapor in the air condenses and changes to a liquid form.

Proper ventilation or the use of a dehumidifier (customer supplied) will assist in controlling the condensation. Suggestions to eliminate warm moist air:

- Crack open windows and roof vents to allow warm moist air to escape.
- Open the bath roof vent (if so equipped) approximately ½” when showering.
- Use the range hood fan (if so equipped) when cooking or washing dishes.
- Avoid hanging wet towels (or clothes) inside the recreation vehicle to dry.
- If found in cabinets or closets, open the doors slightly to provide ventilation.

SECTION 2: OCCUPANT SAFETY

Notes:

TOW VEHICLE

If you plan to tow your recreation vehicle with a tow vehicle you already own, or if you plan to purchase a new one, make sure the Gross Vehicle Weight Rating (GVWR) or your recreation vehicle does not exceed your tow vehicles towing rating.

Ask your automotive dealer how to obtain a copy of information that deals with towing considerations, with or without an optional vehicle tow package.

VEHICLE LABELS

Decals and data plates used throughout the recreation vehicle aid in its safe and efficient operation; others give service instructions. Read all decals, data and instruction plates before operating your recreation vehicle. Any decal, data or instruction plate painted over, damaged or removed should be replaced.

Keep a record of the 17-digit chassis vehicle identification number (VIN), the 8-digit serial number, and your license number in the event theft or vandalism requires you to supply this information to the authorities.

WARNING

The factory-installed weight labels are specific to the recreation vehicle for which they are supplied and are not interchangeable. Do not remove these labels from your vehicle. If labels are missing contact your dealer or Customer Service for replacements.

Weight Terms

GAWR - Gross Axle Weight Rating: The value specified by the vehicle manufacturer as the load-carrying capacity of a single axle system, as measured at the tire-to-ground interfaces. This is the total weight a given axle is capable of carrying.

GCWR - Gross Combined Weight Rating: The value specified by the trailer manufacturer as the maximum allowable loaded weight of the trailer including full propane cylinders, a full load of water, and full generator fuel if applicable.

GVWR - Gross Vehicle Weight Rating: The value specified by the manufacturer as the maximum permissible weight of the fully loaded trailer.

OCCC - Occupant And Cargo Carrying Capacity: Is equal to the GVWR of the trailer, minus the weight of the trailer (as completed at the factory) minus the weight of all personal cargo, and, if applicable, minus the weight of a full tank (or tanks) of propane and the full weight of potable water, including the water heater (if so equipped). Additions to or other changes made to the trailer after it left the factory will affect (reduce) the OCCC.

UVW - Unloaded Vehicle Weight: The weight of the trailer as manufactured at the factory with the weight of a full tank (or tanks) of propane.

WARNING

- Do not exceed any applicable weight ratings. Doing so could damage your RV or tow vehicle and adversely affect handling and braking characteristics.**

SECTION 3: PRE-TRAVEL INFORMATION

Weight and Capacity Labels

The following labels are typically located on the roadside front corner of the RV. An additional Occupant & Cargo Carrying Capacity label is also located on the inward surface of the entry door.

OCCE Label (Occupant & Cargo Carrying Capacity):

The upper portion of this label is federally required and includes the maximum Occupant & Cargo Carrying Capacity that may be placed in or on the trailer as it was manufactured and weighed before leaving the factory. This maximum capacity would not include the weight of a full fresh water tank. The full load of water weight would need to be subtracted from the maximum cargo weight. Additions or other changes made to the trailer after it leaves the factory will affect (reduce) the OCCE.



OCCE Label (yellow)

The lower portion of this label is provided voluntarily and indicates the weight value of the trailer as it was manufactured and weighed at the factory. It includes full propane tanks and full generator fuel (if so equipped).



NOTE: The total weight capacity of the tires on your RV can be less than the GVWR. The calculation for the actual weight on the RV tires does not include the tongue weight. The tongue weight is actually being carried by your tow vehicle, not the RV tires.

For example: If the tires are rated at 2,000 lbs. each x 4 tires = 8,000 lbs. and the RV has a GVWR of 9,000 lbs. with a tongue weight of 1,200 lbs. The actual weight on the RV tires is (9,000 – 1,200) which equals 7,800 lbs. which is within the weight rating of the tires.

The Federal Certification Label is required by the government to verify the trailer complies with all motor vehicle standards for Canada and the United States. It includes the following information: Manufacturer name, VIN, GVWR, GAWR (front/rear), tire & rim sizes and cold tire inflation pressures.



Federal Certification Label

Tire and Loading Label provides information on the tire sizes, cold tire inflation pressures, the VIN and maximum cargo capacity. The maximum cargo capacity listed on the label does not include the weight of a full load of water.

If you have further questions, please contact your dealer or our Customer Service department.

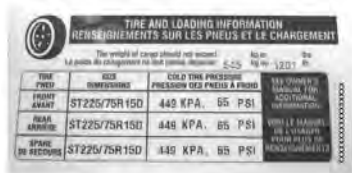

Tire & Loading Information

LOADING YOUR RECREATION VEHICLE

⚠ WARNING

Never load the RV in excess of the GAWR for either axle. Overloading your RV may result in adverse handling characteristics and damage to the chassis.

Store and secure all loose items inside the RV before traveling. Overlooked items such as canned goods, or small appliances on the countertop, cooking pans on the range or free-standing furniture items can become dangerous projectiles during a sudden stop.

Distribute cargo side-to-side so the weight on each tire does not exceed one-half of the GAWR for either axle. Store and secure all loose items inside the RV before traveling. Make sure any tie down straps (if so equipped) on appliances or furniture are secure. Load heavy objects on the floor, or as low as possible.

⚠ WARNING

Your recreation vehicle's load capacity is designated by weight, not by volume, so you cannot necessarily use all available space when loading the vehicle. Do not exceed your GVWR and ensure you are loading the vehicle as evenly as you can for the best possible handling. Ensure heavy items are secured so they do not shift during travel.

⚠ WARNING

Store items in areas designated for storage. Do not store anything in the areas reserved for the converter, electrical panels or the furnace or water heater, etc.

⚠ WARNING

DO NOT EXCEED YOUR GVWR! This means you should weigh your RV as loaded for your normal travel to determine the actual weight. If you exceed the GVWR, you **MUST** remove items from the RV, or drain liquids, then re-weigh the vehicle to ensure you have achieved a safe weight. Do not travel with full grey/black holding tanks. This not only wastes gas but, depending upon the location of the grey or black holding tanks, can affect handling characteristics.

SECTION 3: PRE-TRAVEL INFORMATION

CARGO CARRYING ACCESSORY RECEIVER (IF SO EQUIPPED)

WARNING

Receiver is for cargo carrying accessories **ONLY**. **DO NOT** tow any trailer or other vehicle. **Load Limit for this receiver is 300 lbs Maximum**. Use for towing or exceeding load limit will void the warranty. Failure to follow the instructions can cause the carrier to collapse or items to fall which could cause an accident resulting in death or serious injury.

REAR BUMPER

CAUTION

Do not add items to the recreation vehicle rear bumper. Add-on items will eventually damage your bumper. Damage caused by such aftermarket equipment installation or improper loading voids the **Towable Limited Warranty**.

The rear bumper of your recreation vehicle is not designed to carry cargo. Items that extend beyond the bumper **OR** weigh over 100 lbs. (45kg) will place undo strain on the bumper. The 100 lb. bumper capacity includes the weight of the spare tire (if so equipped).



NOTE: Some items may fall within the given weight range, (like bike racks) however, they can still cause damage. Over time, added bumper weight will cause damage from the motion created while traveling. In addition, extra weight behind the axle may reduce the hitch weigh which can adversely affect handling

TRAVEL TRAILER HITCH (CUSTOMER SUPPLIED)

Hitch selection affects the towing and handling characteristics of your recreation vehicle. There are many kinds of hitches available and assuring that you have the correct hitch installed is critical to a safe towing.

Ask your dealer about the proper class and type of hitch you need for your individual tow vehicle/RV combination. A travel trailer requires a frame mounted hitch.

The hitch class rating based on the capacity that hitch has for towing and a weight classification. The weight classification is determined from the hitch's weight carrying capacity (the tongue weight on a travel trailer). Before selecting a hitch, you must know your GVWR and tongue weight. **The rating of the hitch package purchased should be equal to or greater than the RV's GVWR and the hitch weight.**

Equipment that sometimes gives autos, trucks and sport utility vehicles a softer ride can accentuate swaying when pulling a RV. Suspension that is too stiff will increase vibration, bounce and accelerate wear of your tow vehicle and RV combination.

CAUTION

Using an oversized or undersized hitch can cause damage to the RV frame. Jayco cannot be responsible for the tow vehicle suspension system. The final ball height after the tow vehicle/travel trailer combination is completely hooked up is a factor that must be considered. To avoid overloading your trailer axles and minimize possible handling difficulties, your trailer should be level when hooked to your tow vehicle. Do not overload your tow vehicle.

Jayco cannot be responsible for the suspension system of any tow vehicle. There are a variety of tow vehicle suspension systems available that will affect the ball height, stability and levelness of a hooked up RV. Make sure your dealer is aware of the tow vehicle you are using so a compatible hookup is achieved.

Travel trailer hitch weight

Maintain the proper tongue weight of the trailer. Stay within the target range of 10%-15% of the overall gross weight (travel trailer weight plus contents).

Travel trailer hitch height & hitch ball

To determine the hitch height for your model, make sure that the trailer is level. When the loaded RV is hitched to the tow vehicle, check the hitch ball height. This can be determined by measuring the distance from the center of the hitch ball to the ground. Record this number in the box for future reference.

This unit hitch height is:

Adjust the equalizing bars of the hitch assembly so that the tow vehicle and the trailer are essentially level. A high hitch will transfer weight behind the axles and cause the vehicle to fishtail. A low hitch will transfer additional weight to the hitch. Refer to the hitch manufacturer instructions to adjust the weight-distributing hitch to the proper height.

If you have additional questions, consult with your dealer. Make certain your Dealer is aware of the tow vehicle you are using so a compatible hookup is achieved. Depending on the model, your required travel trailer hitch ball diameter is either 2" or 2-5/16" (consult your dealer for assistance).

TRAVEL TRAILER HITCHING PROCEDURE

The following procedure will help to assist you in securely hooking up your recreation vehicle to your tow vehicle.

1. Make sure the trailer wheels are blocked.
2. Turn the tongue jack crank to raise the travel trailer tongue above the hitch ball.
3. Open the coupler latch on the travel trailer hitch.
4. Back the tow vehicle into the proper position.
5. Turn the tongue jack crank to lower the coupler onto the hitch ball.
6. Close the coupler latch after it is completely seated.

SECTION 3: PRE-TRAVEL INFORMATION

7. Install the (customer supplied) weight distributing bars (equalizers) as directed by the OEM.
8. Remove the dolly wheel or platform and retract the tongue jack to its maximum height.
9. Attach the breakaway switch cable to the tow vehicle.
10. Attach the safety chains.
11. Plug in your wire harness/connector plug from the tow vehicle to the travel trailer.
12. Walk around the RV to verify exterior lights are working correctly.
13. Remove the trailer wheel blocks.



NOTE: If an Atwood brake actuator is used with an equalizing hitch, be sure the hanger chains hang between straight down and forward up to 34°. Do not use less than 6-1/2" hanger chain length. For optimum brake performance, hang chains forward 34°. Refer to the manufacturer's owner's manual for more information.

Travel Trailer Weight Distributing System (Customer Supplied): This system provides a more stable tow vehicle/RV combination as it will spread the weight evenly to distribute it to the tow vehicle front and rear axles and the trailer axle. Consult with your dealer for information on requirements and operation of this system. Be certain your tow vehicle can carry the hitch weight.

Travel Trailer Sway Control (Customer Supplied): Sway control devices are available to reduce the sway produced by crosswinds, air displacement caused by other vehicles passing you in transit, incorrect weight distribution, excessive speed, the RV tires dropping onto the shoulder of the road, etc. The use of sway control will help to control the side-to-side movement and keep sway in check. Consult your dealer for additional information.

Suggestions for sway situations:

- Slowly ease your foot off the accelerator.
- Turn the steering wheel as little as possible. Natural lag time reaction when counter-steering to correct sway could possibly make it worse.
- If the trailer is equipped with electric brakes, using the hand control will help to keep the vehicles aligned.
- As soon as possible, stop to determine the cause of the sway. Check all equipment and load distribution. If the problem cannot be solved immediately, contact your dealer for a service appointment. Travel at a much reduced speed until the issue is resolved.

WARNING

A sway control device (customer supplied) should be used with your tow vehicle/travel trailer combination. Consult with your Dealer to obtain the proper equipment for your needs.

Travel Trailer Safety Chains: Your RV is equipped with chains to meet SAE standard requirements for maximum gross trailer weight.

SECTION 3: PRE-TRAVEL INFORMATION

Always have the safety chains attached when towing. Install them as shown below so they do not restrict sharp turns, but tight enough so they do not drag on the ground.

Crisscross the left safety chain under the coupler and attach to the right mounting slot in the trailer hitch; repeat with the right safety chain. Slack for each length should be the same but not more than necessary to permit the vehicle to turn at its minimum radius, but tight enough not to drag on the ground.

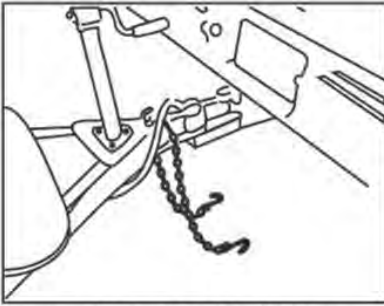

1. Inspect chains to determine if they are properly attached to trailer frame.

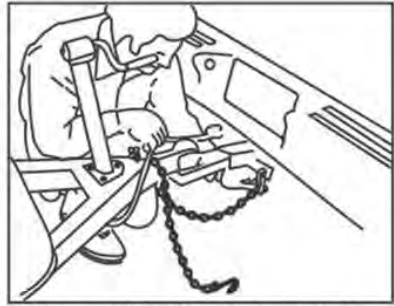

2. Criss-cross left chain and attach to right mounting slot in tow vehicle hitch.

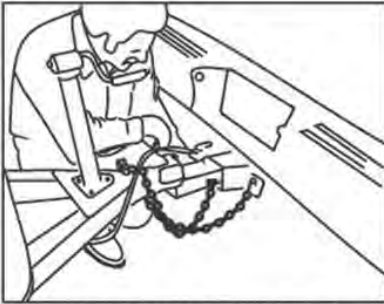

3. Repeat Step 2 with right chain. Slack for each length should be the same but not more than necessary to permit the vehicle to turn at the minimum radius.

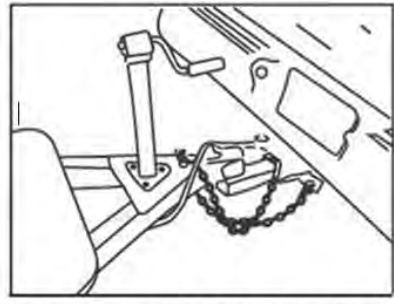

4. Properly mounted safety chains. Note that the jack is fully raised and dolly wheel removed.

Safety chain installation

SECTION 3: PRE-TRAVEL INFORMATION

WIRE HARNESS/CONNECTOR PLUG

A 7-way wire harness/connector plug is wired into your trailer to connect electrical power from the tow vehicle for travel. This supplies power to the RV brakes, tail lights, clearance lights, turn signals, brake lights, etc. Wiring to operate your brakes must be the same size in both the tow vehicle and RV (the RV brake wiring is 12-gauge wire).

When attaching wires to your tow vehicle, tape all the connections for moisture protection.

White	1	Ground
Blue	2	Brakes
Green	3	Running lights
Black	4	Auxiliary battery charge line
Red	5	Stop & left turn
Brown	6	Stop & right turn
Yellow	7	Back up



7-way trailer plug -
car end-rear view

The connector plug may build up corrosion with extended use and should be cleaned periodically to insure good electrical contact. Make sure the connector plug is kept clean and protected from road elements as you travel.

WEIGHING YOUR TOW VEHICLE & RV

When the RV is fully loaded it should be weighed. The actual weight of the vehicle, all options, liquids, the hitch weight, and your personal cargo is important for you to know so you do not exceed the GVWR. Two important factors when loading your RV are total weight and balance.

It is imperative that you verify compliance within all applicable weight ratings. Overloading your RV will void the **Towable Limited Warranty** and the warranties of many component part manufacturers.

Periodically weigh your RV at a public scale to determine proper load distribution. To obtain the side-to-side weights, there needs to be enough space on either side of the scale to accommodate the RV being partially off the scale.

Keep in mind that individual scales will operate differently.

To weigh your tow vehicle and RV

⚠ WARNING

Total weight of your tow vehicle and RV must not exceed the GCWR. Do not assume that you can tow a RV that happens to be within the capacity of the tow vehicle hitch. By doing so, you may exceed the total GCWR of your tow vehicle and RV towing combination.

Your RV must be weighed fully loaded (with food, clothing, fuel, water, propane, supplies, etc).

1. Weigh the RV including the tongue weight, while detached from the tow vehicle. This actual overall weight must be less than or equal to the GVWR for safe operation. If the overall weight is greater than the GVWR, some contents must be removed until the

actual overall weight is less than or equal to GVWR.

2. Hitch the RV to your tow vehicle. Weigh the RV and the tow vehicle to determine the GCW. Make sure that this rating is less than or equal to the GCWR as specified by the manufacturer of your tow vehicle. If this overall weight is greater than the GCWR, some contents must be removed to bring the combination into compliance with the listed ratings.
3. Weigh the RV while attached to but excluding the tow vehicle. This will result in the actual weight that is exerted on all of the RV tires. This weight may be subtracted from the overall RV GVWR to determine the actual “tongue” weight.
4. With the RV still attached to the tow vehicle, weigh each wheel position separately to ensure each tire is not overloaded.

To determine the wheel position weight:

5. Pull the RV onto the scale so only one tire is on the scale. Record the weight. Your RV must remain as level as possible on the scale (even though an axle or side is not physically on the scale).
6. To calculate the opposite side of the RV wheel position weight, subtract the first side’s weight from the weight determined in step #3.

If there is a difference in the weights on one side of the vehicle as compared to weights on the other side, components (tires, wheels, brakes, springs, etc.) on the heavier side could be overloaded, even though the total axle load is within the GAWR.

Once actual weights are obtained, compare them to the **Weight Information Label** weight ratings to ensure you are below the posted minimum ratings.

WARNING

It is important to redistribute the load to avoid component failure as well as to improve the handling characteristics of the vehicle and not void the **Towable Limited Warranty**.

See the *Weight Terms* and *Loading Your RV* sections for important weight information.

SECTION 3: PRE-TRAVEL INFORMATION

Notes:

TOWING

⚠ WARNING

Your RV braking system is rated for operation at GVWR not GCWR.

⚠ WARNING

Whenever possible, do not travel with waste in the holding tanks. Liquid or debris in the holding tank(s) may affect the towing characteristics and may result in property damage or personal injury.

⚠ WARNING

The propane cylinder(s) should be turned off when traveling. Most refrigerators will keep food cold or frozen for eight hours without running while you travel.

Your RV will travel safely and comfortably at highway speed limits. It will take longer than a passenger automobile to reach that speed. Allow more time to go around vehicles you are passing. Avoid situations that might require sudden momentum changes as the length of the tow vehicle/RV combination affects your ability to quickly cut back into traffic. Swerves and sharp turns, especially at high speeds, could result in loss of control of the tow vehicle/RV.

Even though your RV is equipped with brakes designed for GVWR, proceed with caution until you become accustomed to your RV's stopping distance. Slow down in advance of dips, bumps and railroad tracks to reduce the jolting to your tow vehicle/RV combination. Proceed slowly and let the trailer tires pass over them before accelerating.

Adverse weather conditions and extremes in terrain may affect the performance and handling of your tow vehicle. Do not operate the tow vehicle cruise control on icy or extremely wet roads, winding roads, in heavy traffic or in any other traffic situation where a constant speed cannot be maintained.

When descending a long hill, drop down into a lower gear or range. Avoid conditions that require excessive and prolonged use of your brakes. Apply and release brakes at short intervals to allow them to cool. The tow vehicle transmission and engine will help in controlling downhill speed and can lengthen brake life. Use care when accelerating or decelerating on a slippery surface. Abrupt speed changes can cause skidding and loss of control.

Driving through water deep enough to wet the brakes may affect stopping distance or cause the vehicle to pull to one side. Check the RV's brake operation in a safe area to be sure they have not been affected. **Never operate any vehicle if a difference in braking efficiency is noticeable.**

Know the weight and size of your towing combination and observe any posted weight and clearance limits. The added height of roof air conditioners, TV antennas or floodlights may cause clearance problems around some tunnels, canopies and hanging signs.

SECTION 4: VEHICLE OPERATIONS

When turning, the tires do not follow the path of your tow vehicle tires. The RV will make a tighter turn than the tow vehicle. Compensate for this action by carefully pulling the tow vehicle out into the intersection further than you would normally so that the RV clears the curb. When making a turn, check the road clearance and be aware of others. Swerves and sharp turns, especially at high speeds, could result in loss of control of the RV.

If your camping destination does not have pull through sites, pick a level site and back in carefully. Check to ensure there are no obstacles in your path and that you have plenty of vehicle clearance.

After the RV is in the desired location, set the tow vehicle parking brake. Block all RV wheels securely with wheel chocks to prevent it from rolling.

TOWING BEHIND YOUR RV

WARNING

If you do not have a **Jayco factory installed hitch receiver**, towing items behind your Jayco RV, or overloading the rear, will void the warranty and may result in: damage to the RV or add-on items, towing difficulties, property damage and/or personal injury.



NOTE: IF YOU DO NOT HAVE A JAYCO FACTORY INSTALLED HITCH RECEIVER, DO NOT TOW ANYTHING BEHIND YOUR RV. THE RV FRAME AND BUMPER ARE NOT DESIGNED FOR TOWING.

RV BRAKE SYSTEM

WARNING

Failure to maintain the brakes in proper working condition as specified in the operator's manual supplied by the axle OEM will cause property damage, personal injury and possibly death. Consult with your dealer for assistance.

Electric brakes

The electric brakes are designed to work with the tow vehicle brakes. To maintain proper braking performance, both the RV and tow vehicle brakes must be used together. Separate use of the braking systems will cause accelerated wear and damage.

When your RV is new, it is impossible to adjust the brake shoes precisely. It takes approximately 1,000 miles and/or 50 medium to heavy stops to "burnish" fit or "seat" the shoes to the brake drum. After the initial break-in period your brake shoes must be adjusted accurately for best performance and increased durability.

Braking system components include:

- Tow vehicle battery
- Brake controller
- Wire harness/connector plug
- Trailer battery
- Breakaway switch

The tow vehicle battery is the primary source of power for your RV's electric brake operation. To ensure available power when needed, keep your tow vehicle battery and charging system working properly.

Brake controller (customer supplied)

The brake controller should be installed in the tow vehicle to work in conjunction with the RV electric brakes. Consult with your dealer or the brake controller OEM to decide what is right for your towing combination.

Hydraulic brakes (if so equipped)

Your RV may be equipped with hydraulic surge brakes that operate automatically as the tow vehicle's brakes are applied. When speed is decreased and brakes are applied, the weight of the trailer moving forward creates a reaction which causes the brake fluid inside the wheel cylinder to activate the brake shoes against the drum.

As a result of this design, backing the RV uphill may activate the surge brake system making it difficult to continue in reverse. To aid in backing up the RV;

1. Prior to backing up a slope or through soft ground, pull the recreation vehicle forward slightly to assure that the actuator socket is in the forward position.
2. Move the lever on the side of the actuator downward from the "towing position" along the curved slot in the actuator frame to the "backup position." The slot has a notch at the bottom of its travel. Push the lever down to engage the locking notch.
3. The RV will now back up. This lever will slide into the correct position when pulling forward.

It is extremely important to keep the master cylinder full at all times. An empty cylinder invites moisture.

TRAVEL TRAILER BREAKAWAY SWITCH

CAUTION

NEVER use the breakaway switch and trailer brake system as a parking brake. Doing so would create a high amp draw on the battery and converter. This can cause damage to wiring, connectors and the breakaway switch.

The breakaway switch is a crucial part of the RV braking system. Located on the travel trailer A-frame, this switch will apply the trailer brakes if the trailer becomes detached from the tow vehicle. Attach the breakaway switch lanyard to a permanent part of the tow vehicle (on a travel trailer do not attach it to the hitch ball or similar removable parts) when hitching the trailer. If the RV becomes detached from the tow vehicle, the pull pin will be pulled from the switch. This automatically causes the switch to "close" and activates the RV brakes.

A battery (customer supplied) must be installed to activate the breakaway switch.

SECTION 4: VEHICLE OPERATIONS

ENTRANCE DOOR STEP(S)

Make sure your entrance step is fully extended before exiting the vehicle, and retracted prior to towing.

Lubricating the step mechanism

Carefully clean the area around the pivot points (the rivets involved in the motion of the mechanism). Lubricate these pivot points with an automotive grade, non-staining lubricant every 30 to 60 days.

Wipe any excess lubricant off of the step and then clean the entire step after lubricating.

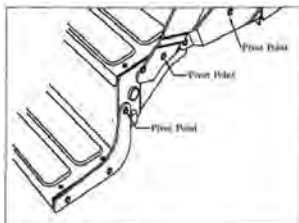

RV Step

ENTRANCE DOOR



CAUTION

Make sure the entrance door is completely closed and locked when traveling. Locking the door helps prevent it from opening unintentionally.

Always hold onto the entrance door when opening or closing it as damage caused because you failed to do so is not covered by the **Towable Limited Warranty**.

KEYS

Several keys are provided when you purchase your vehicle. Most keys have an individual key number stamped on the plate. Record these key numbers and keep the information in a safe place. You can order a key blank from your dealer to have duplicate keys made. If you lose the keys, contact your dealer or a locksmith for assistance. Make sure the keys are not inside the vehicle before you close and lock the **entrance door**.



NOTE: Locks on entrance and baggage doors need biannual lubrication using a light coat of silicone spray. Conditions such as rain, salt, dust and pollution may increase the maintenance needs.

REAR BACKUP CAMERA PREP

Your recreation vehicle has been pre-wired to allow installation of a (customer supplied & customer installed) rear backup camera. Wiring is in place to install the camera at the rear of the vehicle, and has been routed to the master bedroom to allow a hookup for the camera monitor. This feature allows you to use also use your camera as a security monitor.

Depending on your model, you may also have a pre-installed power switch for the camera located in an exterior compartment.

To install a backup camera, refer to the manufacturers installation guide along with the installation supplement provided in the warranty packet.

CAMPSITE HOOK-UP

- Refer to *Electrical System* section before connecting the shore line power cord (when using full hook-up) OR before starting the generator (if so equipped) or operating the vehicle on 12-volt power when dry camping.
- Refer to *Fuel & LP System section before using the LP system*. Open the LP gas tank valve (if so equipped) slowly. There may be air in the lines and five to thirty seconds of time is needed to bleed air before LP vapor fills the lines.
- Refer to *Plumbing Systems* section before connecting the fresh water supply or turning ON the water pump or water heater.
- When using full hook-up, connect the sewer hose to the campsite sewer hook-up.
- If applicable, start the refrigerator and the cooling or heating system.



NOTE: For extended dry camping, management of all your resources is essential. Check your battery levels and conserve battery power, use it sparingly.

LEVELING THE RV

Now that you have parked your recreation vehicle, you need to ensure it is level. Leveling is very important. A level vehicle is more comfortable for sleeping and walking.

The refrigerator is designed to operate when level for best performance due to the absorption system. The water drainage systems are designed with proper slope and must be level for proper operation. The appliances perform best when level.

STABILIZER JACKS

1. Each stabilizer jack can be individually adjusted to stabilize the trailer for use.
2. When setting your RV up on soft ground, you may wish to place a wood pad or the equivalent under each stabilizer jack foot. This will help keep the stabilizer jack from sinking into the ground.

Manual stabilizer jacks (if so equipped)

1. To lower each jack, insert the jack crank onto the applicable stabilizer jack shaft.
2. Turn the crank clockwise to lower each leg until it contacts the ground and stabilizes the trailer.

To raise each jack, insert the jack crank onto the applicable stabilizer jack shaft and turn the crank counter-clockwise.

Electric stabilizer jacks (if so equipped)

Control switches for the stabilizer jacks are located on the (door) side of the unit above the stabilizer jack(s).

To lower each jack, press the control switch until each leg contacts the ground and stabilizes the unit.

To raise the jack, press the control switch until the jack is returned to the retracted position.

SECTION 4: VEHICLE OPERATIONS



NOTE: The stabilizer jacks must be fully retracted before moving or towing the RV to prevent stabilizer jack damage.

WARNING

DO NOT USE THE STABILIZER JACKS TO LEVEL THE RV. It is important to remember that the stabilizer jacks are to be used only for support while occupying and moving around the RV. They are not designed to support the weight of the RV.

EMERGENCY STOPPING

Always carry road flares or reflective warning signs to display if necessary. Pull off the roadway as far as possible for emergency stopping or tire changing. Turn ON your vehicle hazard warning flashers. If traveling at night, use three red warning indicators such as flares, reflectors or lanterns as required by the Uniform Vehicle Code and Model Traffic Ordinance as follows:

1. Place the first warning indicator on the traffic side of the recreation vehicle, directed at the nearest approaching traffic.
2. Place the second warning indicator 100 feet behind the recreation vehicle in the center of the lane and toward approaching traffic.
3. Place the third warning indicator 100 feet in front of the recreation vehicle in the center of the lane and away from the traffic approaching from behind.



NOTE: Curves and/or hills may affect the safe placement of warning indicators.

WARNING

For personal safety, always stand off the road and out of the way of traffic.

EMERGENCY TOWING

WARNING

Never allow anyone to go under the recreation vehicle while it is being lifted and/or being towed.

If your recreational vehicle needs to be towed, please contact an emergency road service provider or a qualified service facility for assistance.

WHEEL LUGS

After your first trip, check the wheel lug torque periodically for safety. Check the wheel lugs after winter storage, after a wheel removal, before starting a trip or following extensive braking. Use the correct star pattern sequence to attach the recreation vehicle wheels (see **Wheel Lug Torque Chart**.)

1. Start all nuts by hand to prevent cross threading.
2. Tighten the nuts in the sequence shown.
3. Tighten the lug nuts equally in stages as indicated for your recreational vehicle wheels (see **Wheel Lug Torque Chart**).

Check and re-torque after the first 10, 25 and 50 miles (16, 40 and 80 kilometers). Thereafter, check and maintain the torque according to the listed torque values (see **Wheel Lug Torque Chart.)**



NOTE: The proper method of tightening wheel lug nuts is with a properly calibrated torque wrench and socket, not with an impact wrench or by hand. Do not use a 4-way lug wrench or any other type of wrench that does not measure the actual pressure applied to the lug nut.

Because of the importance of having proper torque on the wheel lug nuts, you should always have the wheels mounted and properly torqued by a qualified technician using the proper tools.

SECTION 4: VEHICLE OPERATIONS

WHEEL LUG NUT DIAGRAMS:

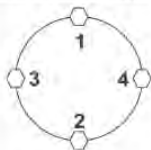

4-Lug Nuts

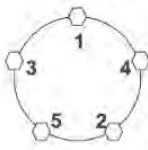

5-Lug Nuts

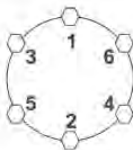

6-Lug Nuts

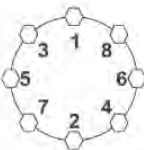

8-Lug Nuts

WHEEL TORQUE INSTRUCTIONS:

1. Start lug nuts with fingers on studs to avoid cross threading
2. Stage 1, Torque: Impact lug nuts in a star pattern until snug to rim. -- See *Wheel Lug Nut Diagram*
3. Stage 2, Torque: Use calibrated torque wrench to torque each lug nut, in a star pattern, to the values indicated. Wheels must remain stationary during torquing process for control purposes. --See *Wheel Lug Nut Torque Chart* and *Wheel Lug Nut Diagram*
4. Stage 3, Torque: Use calibrated torque wrench to torque each lug nut, in a star pattern, to the values indicated. Wheels must remain stationary during torquing process for control purposes. --See *Wheel Lug Nut Torque Chart* and *Wheel Lug Nut Diagram*

WHEEL LUG NUT TORQUE CHART:

Lug Nut	Stud Dia.	Rim	Type	Stage 1 Impact Gun	Stage 2 Clicker Setting (+/-3ft/lbs)	Stage 3 Clicker Setting (+/-3ft/lbs)	Acceptable Torque Range
4-Lug Nuts	1/2"	12"	Steel	40-50 ft/lbs	60 ft/lbs	70 ft/lbs	50-75 ft/lbs
5-Lug Nuts	1/2"	13"	Chrm/Steel	40-50 ft/lbs	60 ft/lbs	70 ft/lbs	50-75 ft/lbs
5-Lug Nuts	1/2"	14"	Chrm/Steel/Alum	40-50 ft/lbs	95 ft/lbs	115 ft/lbs	90-120 ft/lbs
5-Lug Nuts	1/2"	15"	Chrm/Steel/Alum	40-50 ft/lbs	95 ft/lbs	115 ft/lbs	90-120 ft/lbs
6-Lug Nuts	1/2"	15"	Chrm/Steel/Alum	40-50 ft/lbs	95 ft/lbs	115 ft/lbs	90-120 ft/lbs
6-Lug Nuts	1/2"	16"	Chrm/Steel	40-50 ft/lbs	95 ft/lbs	115 ft/lbs	90-120 ft/lbs
8-Lug Nuts	1/2"	16"	Steel/Aluminum	40-50 ft/lbs	95 ft/lbs	115 ft/lbs	90-120 ft/lbs
8-Lug Nuts	5/8"	17.5"	Aluminum	50-60 ft/lbs	125 ft/lbs	150 ft/lbs	140-160 ft/lbs

TRANSPORTATION INSTRUCTIONS:

1. Prior to travel and after excessive braking, all wheel lug nuts must be checked for torque.
*This also applies to any service involving wheel or lug removal, during the life of the recreational vehicle.
2. Torque readings must fall within the Acceptable Torque Range: --See *Wheel Lug Nut Torque Chart*
3. Torque specifications, must be checked by using a torque wrench.
*Digital or Dial Torque Wrenches are recommended.
4. If Torque falls below the Acceptable Torque Range, additional torque is required.
-- See *Wheel Torque Instructions* and *Wheel Lug Nut Diagram* for the correct pattern and recommended final torque value.
5. During travel, wheel lug nuts must be checked and re-torqued, as required, after the first 10 miles, 25 miles, 50 miles, then periodically during travel (16 kilometers, 40 kilometers, 80 kilometers, then periodically during travel).
-- See *Wheel Torque Instructions* and *Wheel Lug Nut Diagram* for the correct pattern and recommended final torque value.
6. Failure to follow these instructions may result in wheel loss, an accident, or loss of control, resulting in death or serious injury.

⚠ WARNING

Check and tighten wheel lug nuts regularly to make sure they did not loosen during travel. Wheel lug nuts must be applied and maintained at the proper torque levels to prevent loose wheels, broken studs and possible separation of the wheel(s) from your recreation vehicle. The lug nuts on the wheels of your recreation vehicle must be maintained according to listed torque values (see **Wheel Lug Torque Chart**.) Over-torqued and/or under-torqued wheels may result in component failure.

Failure to maintain proper torque of the wheel lug nuts could lead to separation of the tire and wheel while driving, possibly resulting in property damage or personal injury.

TIRES

Read and understand the following before taking your first trip in your recreation vehicle!

Proper care and maintenance of your tires is essential to ensure your safety, as well as the safety of others, as you travel.

Routine maintenance on your recreation vehicle is important, but it cannot be overstated just how critical proper tire maintenance is to the safety, operation and durability of your new vehicle.

You must follow the manufacturer's inflation guidelines for maximum load capacity; under-inflation is just as dangerous as over-inflation.

To insure your tires are operating safely, regular inspection of your tires and checking tire pressures is absolutely mandatory.

Examine your tires frequently for unusual wear. Alignment, balance and bearing wear will affect tire wear. Make sure to look for cracking, bulging, uneven tread wear, etc.

When you are using your vehicle, check inflation pressure weekly to insure maximum tire life and travel wear. Pressure should be checked when the tires are cold. During travel, tires heat up and pressure increases. **Do not bleed air from hot tires or your tires may then be under-inflated.**



NOTE: Cold tire inflation pressure is defined as a tire that has not been used for three or more hours, or has been driven less than one mile. Tire inflation pressure of a hot tire may show an increase of as much as 6 psi over a cold tire.

Tire pressure is the most important factor in the life and performance of your tires. Proper inflation should be monitored closely. Failure to do so could result in the overheating of a tire, which could result in a blowout. Inflation pressure should be as recommended by the tire manufacturer or as the federal label for the recreation vehicle indicates.

⚠ WARNING

It is recommended that the tire pressure be checked at the beginning of each trip to obtain the maximum life of the tire. Follow the instructions listed on the Federal Certification label, affixed to the roadside front corner of your trailer, to determine the correct tire pressure. Under-inflation may cause tire failures and swaying; this may result in loss of control, injury, death or property damage.

⚠ DANGER

Failure to follow proper inflation guidelines may result in tire failure, which, under certain circumstances can cause loss of vehicle control or accidents that may result in property damage, bodily injury or death.







⚠ WARNING

This recreational vehicle is equipped with special trailer (ST) tires that have a maximum speed rating of 65 MPH (104 km/h). **You should not exceed this speed rating.** Exceeding the tire speed rating may result in tire failure, which could lead to a crash causing serious injury or death.

⚠ CAUTION

Tire wear should be checked frequently. Once a wear pattern becomes firmly established in a tire it is difficult to stop, even if the underlying cause is corrected.

Tire Wear Diagnostic Chart

Wear Pattern		Cause	Action
	Center Wear	Over Inflation	Adjust pressure to particular load per tire catalog.
	Edge Wear	Under Inflation	Adjust pressure to particular load per tire catalog.
	Side Wear	Loss of camber or overloading	Make sure load doesn't exceed axle rating. Align at alignment shop.
	Toe Wear	Incorrect toe-in	Align at alignment shop.
	Cupping	Out-of-balance	Check bearing adjustment and balance tires.
	Flat Spots	Wheel lockup & tire skidding	Avoid sudden stops when possible and adjust brakes.

CHANGING A TIRE

WARNING

Do not use the stabilizer jacks to support the recreational vehicle while under the vehicle or changing tires. The stabilizer jacks are designed as a stabilizing system only. Do not use the stabilizer jacks as a jack or in conjunction with a jack. Attempts to change tires while supporting the recreational vehicle with the stabilizer jacks could result in damage to the vehicle and risk causing serious injury or death.

WARNING

Never raise the recreational vehicle by placing the jack under the axle, springs or any attachment parts. Failure to comply could result in property damage, personal injury, or death.

1. Keep the recreational vehicle attached to the tow vehicle. Block the tire on the opposite side of the recreational vehicle from the tire you are changing.
2. Loosen the wheel lug on the tire you are changing before jacking up the vehicle. **DO NOT** remove the lug nuts; only loosen them for ease of removal when the tire is off the ground.
3. Locate the main frame rail of the trailer (it spans from front-to-back just inside the tires).
4. To raise the recreation vehicle, place the jack (hydraulic or screw) under the main frame rail. It must be just ahead of the front tire or just behind the rear tire.

WARNING

Be sure to use only tires that are rated for recreation vehicle use. The use of passenger tires should be avoided. The load rating/range embossed on the sidewall of passenger tires must be de-rated accordingly; they do not have the same load capability as tires that are specifically identified for recreation vehicle use. Failure to use tires that are properly matched to your recreation vehicle could lead to premature tire wear or less than optimum trailer handling.

Replacement

If you experience a flat tire on your recreation vehicle while driving, gradually decrease your vehicle speed (if possible). Hold the steering wheel firmly and move the recreation vehicle to a safe place on the side of the road.

Any service or warranty coverage on tires is to be handled by the tire store representing the brand installed on your RV. They are not to be returned to your dealer or Jayco.

SECTION 4: VEHICLE OPERATIONS

⚠ WARNING

When replacing a tire make sure to replace it with a tire of the same size and specifications (refer to the Federal Certification label.)

If you have questions regarding your tires, contact the tire manufacturer or Jayco Customer Service.

SPARE TIRE CARRIER (If So Equipped)

If your recreation vehicle is equipped with a spare tire, it will either be mounted under the unit (hoist) or on the rear bumper.

Hoist mount

⚠ WARNING

DO NOT exceed the maximum load capacities of 100 lbs. for the hoist. DO NOT use air driven guns or impact wrenches to lift the spare tire to the travel position.

Depending on your model, the spare tire may have (side or bottom) brackets or it will be mounted against the underside of the recreation vehicle (flush mount) to give it stability in travel.

NOTE: If your spare tire is a flush mount application, it must make contact with the underside of the recreation vehicle to insure maximum road clearance and stability in travel.



Hoist mount with brackets
travel position



Hoist mount/flush mount
travel position

Raising and lowering the hoist

In most cases the crank handle to raise and lower the tire will be located in a basement compartment of the recreation vehicle. Typically, it is fastened to the sidewall of the compartment. Insert the crank handle into the crank access port located either in the center of the rear bumper, or in the sidewall of the RV. Turn the crank handle to lower the tire, or to lift into the travel position. Two "crisp breaks" must be heard and felt to insure the proper seating of the tire for travel.



Crank access port



NOTE: If the manual crank access port is located in a slideout, the slideout room must be in the travel position. If the slideout is extended the crank will not reach the mechanism to raise or lower the tire.

Securing the spare tire

To secure the spare tire in the travel position, put the steel hoist lift support located on the end of the cable through the rim of the tire. The hoist lift support clips need to seat inside the center hole of the tire rim. The valve stem of the tire **MUST** be pointed in the up position or toward the bottom of the RV. Reverse this process to release the spare tire for usage.



Bumper mount

The spare tire bracket can be released and extended down to access a storage compartment at the rear of the trailer without removing the tire.

To extend the tire down

1. Remove the cotter key from the pin holding the tire carrier in place.
2. Remove the pin and extend the tire carrier away from the trailer.
3. Always return the tire carrier to the upright position and lock it in place while traveling.



To remove the tire from the tire carrier

1. Remove the lug nuts holding the tire in place.
2. Remove the support bracket from the bottom lug.

Pull the tire from the tire carrier.



Bumper mount

To install the tire on the tire carrier

1. Place the tire on the carrier with the top lug bolt inserted into one of the holes in the tire rim and the bottom lug bolt in the center of the rim.
2. Install the top lug nut.

SECTION 4: VEHICLE OPERATIONS

3. Place the support bracket over the bottom lug bolt across the center of the rim.
4. Install the bottom lug nut over the support bracket.
5. Make sure the lug nuts are tightened securely before returning to travel.

TRAVEL TRAILER SET UP

1. Position the RV as desired.
2. Level the RV (side-to-side).
3. Block the wheels securely to prevent the RV from moving.
4. Unhook the wire harness/connector plug, safety chains and breakaway switch lanyard.
5. Install the dolly wheel or platform.
6. Release the weight distributing bars (customer supplied).
7. Open the tongue jack coupler latch.
8. Turn the tongue jack crank to raise the coupler above the hitch ball.
9. Level the RV (front-to-back) with the tongue jack crank.
10. If applicable, lower the stabilizer jacks.
11. Pull the tow vehicle away, as desired.

PATIO AWNING

WARNING

Awnings must be closed (and locked if applicable) while the RV is in transit.

CAUTION

The effects of wind and rain on an awning are unpredictable and can cause severe damage to the awning and/or the recreation vehicle. **Retract the awning if:**

- If wind or extended periods of rain are expected
- If you leave the RV unattended for a length of time to avoid unexpected climate conditions.

Awning care

Keep your awnings clean and in good condition to prevent costly repairs.

- Periodically check that the fasteners are tight. Tighten if necessary.
- Keep the awning fabric clean. For detailed cleaning information, refer to the manufacturer's owner information included in the Warranty Packet.

The 12-volt power awning (if so equipped) may need to be adjusted (retracted) to operate the entry door (some models).

For detailed safety and operating information, refer to the manufacturer's user guide included in the Warranty Packet.

OPERATING POWER AWNINGS (If So Equipped)

⚠ WARNING

Awnings must be closed (and locked if applicable) while the RV is in transit.

⚠ CAUTION

It is recommended that if leaving the recreation vehicle unattended for a length of time, retract the awning to avoid unexpected climate conditions.

⚠ CAUTION

The effects of wind and rain on an awning are unpredictable and can cause severe damage to the awning and/or the recreation vehicle. If wind or extended periods of rain are expected, retract the awning.

Your recreation vehicle may be equipped with multiple (power) awnings which will each have its own control switch. The control switch(s) for each awning is typically located on the command center switch panel located inside the entrance door. Pressing and holding the switch will extend or retract the awning.

Carefree® LONGITUDE Awnings (If So Equipped)

These awnings offer various features that make them easy and convenient to use. These features include:

- Scissor style arms that do not require vertical ground supports.
- Adjustable arms that provide easy to use 6 position pitch adjustment
- Roller tube and arms that are made from light weight no-rust aluminum
- 100% billow-proof worm gear driver motor eliminating the need for travel locks.
- Single switch operation, 12V motorized awning.

Refer to the manufacturer's user guide for detailed operating and safety information.

Adjusting the Awning Pitch

The longitude arms have 6 pitch adjustment settings from minimum pitch to maximum pitch. The awning can be extended and retracted in any of these positions without having to reset the pitch between uses.

⚠ WARNING

Do not set the individual arm pitch at more than three (3) positions different between the left and right arms. Damage to the arms and the canopy can occur if the awning is retracted when the arms are set at more than three (3) positions difference.

⚠ CAUTION

Use care when adjusting the pitch as the awning may move abruptly.

SECTION 4: VEHICLE OPERATIONS

1. Hold on to the awning arm to keep it steady while adjusting the pitch.
2. Press in the pitch adjustment pins located on the scissor arm.



NOTE: Applying LIGHT pressure on the arm will decrease the force required to press the pitch adjustment pins.

3. Slide the scissor arm to the desired set hole – towards the coach for a lower pitch and away from the coach for a higher pitch.

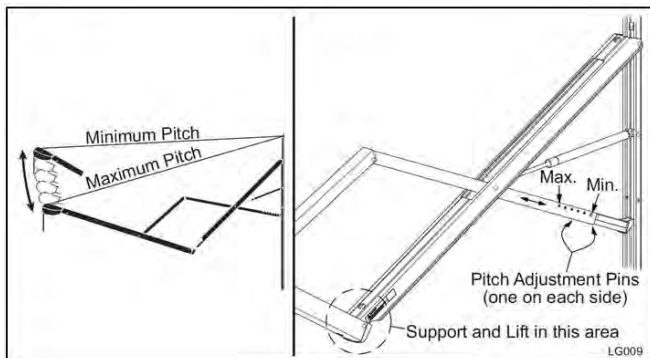

Emergency Operation

If power to the vehicle is not available, the awning can be safely retracted by jumping the motor using a 10VDC – 14VDC power source such as a cordless drill battery or car battery.

⚠ WARNING

DO NOT USE A 110VAC POWER SOURCE FOR THE EMERGENCY OVERRIDE PROCEDURE! Doing so will permanently damage the awning! Do not use the Emergency Override without following the directions below.

⚠ WARNING

For awnings under 12 feet: The arms must be set at an equal pitch. Damage to the arms and canopy can occur if the awning is retracted with the arms uneven.

1. Remove the front cover. The cover snaps onto the rear cover. To remove, press on both sides of the rear cover until the front cover releases then lift the cover off.
2. Detach the RED and BLACK wires from the cable to the motor.
3. Attach jumper wires to the motor wires.

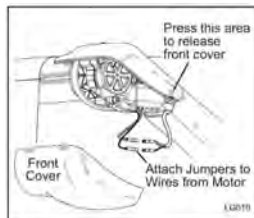

SECTION 4: VEHICLE OPERATIONS

4. Connect the other ends of the jumper leads to the 10VDC – 14VDC source. If the awning moves in the wrong direction, reverse the leads. Maintain contact throughout the retraction process.
5. When the awning is closed, remove the jumper wires and reattach the cable wires to the motor wires. Be sure to match RED to RED and BLACK to BLACK.
6. Snap the front cover onto the rear cover. Hang the cover on the top and swing it down until it clicks.

Additional Awning Operation Information

- The awning motor is equipped with a thermal protection circuit to protect the motor from overheating. Operating the awning repeatedly over a short time period may cause the circuit to sense an overheat condition and shut off the motor. If this occurs, wait approximately 15 minutes to allow the motor to cool then operate the awning in normal fashion.
- The awning seems to extend and retract slowly. Normal operation time is 28-35 seconds to extend or retract. If the power supply is on the low side of the acceptable voltage range (10VDC – 14VDC) the awning will move slower.

If the awning does not operate, contact the Carefree Service Center. Visit the Carefree website at www.carefreeofcolorado.com for a listing of service centers.

- Always operate the awning according to the instructions.
- Periodically check that the fasteners are tight. (Tighten if necessary)
- Keep the awning fabric and arms clean.

SECTION 4: VEHICLE OPERATIONS

Notes:

ELECTRIC SLIDE ROOM(S) (IF SO EQUIPPED)

The slideout room system is designed for additional floor space and comfort. The mechanical components are gear driven. Electric powered slideout room systems have a manual override to allow you to extend or retract the slideout room(s) in case of a power loss. Make sure you have sufficient power available before operating your slideout system.

⚠ WARNING

Make sure the interior slideout room path and the slideout room itself is clear of people and objects before operating. Keep away from the slide rails and gear assembly when the room is in motion. They may pinch or catch on loose clothing causing personal injury. **Failure to follow these instructions could result in serious injury or death.**

⚠ CAUTION

These guidelines should be followed when using your slideout room:

- The recreation vehicle **must be level** before operating the slideout room. Water leaks and other problems could result if the slideout is operated without leveling the RV.
- Do not place excessive weight** in the slideout room. It can cause the slideout room to malfunction and cause damage to the slideout.
- Do not over extend/retract the slide out room. Release the switch immediately once the room has been fully extended/retracted. Over extending/retracting the slide out room may result in damage to the stop rod and bracket.
- Additional support jacks are not needed under the slideout. Damage can occur to your slideout room from improper use of aftermarket support jacks.

⚠ CAUTION

Make sure the slideout is in the closed position prior to hooking the unit to the tow vehicle.

Operating the slideout system:

- The auxiliary battery (customer supplied) must be fully charged** and connected. **If possible, the RV should be hooked up to 120-volt AC power** so the converter operates.
- The RV must be level and the stabilizer jacks in the extended position.
- Slideout switches are typically located inside the RV, either in the command center or on the wall.
- To extend the slideout**, locate the slideout control switch and press the OUT section of the switch; hold until the slideout room stops (travel time is approx. 25 seconds).
- To retract the slideout**, press the IN section of the slideout control switch and hold it until the slideout is fully retracted.

SECTION 5: SLIDEOUT SYSTEMS

Operating the switch after the room is fully extended or retracted may damage the switch and motor.

After the slideout is extended, verify that the corners of the black rubber seal are set up correctly. The corners of this seal are cut at a 45° angle. The top of the outside seal must overlap the side of the seal to avoid the possibility of water penetration. On the inside seal, the side seal should overlap the top.



Slideout overlap-*outside*

Maintenance

⚠ WARNING

Do not work on your system unless the 12-volt DC (auxiliary battery, customer supplied) and 120-volt AC electrical systems (shore line power cord) have been disconnected.

Your slideout system will require very little maintenance. To ensure a long life of your slideout system, read, understand and follow these instructions. This system contains a pre-lubed bearing that is lubricated when the room is moved in and out. Do not spray oil or grease on the rails while the room is extended.

Troubleshooting the Slideout

If the slideout does not move when the slideout switch is depressed, follow these steps.

- Check the auxiliary battery (customer supplied) for a full charge and good wire connections.
- Check the 12-volt fuse or circuit breaker.
- Check for loose connections at the slideout motor.

If the slideout still will not operate, follow these steps.

- If the slideout is extended, refer to the section on operating the specific slideout system installed on your RV.
- If the slideout is retracted, leave it in that position.
- Contact your dealer or customer service for repair assistance.

SLIDEOUT SYSTEMS

Your RV may be equipped with one or more of the following slideout systems.

Schwintek Inwall slideout system

The in-wall slideout system requires no maintenance it will never require any adjustments. This system has two vertical columns. Each side has a drive motor located at the top of the column. The right and left hand motors remain synchronized by a circuit board.

⚠ CAUTION

Additional support jacks are not needed under the slideout. Damage can occur to your slideout room from improper use of aftermarket support jacks.

1. The auxiliary battery (customer supplied) must be fully charged and connected. When possible, the recreation vehicle should be hooked up to 120-volt AC power so the converter operates.

SECTION 5: SLIDEOUT SYSTEMS

2. The recreation vehicle must be level and the stabilizer jacks in the extended position.
3. Slideout switches are typically located on the inside of the recreation vehicle, either in the command center panel or on the wall. To move the room out, press the OUT section of the switch and hold it until the motor stops (travel time is approx. 25 seconds)

Some models may be equipped with a wireless remote control to operate the slideout. To operate the slideout using the remote:

- Press the on/off button to power on the remote.
- Select the slideout you want to operate by pressing the corresponding button.
- Press and hold the (extend/retract) arrow button to move the room in or out.
- Press the on/off button once more to power off the remote.

DO NOT try and time the end of the stroke by releasing the button early.

ALWAYS allow the controller to stop both motors before releasing the switch button.



NOTE: Do not operate the switch after the room is fully extended as damage can occur to the motor and/or switch.

Retracting slideout room

Press the IN section of the slideout control switch and hold it until the motor stops.



NOTE: Operating the switch after the room is fully retracted will damage the switch and motor.

Maintenance

⚠ WARNING

Do not work on your system unless the 12-volt DC (auxiliary battery, customer supplied) and 120-volt AC electrical systems (shore line power cord) have been disconnected.

Your slideout system has been designed to require very little maintenance. To ensure a long life of your slideout system, read, understand and follow these simple instructions. This system contains a pre-lubed bearing that is lubricated when the room is moved in and out. Do not spray oil or grease on the rails while the room is extended.

Trouble shooting the Inwall slideout system

Checking Fuses: The inwall slide requires a minimum 30 Amp fuse. Check the load center for blown fuses and replace any if necessary.

If the fuse blows immediately upon replacement, there is a problem with the wiring to the inwall slide control box. A qualified service person should be called to check and repair.

Obstructions: Check outside for possible obstructions such as a tree, post or car etc. Check

SECTION 5: SLIDEOUT SYSTEMS

inside the vehicle for any obstructions such as luggage, furniture or open cabinets etc. Also check for smaller objects that may be wedged under the floor or in the sides of the unit. Remove any obstructions before proceeding.

Error Codes: Refer to the error codes section for codes and instructions on how to locate the inwall slide controller.

Low Voltage: The inwall slide controller is capable of operating the room with as little as 8 volts. But at these lower voltages the amperage requirement is greater. Check the voltage at the controller. If voltage is lower than 11 volts, it is recommended that the battery be placed on a charger until it is fully charged. It may be possible to “jump” the RV battery temporarily to extend or retract the room. Consult Customer Service before attempting to “jump” the auxiliary battery.

Only 1 Side Moving: The slide room has a separate motor to operate each side of the room. If only 1 side of the room is moving, then with another person’s assistance press the switch to extend or retract the room while pushing the non-moving side in the appropriate direction. On larger rooms it may be necessary to have 2 or more people pushing the room.

Non-moving side moved manually: Try to push the non-moving side in and out. If a motor shaft has broken then it will be possible to move that side of the room several inches by hand. Larger rooms may require several people to push.

Debris in the rack: Check all 4 gear racks on the side of the room for debris.

Do the status LEDs light? Locate the slide controller for the slideout in question. When the room slideout direction switch is actuated, do the status LEDs light up. Check this in both the extend and retract modes.

Manual override for the inwall slideout

The slideout system comes with an “electronic” manual override. In event the slide out does not extend or retract follow these steps to override the system which should allow the slideout to be retracted.



NOTE: Fuses for the slideouts can be found in the load center and may be designated as auxiliary or slideout motor.

1. Locate the slideout system controllers. There should be one for each slideout on the recreation vehicle. They are typically located in a forward section basement compartment, either on the forward wall or on the ceiling. In some models they may be behind a cargo lined panel.
2. The controller that has malfunctioned should have a flashing red LED indicating a halt signal fault (will flash 8 or 9 times).
3. Press the “mode button” six times quickly, then press a seventh time and hold for approximately 5 seconds.
4. The red and green LED’s will begin to flash indicating you are in override mode. Release the mode button.
5. Use either a wall switch, or one of the slide room switches located on the command

center panel (depending on the slideout). Press the switch toward the word IN or RETRACT (printed next to the switch) and hold it until the unit comes in completely.

- This will allow you to get the recreation vehicle to a service center to have the slideout malfunction diagnosed.

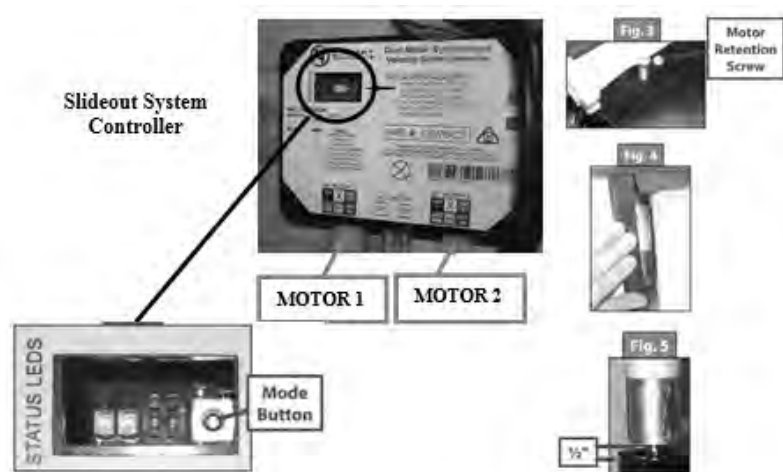

⚠ CAUTION

During this override procedure the motors are not synchronized. Visually watch the room, and if one side is moving significantly slower than the other (or not at all), immediately stop and call your dealer or Customer Service.

⚠ CAUTION

If the system stalls out before reaching end of stroke OR if the room does not close and seal tightly, call your dealer Customer Service.

Manually pushing in the slideout

- Locate the slideout system controller
- Unplug motor 1 and motor 2 connectors at the bottom of the slideout controller. This releases the motor brakes for each motor.
- The slideout room can now be manually pushed in. Larger rooms may require several people to push or pull them.
- Keep both sides of the slideout relatively even while pushing/pulling.
- When the room is completely in, plug both motor connectors back into the control module.** This will apply the motor brakes for road travel.

Disengage motors, manually retract the room and travel lock

SECTION 5: SLIDEOUT SYSTEMS

6. Locate and remove the motor retention screw which can be found near the top of each vertical column (Fig. 3).
7. Bend back the wipe seal and visually locate the motor (Fig. 4).
8. Pull the motor up until it disengages (about 1/2 inch).
9. Repeat this process for both sides of the slide room.
10. Physically push or pull the room back into the opening, keep both sides relatively even.
11. The room must be travel locked to keep the room in place for road travel.

WARNING

DO NOT MOVE THE RV UNLESS THE MOTORS ARE PLUGGED IN TO THE CONTROLLER AND THERE IS BATTERY POWER TO THE RV. THIS SETS THE BRAKES ON THE SLIDEOUTS TO PREVENT THEM FROM MOVING DURING TRANSIT.

Error Codes

When an error code occurs during operation, the board will use the LEDs lights to indicate where the problem is. For motor specific faults the green LED will blink (1) time for motor #1 and (2) times for motor #2. The red LED will blink from 2 to 9 times depending on the error code. Error codes are as follows:

2 times **Battery drop out:** battery capacity low enough to drop below 6 volts while running.

3 times **Low battery:** voltage is below 8 volts at the start of a cycle.

4 times **High battery:** voltage is greater than 18 volts.

5 times **Excessive motor current:** high amperage, also indicated by (1) side of the slide continually stalling.

6 times **Motor short circuit:** motor or wiring to motor has shorted out.

8 times **Hall signal not present:** encoder is not providing a signal; usually a wiring problem.

9 times **Hall power short to ground:** power to encoder has been shorted to ground; usually a wiring problem.

When an error code is present, the board needs to be reset. Energizing the extend / retract switch will reset the board. Energize the extend / retract switch again to go back to normal operation.

Refer to the Schwintek Slide Room Operation Guide for further information. Contact Lippert or visit the Lippert website at www.lci1.com for additional troubleshooting information.

Flush Floor Slideout

For optimum performance, the slide-out system requires full battery current and voltage. Although the system is designed to be almost maintenance free, actuate the room once or twice a month to keep the seals and internal moving parts lubricated. Check for any visible signs of external damage after and before movement of the travel trailer.



NOTE: For long-term storage it is recommend the room be closed (retracted).

Trouble shooting the flush floor slideout

If the slideout does not move when the slideout switch is depressed, follow these steps:

- Check the auxiliary battery (customer supplied) for a full charge and good wire connections.
- Check the 12-volt fuse or circuit breaker.
- Check for loose connections at the slideout motor.

If the slideout still will not operate, follow these steps:

- If the slideout is extended, refer to the following section on overriding the specific slideout system installed on your RV.
- If the slideout is retracted, leave it in that position.
- Contact your dealer or customer service for repair assistance.

If the slideout extends crooked or only one side moves, follow these steps.

- Follow steps on overriding the specific slideout system installed on your RV.
- You may need to push the side that is not sliding to get it to retract all the way.
- Contact your dealer or customer service for repair assistance.

Manual Operation for the flush floor slideout



CAUTION

Always disconnect battery from system prior to manually operating system. Failure to disconnect battery can cause electricity to backfeed through the motor and cause serious damage to the system as well as void the warranty

The electric slide comes with a manual over ride system. Locate the crank extension under the inside of the frame (refer to Fig. 1 and 2).

This is where the crank handle (standard fifth wheel landing gear crank handle or 3/4" socket and ratchet fits on to allow the manual extension/retraction of the room (Fig. 3 and 4). Simply take the wrench, ratchet or drill with a nut driver and rotate it clockwise to retract and counterclockwise to extend slide-out.

It is important to note that Just hook up and crank. Use **EXTREME CAUTION** when extending and/or retracting room using the manual override feature. It is possible to operate the slideout beyond the maximum extension and/or retraction and damage the slide components, slide room structure or trim components.

SECTION 5: SLIDEOUT SYSTEMS

MANUAL OPERATION - THROUGH FRAME



Fig. 1-Through Frame Crank Extension w/pin



Fig. 2- Crank Handle

MANUAL OPERATION - IN FRAME



Fig. 3-Hex Head Crank Extension



Fig. 4-Ratchet



CAUTION

The gears can be stripped out if the room is manually retracted/extended to its fullest extent and the operator continues to rotate manual override. Any damage due to misuse of the Manual Override feature will disqualify any and all claims to the Limited Warranty.

Power Gear® Slideout

The Power Gear® electric slideout is a rack and pinion design operated by a 12 Volt DC electric motor. It consists of 4 major components:

- Inner rail assemblies to support the room weight.
- A 12 Volt DC gear motor to operate the room using power from the onboard battery.
- A manual override that allows you to extend or retract the room in the event of a loss of power.
- A control that gives the user full control of room movement, in or out. The control has a sensing capability that stops the motor when the room is fully extended or retracted.



NOTE: For long-term storage: It is recommended the room be closed (retracted).

Electric Operation

 WARNING

- Always make sure the slideout room path is clear of people and objects before and during operation of the slideout room.
- Always keep away from the slide rails when the room is being operated. The gear assembly may pinch or catch on loose clothing causing personal injury.
- Install transit bars (if so equipped) on the slideout room during storage and transportation.

FAILURE TO FOLLOW THESE INSTRUCTIONS COULD RESULT IN SERIOUS INJURY OR DEATH.

Extending the room

1. Level the unit.
2. Main Power switch at stepwell (locations may vary) must be ON.
3. Verify the battery is fully charged and hooked up to the electrical system.
4. Remove the transit bars (if so equipped).
5. Press and hold the IN/OUT switch in the OUT position until the room is fully extended and stops moving.
6. Release the switch, which will lock the room into position. If the slideout switch is held after the room is fully extended, the control will sense that the room has stopped and will shut the motor off after a few seconds.

Retracting the room

1. Verify the battery is fully charged and hooked up to the electrical system.
2. Press and hold the IN/OUT switch in the IN position until the room is fully retracted and stops moving.
3. Release the switch, which will lock the room into position. If the slideout switch is held after the room is fully extended, the control will sense that the room has stopped and will shut the motor off after a few seconds. Install the transit bars (if so equipped).

Manual Operation for the Power Gear slideout system

Your slideout system is equipped with a manual override that allows you to extend or retract the room in the event of a loss of power.

 WARNING

When the motor brake is disengaged the slideout room **WILL NOT** lock into place; therefore, the room will not be sealed. When the room has been manually retracted, be sure to install the transit bars (if so equipped) and return the motor brake lever to its normal engaged position in order to seal and lock the room into position.

CAUTION

Always disconnect battery from system prior to manually operating system. Failure to disconnect battery can cause electricity to backfeed through the motor and cause serious damage to the system as well as void the warranty

CAUTION

Use **EXTREME CAUTION** when extending/retracting the room using the manual override feature. The gears can be stripped out if the room is manually retracted/extended to its fullest extent and the operator continues to rotate manual override. Damage can also occur to the slide components, slide room structure or trim components. Damages due to misuse of the manual override feature will void any and all claims to the Limited Warranty.



NOTE: If the room does not move when the switch is pressed, check the following:

- Make sure the slideout system is turned on.
- Battery is fully charged and connected.
- Transit bars have been removed (if so equipped).

When these items have been checked and **the room still does not move when the switch is pressed, follow the steps below to manually override the slideout room.**

1. Turn the Main Power OFF. The override will not work if it has power going to it. **Do not work on the system unless the battery is disconnected.**
2. Locate the slideout controller. There are two versions of the controller.
Version 1, unplug the 6 pin wiring harness from the controller.
Version 2, remove one of the motor leads, either the motor I or motor II lead from the controller.
3. Locate the slideout motor (Fig. 1). It will be mounted to one of the slideout rails. If the RV has an underbelly or cover over the motor, these parts will need to be removed to access the motor. In a bedroom slideout, it may be located under the bed.
4. Rotate the brake lever, on the backside of the motor, counter-clockwise (looking from the rear of the motor) about 1/8 of a turn to the released position (Fig. 2). This will release the brake that holds the room in place.
5. Locate the manual override for the slideout system (Fig. 1).
6. The room is now free to move. Using either a 5/8" or 3/4" wrench or socket, crank the room either in or out completely. If the slideout system is supplied with a gearbox override (optional), use the crank handle to move the room.
7. When the room is fully in (or out) have one person apply pressure to the wrench/ratchet and return the brake lever to its engaged position. This ensures the room is locked into a sealed position.

SECTION 5: SLIDEOUT SYSTEMS

8. Install the transit bars (if so equipped) to the slideout room and take the unit to an authorized dealer for service.

Fig. 1 - Motor & manual override general location

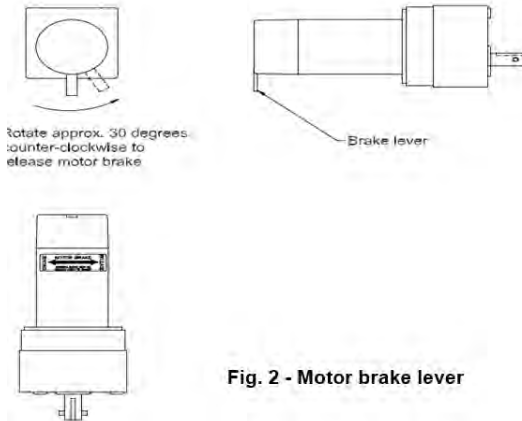
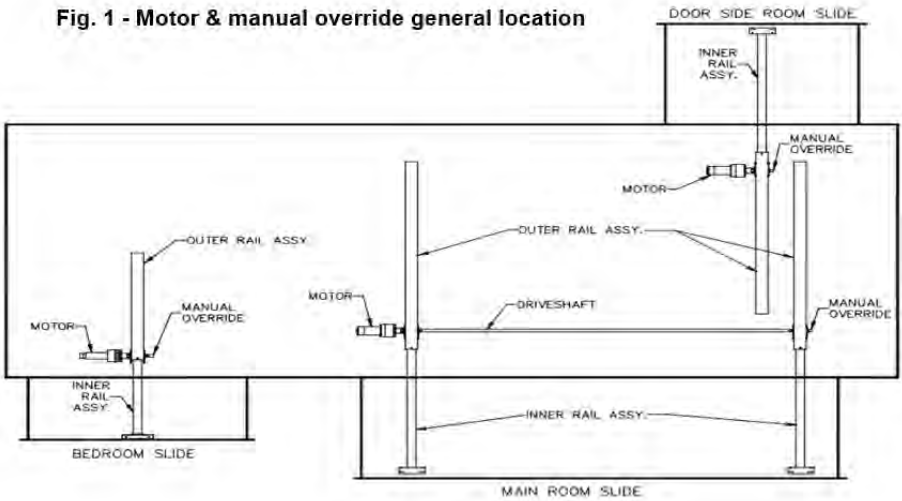

Fig. 2 - Motor brake lever

Refer to the Power Gear® Electric Slideout Operation Manual for detailed operation, safety and troubleshooting information.

Norco Slideout

The Norco slideout system is a cable driven slide out.

- When the power switch is activated the cables guide the room in or out.
- Accu-Slide mechanism powers all 4 corners evenly keeping the room perfectly square.
- Motors and cables are hidden out of sight behind the interior fascia board around the slideout opening.
- Cables may stretch over time. Average stretch will be approximately 1/8" but it will not affect the function and does not require adjustment.

SECTION 5: SLIDEOUT SYSTEMS

- Slideout runs off of the DC power in the RV.
- Rubber wipes prevent debris from entering the unit and precision actuation guides the bulb seals to close tightly.
- Self locking motor freezes the room in any position of travel.
- Slideout is supported by rollers or wear bars not the cables. Cables are used to keep the slideout balanced on the rollers.

If the room will not move:

Generally if the room will not activate, there is no 12V power to the drive motor. The motor is equipped with a hex drive override shaft. This drive can be activated using an electric drill and the flexible shaft provided with each unit (or use a ratchet to actuate the motor) to pull the room in or out. If the motor is functioning, check the room for obstructions.

Manually Moving The Room – Norco slideout

1. Locate the included flexible shaft in your owner's packet.



2. Attach flexible shaft to the 1/4" hex fitting on the end of the motor.



3. Attach 1/4" socket & ratchet, or drill to the other end, and turn in the proper direction to move the room.



4. If the cables tighten, and the motor is difficult to turn, **REVERSE THE DIRECTION. OVER-TORQUEING CAN HAPPEN, RESULTING IN SEVERE DAMAGE.**

Power Gear® Slim Rack Slideout System

The Power Gear® Slim Rack slideout is typically used for slideouts 144” long and longer.

- It is operated by a 12VDC electric motor.
- The system is equipped with a manual override allowing the room to be extended / retracted in the event of a power loss.
- The system has a controller (Fig 1) with programmable stops that stop the motor when the room is fully extended or retracted.
- The controller has the ability to detect faults for easier troubleshooting.
- A wall mounted touchpad allows room movement and provides end user feedback.



Fig.1 Slideout Controller

Operating the Slideout

The slideout will not function until the stops are properly set or faults are cleared.

A solid “ON” GREEN LED indicates room movement.

The RED LED indicates a fault or a problem with the system. (Refer to the *Fault Diagnostics / Troubleshooting* section for additional information).



Figure 4 Touchpad

Prior to moving the slideout room set the parking brake.

To ensure ample voltage is being supplied to the slideout system motor, power should be supplied from one of the following sources:

- Attach the RV to shore power
- Have the motorhome engine running
- Turn on the generator

Extending the room:

1. Engine or generator must be running, or plugged into shore power.
2. Transmission must be in park (or neutral if applicable).
3. Set the parking brake and level the unit.
4. Remove transit bars (if equipped).
5. Turn **ON** the on/off switch or key.
6. Press and hold the OUT button (See Fig 4 above). There will be a slight delay before the room begins moving, this is normal.
7. The GREEN LED should be solid ON when room is in motion.
8. Release the OUT button when the room is fully extended and stops moving.
9. Turn **OFF** the on/off switch or key.

Retracting the room:

1. The engine or generator must be running, or plugged into shore power.
2. Transmission must be in park (or neutral if applicable).

SECTION 5: SLIDEOUT SYSTEMS

3. Set the parking brake and level the unit.
4. Turn **ON** the on/off switch or key.
5. Press and hold the IN button (See Fig 4 above). There will be a slight delay before the room begins moving, this is normal.
6. The GREEN LED should be solid ON when room is in motion.
7. Release the IN button when the room is fully retracted and stops moving.
8. Turn **OFF** the on/off switch or key.
9. Install transit bars (if equipped).

Fault Diagnostics / Troubleshooting:

This control has the ability to detect and display several faults. When a fault is detected the room movement stops and two different LEDs will flash in a pattern.

The RED FAULT CODE LED (Fig 4) will flash RED a number of times corresponding to a specific fault code. Refer to the Fault Codes Chart to determine the fault.

The GREEN ROOM MOVEMENT LED (Fig 4) will flash GREEN a number of times corresponding to which motor has the associated fault.

For example, if you see four (4) RED flashes and two (2) GREEN flashes it would indicate there is a motor fault on Motor 2.

There are two types of faults; MAJOR and MINOR. Faults must be cleared in order for the room to operate normally.

- **MINOR** faults can be cleared by pushing and releasing the **IN** or **OUT** buttons on the wall touchpad (Fig 4).
- **MAJOR** faults must be cleared by pushing and releasing the **SET STOPS/CLEAR FAULTS** button located on the back of the wall touchpad. (Fig 2)



Figure 2 Set Stops/Clear Fault Button



Figure 3 Room Slideout Motor Buttons

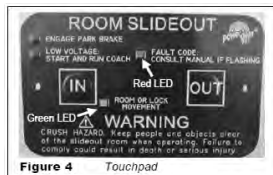

Figure 4 Touchpad

NOTE: For MAJOR faults, the control must be overridden by following the EMERGENCY RETRACT MODE in the OVERRIDE MODES section.

SECTION 5: SLIDEOUT SYSTEMS

Fault Code	Fault Type	Fault Codes		
		Description	Possible Cause	Possible Solution
1	Major	Stops not programmed	-Stops have not been set -Stops were cleared -Stops were improperly set	Steps need to be programmed by an authorized service facility.
2	Minor	System Fault	-Obstruction present -Excessive system drag	Run room in opposite direction. If it continues to move in the opposite direction, remove obstruction, excessive weight in room or repair of damaged component. If room stops moving in opposite direction, observe fault code and refer to this chart
4	Major	Excessive Battery Voltage	-Bad or loose connection -Defective harness -Open or shorted motor	-Check all connections at control box and motor -Check the harness for broken wires. -Put 12.0 VDC direct to the motor. If it does not run replace the motor.
6	Minor		Supply voltage to control box is 17.0 V DC or greater	Check 2-pin power connector at control box. If the voltage is 17.0 VDC or higher, contact O.E.M for power and ground supplies
Park brake LED flashing			-Parking brake not set (if applicable) -Ground signal lost at park brake control	-Set parking brake (if applicable) -Check for continuity to ground on wire plugged into park brake connector at control box
Low voltage LED flashing			Incoming voltage to control box is below 12.0 VDC	Check 2-pin power connector at control box. If voltage is below 12.0 VDC contact O.E.M for power and ground supplies.

Preventative Maintenance:

Your Power Gear® slideout system is designed to require very little maintenance. To ensure long life of your slideout system read and follow these few simple procedures:

- When the room is extended, visually inspect the slide rail assemblies. Check for excess buildup of dirt or foreign material; remove any debris that may be present.
- If the system squeaks or makes any noises, blow out any debris from the gear rack arms and apply a dry lubricant to prevent and/or stop squeaking.

Refer to the Power Gear® website (www.powergearus.com) CONTACT tab if you have any problems or questions.

OVERRIDE MODES:

In the event of component failure or loss of system power, your slideout can be manually overridden and retracted for travel.

SECTION 5: SLIDEOUT SYSTEMS

NOTE: At any time during the override procedure, the unit will exit this mode if the room has not been moved for two (2) minutes or if a fault is detected during room movement. The Fault Code (RED) and Room or Lock Movement (GREEN) LEDs will flash rapidly for 10 seconds to indicate the override procedure failed. After 10 seconds of flashing, the control will automatically default to FAULT CODE 1. Programming must be restarted.

NOTE: The room control will need to be re-programmed by an OEM authorized dealer after the system has been overridden.

Emergency Retract Mode:

Use this procedure when there is **NO** loss of power or electrical problem with the system.

1. Remove the touchpad (Fig 4) from the wall.
2. Prior to clearing the MAJOR fault, record the number of RED & GREEN flashes observed on the touchpad (Fig 6). This information will help your dealer/service center in troubleshooting the slideout system.
3. Press and hold the SET STOPS/CLEAR FAULTS button on the back of the touchpad for five (5) seconds (Fig 2). Both RED & GREEN LEDs will be on solid while pressing this button. After 5 seconds, the GREEN LED will begin flashing and the RED LED will remain solid on.
4. The unit is now ready to retract the room. Press and hold the ROOM SLIDEOUT MOTOR buttons 1 and 2 on the back of the touchpad (Fig 3).

# of RED flashes	# of GREEN flashes

Figure 6



CAUTION

It is very important to note that during this procedure, the slideout control has **NO** stop locations. Use a second person to assist in determining when the room is retracted. Damage to the room can occur if the room is retracted too far.

Press the IN button on the front of the wall touchpad until the room is fully retracted. If one side of the room needs to retract further in order to get a good seal, press and hold the motor button (Fig 3) corresponding to **ONLY** the motor you want to move. Press the IN button on the front of the touchpad to retract the room the remainder of the way.

5. Re-install the wall touchpad.
6. Take the unit to an OEM certified dealer for repairs.

Manually Retract Room with Ratchet & Socket:

In the event that power is lost to the slideout motor(s) or the override mode above will not work, the room may be manually retracted using a ratchet and socket attached to the end of the coupler (Fig 11).

1. You need to gain access to the VERTICAL CHANNEL assembly from either inside or outside of the coach (whichever is more convenient). Remove the OEM trim and flange pieces on the slideout room box.
2. If applicable, remove the top screw from the bulb seal at the top of the VERTICAL CHANNEL (Fig 8).
3. Pull down the bulb seal and remove the motor cover (Fig 9). The motor seal may stick to the bulb seal.
4. Using a pick tool, remove the end of the retaining spring from the motor spring clip (Fig 10A). If not equipped with a retaining spring, loosen the motor retaining screw (Fig 10B).
5. Unplug the motor from the harness and remove the motor by lifting it up and out.
6. Repeat steps 1-4 for the other side.
7. Place a socket wrench with a 3 inch extension and a 5/8" deep well socket (Fig 12) through the motor access opening and seat the socket onto the coupler (Fig 13). One man alternating from side to side of the room can retract a 1500 lb. room with or without a ramp.



NOTE: 1 person on each side of the room with a ratchet and socket will expedite the process. Room moves ¼ inch for every 30 to 40 degree turn of the wrench.

8. Secure the room in place by either:
 - Re-installing the motors (making sure the end of the retaining screw is re-hooked to the motor spring clip (Fig 10A).
 - Torque the motor retaining screw to 40 inch/lbs. (Fig 10B) and the motor retainer is fully engaged.
 - Use a travel lock, (a 2x4 cut to size), etc.
 - Refer to Fig 10A and 10B for proper seating of the motor.
9. Have the slideout room serviced by an OEM authorized dealer as soon as possible. Do not operate the room until service is complete as damage to the room may result.

SECTION 5: SLIDEOUT SYSTEMS

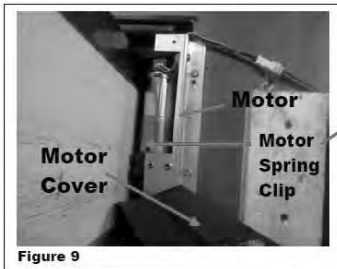

NOTE: Motor shown properly seated. No gap between mounting bracket and block.



For further information refer to the **Slim Rack In Wall Slide Out System Owner's Manual**, or visit Lippert's website @ <http://www.lci1.com/assets/content/support/manuals/pg-3010002679.pdf>

THE ELECTRICAL SYSTEM

The RV electrical system is comprised of two independent electrical systems. One operates off of 12-volt DC power and the other off of 120-volt 60hz AC power. All installations have been made in compliance with industry standards applicable on the date of manufacture. Because the electrical equipment and associated circuitry are engineered into a dedicated system specific to your RV, do not make unauthorized changes or add fixed appliances to it. **Changes or additions made after delivery may result in a hazardous condition.**

Service and/or modification of the electrical system should only be performed by qualified electrical technicians using approved materials, components, and methods meeting current safety and code requirements. Please consult your dealer's service department for assistance.

To read more about the various components incorporated into the RV electrical system, please refer to the information contained in your Warranty Packet.

Electrical System Maintenance

Before working on the electrical system; always disconnect the shore power cord, turn off the battery disconnect switch (if so equipped) and turn off the 120V main circuit breaker. Then disconnect the negative 12VDC battery terminal from the battery. Refer to *Battery Disconnect Switch & Load Center* sections.

WARNING

Use caution when using metal tools. If a tool contacts a battery terminal or metal connected to it, a short circuit could occur which could cause personal injury, explosion or fire.

COMMAND CENTER

The command center is typically located just inside the entrance door or in the living area of the recreation vehicle. It contains switches and controls for electrical functions for the RV. Depending on your model, the command center may be a panel complete with switches, or it can be a group of switch pods mounted to a recessed panel inside a cabinet. Some models may have the switches and controls mounted directly to the wall in the living area or vicinity of the entrance door. In some cases, the systems monitor (which indicates tank levels and battery charge) may also be included on this panel (refer to the *Monitor Panel* section).



NOTE: Command center configurations and components may vary from model to model. Not all components listed may be available in your model.

SECTION 6: ELECTRICAL SYSTEMS

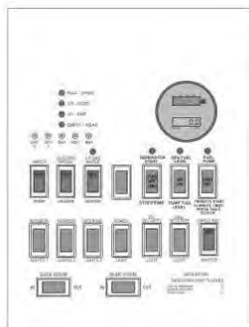

Command Center Panel



Command Center Panel
W/Switch Modules



Mounted to wall

Command Center Panel:

Items found on this panel typically include (may vary by model):

- Fuel gauge and hour meter with switches for fuel pump and fuel levels
- Lighted red pump switch, lighted red water heater switches (electric & LP gas)
- Generator start / stop switch
- Tank heater switches
- Light switches for porch lights, exterior security lights, interior lights, awning LED lights, front cap LED accent lights
- Cargo bed red lighted master control switch
- Slideout control switches (press and hold to extend / retract)
- Awning control switches (press and hold to extend / retract)

Command Center Panel with Switch Modules:

Items may include separate switch modules and controls that are mounted to a recessed plastic panel. Items found on this panel typically include (may vary by model):

- Systems monitor with LED indicators for tank levels and battery charge status
- Systems monitor includes lighted red switches for pump and water heater
- Slideout switches (press and hold to retract / extend slideouts)
- Light switches for porch lights, exterior security lights, interior lights, awning LED lights, power entry step
- Awning switches (press and hold to retract / extend awning)
- Auto leveling control panel (for leveling the recreation vehicle)
- Inverter panel (power switch with display)
- Generator start / stop control with hour meter
- Cargo bed red lighted master control switch

- Power bunk bed lift control switch
- Fuel gauge with fuel station on/off switch
- Speaker selector switch

Command Center Modules Mounted to the Wall

Some models may have the modules mounted directly to the interior wall of the vehicle. They are typically located near the entrance door. They may include any of the modules listed above.

GFCI RECEPTACLE

There is a ground fault current interrupter (GFCI) engineered into the electrical system. It is designed to reduce the possible injury caused by electric shock. The GFCI will not protect against short circuits or circuit overloads.

Test all GFCI receptacles monthly

- Push in the GFCI “TEST” button. The GFCI “RESET” button should pop out indicating the GFCI receptacle has been “tripped” and interrupted 120-volt power.
- Push in the GFCI “RESET” button to restore 120-volt power.

Contact your independent dealer for assistance if the GFCI “RESET” button does not restore 120-volt power and pops back out.

A “tripped” GFCI breaker indicates that abnormally high 120-volt current flow (a ground fault) was detected. A fault condition can be caused by faulty wire insulation, wet wiring inside an appliance, faulty electrical equipment connected to the circuit, etc. All ground faults must be repaired before use of the recreation vehicle.

TESTING THE CAMPSITE POWER CONNECTION

The campsite 120-volt power receptacle(s) should always be tested for proper functionality prior to plugging the recreation vehicle shore power cord into it.

Campsite 120-volt power receptacles can be tested using a digital multimeter or a dedicated circuit analyzer. Dedicated circuit analyzers plug directly into the campsite power receptacle and minimally test for open neutral, open ground, and correct polarity. Polarity indicators can be purchased in most electrical and hardware stores.

WARNING

Do not hook up the power cord to any receptacle until you have verified proper polarity and grounding.

DO NOT plug the shore power cord into a campsite receptacle(s):

- That has reverse polarity
- With non-functioning ground circuits
- That shows outward signs of heat damage.

Doing so may result in property damage or serious injury. Damage or injury resulting from connection to malfunctioning or improperly wired power sources is **not** covered by your recreation vehicle warranty.

WARNING

- Do not use any cheater plug, adapter or extension cord to reconfigure incoming AC power or break the continuity of the circuit connected to the grounding pin.
- Do not connect the power cord into an outlet that is not grounded, or adapt the power cord plug to connect it to a receptacle for which it is not designed.
- Do not remove the grounding pin to connect to a non-grounded receptacle. Removal of the ground pin disables an important safety feature designed to prevent shock and electrocution hazards.
- Do not connect the power cord to an extension cord. Use of an improper extension cord will cause overheating of the cord as well as potentially causing premature failure of the AC equipment.

It is the responsibility of the owner of the electrical receptacle to ensure that the receptacle is properly wired and grounded. Reverse polarity and/or improper grounding of your RV can cause personal injury or death.

CONNECTING THE POWER CORD

WARNING

Plugging the shoreline power cord into an incorrectly wired power source could damage the recreation vehicle electrical system and result in severe or fatal injury.

Always test the external power source (i.e., the campsite power receptacle or electrical box) with a ground monitor before connecting your power cord to it. If the ground monitor indicates 'reverse polarity' or an 'open ground' **DO NOT** connect the power cord.

To help prevent power surges from damaging the connected loads, please follow these instructions when hooking up to the external power source:

1. Turn "off" the load center main 120-volt circuit breaker.
2. Carefully extend the entire length of the power cord (approximately 25'-35') from the electric cable hatch to the external power source.
3. Plug the power cord into the receptacle. Be sure all the power cord prongs are properly plugged into the receptacle.
4. Return to your RV and turn "on" the load center main circuit breaker.

The shore line power cord should be unplugged when the recreation vehicle is left unattended. If something would happen to the electrical system, this may help limit potential damage.

When you are ready to leave, reverse the power cord connection process. Use care to prevent damaging the power cord electrical connection pins when connecting or disconnecting the shore line power cord. Grasp the plug to remove the power cord from the outlet; do not unplug it by pulling on the cord.

Maintenance

Inspect the power cord for cuts, cracks and worn insulation. Have the power cord replaced immediately if these symptoms are noticed.

WARNING

The power cord must be fully extended when in use and not left coiled in the electrical compartment or on the ground. If the power cord is left coiled, it may potentially create enough heat to melt its protective casing.

POWER CONVERTER

The power converter converts 120-volt AC power to useable 12-volt DC power when the shore power cord is connected to an external power source.

The converter has a built-in protective thermal breaker that will shut it down should overheating occur. Overheating can be caused by operating the converter above its maximum power output for an extended period of time, or by an obstruction to its ventilation air flow. To reduce converter heat build keep unnecessary 12-volt lights and motors turned “off”. Keep the converters cooling fins and fan clear of obstructions.

Red LED indicates blown fuse.

Absorption (Normal) Mode: 13.6VDC range. Batteries are being charged, just at a slower rate. Converter will not work without AC input

Float Trickle Mode: To get your converter into this mode reduce the load on the system to almost nothing but the battery. Let the system sit for approximately 44 hours. Converter voltage will drop to 13.2VDC. If the converter sees any load during this period or after it is in Float Mode it will revert back to Absorption (Normal) Mode. 13.6VDC.

Bulk Mode: Converter will not jump into the “Bulk Mode” unless the battery is below 50% of charge, or approximately below 13.2VDC output voltage. There is no way to force it to go into Bulk Mode.

- ❑ **USE ONLY A DEEP CYCLE BATTERY FOR RV USE.** Car batteries (CCA rating) are not designed for RV applications. If doing a lot of dry camping use a deep cycle battery rated in amp hours only. (NO CCA rating)
- ❑ If using multiple batteries they must be the same brand and type. Adding more batteries will provide longer use of DC appliances when not on shore power but may reduce charging efficiency.
- ❑ The battery works in conjunction with the converter to supply DC power to the RV. A battery is typically only necessary if you do a lot of dry camping or have slideouts and/or a leveling system.
- ❑ Reverse polarity fuse provides protection for the converter when a battery is used. If the battery is connected backwards to the fuse board this fuse would blow preventing damage to the converter.
- ❑ If your lights are dimming or flickering that usually indicates an overloaded converter. Remove some of the load by turning off DC lights or appliances.
- ❑ Fan is controlled by load. It will begin running at 3 to 6 amp DC draw. It increases in speed with a higher load until 14 to 15 amps. Fan is at maximum speed and stays there even with more load. If load drops below 6 amps DC, the fan shuts off.

SECTION 6: ELECTRICAL SYSTEMS

Inspection and maintenance

If the 12-volt power converter is not working (auxiliary battery not being charged) check the reverse polarity fuse(s) located on the end of the converter.

There are no customer serviceable parts inside the converter case and the manufacturer's warranty will be void if the case has been removed. If you have further concerns contact your dealer.



CAUTION

It is important that the fluid level of any connected batteries be checked on a regular basis. All batteries will "gas" and lose some fluid when continuously connected to any charging source (does not apply to "gel-cell" batteries).

For detailed information on operation and safety, refer to the manufacturer's owner's manual.

12-VOLT DC SYSTEM

The majority of your recreation vehicle lighting is powered by 12-volt electricity. The 12-volt DC system is composed of components that will operate when the following conditions are met:

- Power is supplied by the tow vehicle alternator when the engine is running and the 7-way trailer plug is connected. This powers the RV's running lights, brake lights, turn signals and brakes. In addition, the 7-way trailer plug provides a common ground and a 12-volt charge line to charge the auxiliary battery.
- The converter will supply interior 12-volt DC power when the power cord is plugged into campground power. The converter will also charge the RV battery in most situations. (Refer to *Battery Disconnect*)
- The auxiliary battery powers many interior 12-volt components including the lighting fixtures, water pump, 12-volt motors, 12-volt appliances, etc. It also powers the breakaway switch.

12-VOLT FUSE PANEL

The 12-volt fuse panel is labeled to indicate fuse sizes, positions and the components powered. At the beginning of camping season, inspect all the 12-volt fuses and replace as needed. Fuses are located in the Load Center

Replacing a fuse

Before replacing a fuse, always turn off electrical components protected by it.

1. Disconnect the shore power cord.
2. Disconnect the auxiliary battery main negative battery cable.
3. Remove the fuse panel cover to check fuses.
4. Pull the fuse straight out of the fuse block. If the fuse is not blown, something else must be causing the problem. Please contact your dealer for further assistance.
5. Insert a new fuse of the same specified voltage, amperage rating and type in the original location.

The fuse panel label should be kept permanently affixed to your recreation vehicle. Fuses will not offer complete protection of the electrical system in the event of a power surge or spike.

⚠ WARNING

Replacement fuses must be of the same voltage, amperage rating and type. Never use a higher rated replacement fuse; doing so may cause a fire by overheating the RV wiring.

12-VOLT DC OUTLET

There may be one or more 12-volt DC power outlets in your recreation vehicle. When the 12-volt DC outlet is used as a power source for an electric appliance, make sure the appliance operates on 12-volt DC power and that it consumes less than 60 watts (5 amps) of power.

⚠ WARNING

Keep the protective dust cap on the 12-volt DC outlet when not in use to prevent ingestion of foreign material and potential short circuit conditions.

AUXILIARY BATTERY (CUSTOMER SUPPLIED)

⚠ WARNING

Do not store anything inside the battery compartment(s) or near the batteries that could touch the battery or battery cable terminals. Contact with the battery or battery cable terminals could cause an electrical short circuit, discharge the batteries, or start an electrical fire.

The combined 12-volt DC loads in your recreation vehicle become more than the converter can produce. This demand can be met by using an auxiliary battery for a limited period of time. The 12-volt system is designed for usage with a Group 27, deep cycle battery.

Dry camping

The auxiliary battery should be fully charged prior to dry camping. If the auxiliary battery is not being recharged and power is being drawn from it, it will eventually discharge. A battery will discharge at a faster rate as its energy level becomes depleted. Plan your electrical usage accordingly. You can test the auxiliary battery voltage using a volt-ohm meter (customer supplied).

A fully charged auxiliary battery will read 12.7 volts DC and 1.265 specific gravity at 80°F (32°C). The auxiliary battery is considered discharged at 11.89 volts, and dead at 11.65 volts. If the voltage drops below those levels, irreversible damage can occur. Typically, a deep cycle battery has an amp-hour rating of 75-100 amps.

If you run the furnace and refrigerator simultaneously, you will be using approximately (12.0 + 3.0) 15.0 amps per hour. This does not include any 12-volt lights, or any other 12-volt component. If the furnace and refrigerator in this example operated constantly, a 75 amp-hour battery would become fully discharged in 5 hours (75ah / 15a = 5h).

The auxiliary battery should be installed in parallel with the battery in your tow vehicle. When the 7-way trailer plug is connected, both batteries power the RV. Do not allow it to discharge your tow vehicle battery below the level required to start the engine. To prevent

SECTION 6: ELECTRICAL SYSTEMS

this from occurring, disconnect the 7-way trailer plug or install a battery isolator. When the tow vehicle engine is operating with the RV connected, the tow vehicle charging system will charge both batteries.

Replacement and maintenance

Some equipment in your RV will draw small amounts of current even when turned OFF. To prevent the auxiliary battery from being discharged when your RV is not connected to shore line power, disconnect the auxiliary battery negative cable at the battery. During storage, it is important to check the voltage monthly and recharge the auxiliary battery as needed. If you remove the auxiliary battery from your RV, store it in a dry, cool area per the manufacturer's instructions.

When it is time to replace the auxiliary battery, **replace it with a Group 27 deep cycle battery only**. Do not reverse the positive and negative battery cables (doing so will blow the reverse polarity fuse(s) that protect the converter).

WARNING

Keep sparks, cigarettes and flames away from the batteries as the hydrogen gas they create may explode. Do not connect a booster battery or other power source that outputs more than 14.2-volts DC to the motor home batteries. Use adequate ventilation when charging or using batteries in an enclosed space. Remove metal jewelry and always wear eye protection when working around batteries.

WARNING

Do not allow battery electrolyte (acid) to come into contact with skin, eyes, fabric or painted surfaces. Electrolyte is a sulfuric acid solution that could cause serious personal injury or property damage. If your hands, eyes, clothes or the painted surface of your motor home are exposed to electrolyte, flush the exposed area thoroughly with water. If electrolyte gets in your eyes, immediately flush them thoroughly with water and get prompt medical attention.

For more information

Please contact the battery manufacturer for additional information on the auxiliary batteries.

BATTERY ISOLATOR FOR YOUR TOW VEHICLE (CUSTOMER SUPPLIED)

You may want to consider the installation of a battery isolator on your tow vehicle as a convenience feature:

- It receives current from the tow vehicle alternator and controls distribution of energy to both the RV auxiliary battery and the tow vehicle battery.
- It serves as a check valve to prevent energy from being drawn from your tow vehicle chassis battery (so you can start your tow vehicle engine).

Your dealer can assist you with the selection, purchase and installation of this aftermarket part. than 60 watts (5 amps) of 12-volt power. To prevent short circuits do not allow metallic foreign matter to get into the 12-volt DC outlet.

LOAD CENTER

The Load Center contains 12VDC fuses and 120VAC circuit breakers for almost all of the electrical appliances and circuits in the RV. The 120V Main Breaker (if so equipped) is located in this panel and will turn off all 120-volt power to the recreation vehicle. The load center is a hinged panel typically attached to a cabinet face in the main living area. Locations will vary by model. Refer to the diagram inside the Load Center for specific fuse assignments. Most load centers contain the same components, but they may be positioned differently. Not all load centers will include a main breaker.

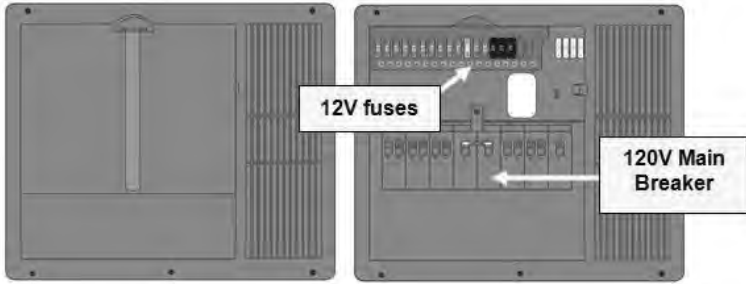

Typical Load Center Exterior Panel

Load Center Panel w/120 volt Main breaker – load center appearance and configuration may vary by model

APPROXIMATE ELECTRICAL LOAD RATINGS

12 Volt System	
Aisle Lights	1.0 AMP
Baggage Compartment Lights	1.4 AMPS
Decorative Wall Lights	1.5 AMPS
Dinette Light	4.5 AMPS
Exterior Entertainment Center	5-7 AMPS
Fantastic Fan	1.5 AMPS
Fluorescent Double Lights -12"	2.0 AMPS
Fluorescent Double Lights -18"	2.5 AMPS
Furnace	12.0 AMPS
Generator Start	95.0 AMPS*
Halogen Light	1.7 AMPS
Illuminated Switch	.125 AMP
Inverter	variable
Leveling System	95.0 AMPS*
LP Detector	.125 AMP
Map Light	1.5 AMPS
Porch Light	1.5 AMPS
Power Awning	10.0 AMPS
Power Vent	5.0 AMPS
Refrigerator	3.0 AMPS
Shower Light	1.4 AMPS
Step Cover	10.0 AMPS
TV Plate/Antenna Booster	1.0 AMP
Vanity Light	4.2 AMPS

SECTION 6: ELECTRICAL SYSTEMS

Water Heater	6.0 AMPS
Water Pump	7.0 AMPS

*Momentary Load

12 Volts: Labeled watts divided by 12 = Power consumed in AMPS

120 Volt System	
Air Conditioner	18 AMPS
Coffee Maker	6-12 AMPS
Converter (each)	8 AMPS
DVD System	3 AMPS
Fireplace	12 AMPS
Hair Dryer or Curling Iron	10-14 AMPS
Microwave	12 AMPS
Refrigerator	6 AMPS
Satellite Receiver	2 AMPS
TV	2-4 AMPS
Vacuum Cleaner	8 AMPS
Washer/Dryer	12 AMPS
Water Heater	12 AMPS

120 Volts: Labeled watts divided by 120 = Power consumed in AMPS

120-VOLT (30 AMP) AC SYSTEM (IF SO EQUIPPED)

The 30 amp 120-volt 60hz AC electrical system is designed to operate on 1 leg of 120-volt power at a maximum current flow of 30 amperes.

Exposure to voltages higher or lower than a nominal 120-volts will damage or shorten the service life of the electrical system and appliances. The 30 amp 120-volt 60hz AC electrical system can be powered by the 120-volt 60hz utilities found in RV campgrounds or by 120-volt 60hz generator power.

The following electrical components will only operate when your motorhome is connected to shore or generator power: 120 to 12-volt power converter, air conditioner, refrigerator, microwave oven, television(s), home theater system(s), electric water heater, washer, dryer, fireplace, and appliances plugged into convenience receptacles.

WARNING

Make certain the external power source you connect the power cord to is a properly wired **30 amp NEMA TT-30** RV receptacle and not 240 volt AC.

WARNING

Circuit breakers and fuses will not offer complete protection of the electrical system in the event of power surge or voltage spike.

30-AMP POWER CORD (IF SO EQUIPPED)

⚠ WARNING

PLUG INTO 30-AMP SERVICE ONLY.

The 30 amp external utility power cord is commonly referred to as the “shore” power cord. It is designed to mate and properly function with 30 amp “shore” power receptacles available at most campgrounds.

The shore power cord is designed to continuously carry the 30 amp current flow required to power each leg of the electrical system. It also creates a critical ground connection between the vehicle electrical system and the campground shore power receptacle.

CALCULATING 30 AMP ELECTRICAL LOAD (IF SO EQUIPPED)

When connecting appliances to the electrical system, remember that 120-volt power usage is limited to a total of 30 amps. Be mindful of the fact that each operating appliance collectively places an added load on your 120-volt electrical system.

An unintentional “trip” of a circuit breaker may occur if you overload the recreation vehicle and/or campground electrical system. The amperage rating of individual appliances can be calculated by dividing appliance wattage consumed (normally listed on the appliance) by nominal design voltage (120 for a 120-volt appliance). For example: 1200 watts divided by 120-volts equals 10 amps.

Only connect the shore power cord to properly wired 30 amp NEMA TT30 120 volt power receptacles.

⚠ WARNING

- Do not hook up the power cord to any receptacle until you have verified proper polarity and grounding. Polarity indicators can be purchased in most electrical and hardware stores.
- Do not use any cheater plug, adapter or extension cord to reconfigure incoming AC power or break the continuity of the circuit connected to the grounding pin.
- Do not connect the power cord into an outlet that is not grounded, or adapt the power cord plug to connect it to a receptacle for which it is not designed.
- Do not remove the grounding pin to connect to a non-grounded receptacle. Removal of the ground pin disables an important safety feature designed to prevent shock and electrocution hazards.
- Do not connect the power cord to an extension cord. Use of an improper extension cord will cause overheating of the cord as well as potentially causing premature failure of the AC equipment.

It is the responsibility of the owner of the electrical receptacle to ensure that the receptacle is properly wired and grounded. Reverse polarity and/or improper grounding of your recreation vehicle can cause personal injury or death.

CALCULATING 50 AMP ELECTRICAL LOAD (IF SO EQUIPPED)

When connecting appliances to the electrical system, remember that 120-volt power usage is limited to 50 amps per electrical system leg for a total of 100 amps. Be mindful of the fact that each operating appliance collectively places an added load on your 120-volt electrical system.

An unintentional “trip” of a circuit breaker may occur if you overload the recreation vehicle and/or campground electrical system. The amperage rating of individual appliances can be calculated by dividing appliance wattage consumed (normally listed on the appliance) by nominal design voltage (120 for a 120-volt appliance). For example: 1200 watts divided by 120-volts equals 10 amps.

Only connect the shore power cord to RV 50 amp 120/240 volt electrical power receptacles.

WARNING

- Do not hook up the power cord to any receptacle until you have verified proper polarity and grounding. Polarity indicators can be purchased in most electrical and hardware stores.
- Do not use any cheater plug, adapter or extension cord to reconfigure incoming AC power or break the continuity of the circuit connected to the grounding pin.
- Do not connect the power cord into an outlet that is not grounded, or adapt the power cord plug to connect it to a receptacle for which it is not designed.
- Do not remove the grounding pin to connect to a non-grounded receptacle. Removal of the ground pin disables an important safety feature designed to prevent shock and electrocution hazards.
- Do not connect the power cord to an extension cord. Use of an improper extension cord will cause overheating of the cord as well as potentially causing premature failure of the AC equipment.

It is the responsibility of the owner of the electrical receptacle to ensure that the receptacle is properly wired and grounded. Reverse polarity and/or improper grounding of your recreation vehicle can cause personal injury or death.

120-VOLT CIRCUIT BREAKERS

The 120-volt AC circuit breakers located inside the load center protect all 120-volt wiring and components in the recreation vehicle from circuit overloads and short circuits. Should a circuit overload or short circuit occur the circuit breaker protecting the affected circuit will “trip” preventing the flow of electricity through that circuit.

If a circuit breaker trips, shut “off” the appliance on that circuit (i.e., power converter etc.) and allow the circuit breaker to cool down for a brief period of time. After the cooling down period, reset the circuit breaker by moving its lever “off” and then back to the “on” position. If the circuit breaker re-trips or frequently trips, contact your dealer to have the electrical problem diagnosed and repaired.

A circuit breaker identification label is permanently attached to the inside surface of the 120-volt Load Center. 120-volt circuit breakers are located in the sub-panels inside the cabinet above the driver seat.



NOTE: Load Centers may not always include a main circuit breaker.



CAUTION

Circuit breakers and fuses will not offer complete protection of the electrical system in the event of power surge or voltage spike.

Replacement

Only replace circuit breakers with those of the same specified type, voltage, and current rating. **Never replace a circuit breaker with one listed at a higher amperage rating.** Please contact your dealer for repair assistance when replacing circuit breakers.



WARNING

Replacement circuit breakers must be of the same voltage, amperage rating and type. Never use a higher rated replacement circuit breaker; doing so may cause a fire by overheating the RV wiring.

Maintenance

At the beginning of camping season, inspect the circuit breakers and replace as needed. Test by turning each circuit breaker “off” and back “on”. Circuit breakers are wearable parts and must be replaced as needed, as part of your RV maintenance. If you have any questions, consult your dealer.

A label is provided to explain the function of every 120-volt circuit breaker. This label is located on or near the appropriate load center or sub-panel and must remain permanently affixed to the recreation vehicle.

SOLAR PREP (If So Equipped)

Your recreation vehicle may be wired with a (exterior) plug in that will allow the batteries to be trickle charged using a free standing solar panel. In most models, the solar panel kit is a customer purchased and installed option. The solar plug location will vary by model, but may be located either on the sidewall, on the A-frame of the vehicle or in the outside utility center. There are capped off wires located in the area of the battery. These wires are the battery charging wires. Once these wires are properly connected to your battery, you will then be able to plug the solar panel into the charging port.



Solar Plug

When the system is connected properly, the solar panel will supply power to the battery, the battery will supply power to the converter, and the converter will supply power to all the 12V systems as needed.

SECTION 6: ELECTRICAL SYSTEMS

REPLACING LIGHT BULBS

Before replacing a bulb, be sure the light is off. Do not touch the glass part of the new bulb with your bare fingers. The skin oil left on the glass will evaporate when the bulb gets hot, the vapor will condense on the reflector and it will dim the surface.

Replacement light bulbs must be of the type, voltage and wattage listed on the lamp fixture. Use of incorrectly sized bulbs can overload lam circuits and may create a fire hazard by overheating the fixture.

EXHAUST GAS FUMES

⚠ WARNING

Avoid inhaling exhaust gases as they contain carbon monoxide, which is a potentially toxic gas that is colorless and odorless.

⚠ WARNING

If you are in a recreation vehicle with either a nearby tow vehicle engine running or the generator (if so equipped) running there is a potential for exhaust fumes to filter back into the recreation vehicle.

To avoid breathing exhaust gases, follow these precautions:

- ❑ Always shut OFF the tow vehicle engine, generator engine (if applicable), etc., while refueling.
- ❑ Do not run the tow vehicle engine, generator engine (if applicable), etc., in confined areas, such as a closed garage, any longer than needed to move your RV in or out of the area.
- ❑ Windows should be closed while driving or running the generator (if so equipped) to avoid drawing dangerous exhaust gases into the RV.
- ❑ If you suspect that exhaust fumes are entering the RV have the cause determined and corrected as soon as possible.

The best protection against carbon monoxide entry into the RV is a properly maintained ventilation system and an active carbon monoxide detector. To allow for proper operation of the RV ventilation system, keep the ventilation inlet grill(s) clear of snow, leaves or other obstructions at all times.

See the *Occupant Safety* section of this manual for additional information on carbon monoxide safety.

PROPANE GAS SYSTEM

Propane or LP (liquefied petroleum) gas is a clean and efficient form of energy when proper handling and safety precautions are observed. The propane system in your recreation vehicle furnishes the fuel for cooking, heating and hot water. Propane can also be used as an alternative energy source for refrigeration

The propane fuel system is comprised of numerous components such as the propane container, hoses, the propane gas regulator, piping and copper tubing lines to each appliance.

Propane is heavier than air; the gas tends to flow to lower areas and will sometimes pocket in these low areas, such as the floor. Your recreation vehicle is equipped with a propane alarm (refer to the *Safety Precaution sections*, Combination Carbon Monoxide (CO)/Propane Alarm.)

SECTION 7: FUEL & PROPANE SYSTEMS

WARNING

Propane cylinders should not be placed or stored inside RV. LP-gas cylinders are equipped with safety devices that relieve pressure by discharging gas into the atmosphere.

Maintenance

Although your recreation vehicle has been carefully tested at the factory, and by your selling dealer for leakage, travel vibrations can loosen fittings. Have the propane system checked at all connections soon after the purchase of your recreation vehicle, and after the initial filling of the propane tanks.



NOTE: All propane lines have been checked with air pressure at the time of manufacture. Dealers are required to recheck and adjust pressure before retail delivery.

Continued periodic checks of the propane system at 5,000 miles of travel (or at least once a year), by a qualified propane service representative as part of your normal maintenance is recommended. Hand tighten the LP gas system valves only, do not use a wrench or pliers as over tightening may damage the valve seals and cause them to leak.

PROPANE LEAK TEST

Leaks may be found easily with a soapy water solution. Do not use a solution containing ammonia or chlorine when locating leaks. These products are corrosive to copper gas lines and brass fittings, which could result in deterioration of the copper and brass components.

Apply the soapy solution to the outside of the gas piping fittings. If a leak is present, the soapy solution will “bubble” at the leak point. If a leak is indicated, shut off the propane system valve(s) and contact an independent Entegra dealer or qualified propane service representative immediately.

DANGER

Never use an open flame to test for a propane leak. Do not check for leaks using products that contain ammonia or chlorine; these products can cause cracks to form on the metal tubing and brass fittings

PROPANE SAFETY PROCEDURE

Propane is a colorless and odorless gas that, in the liquefied state, resembles water. An odorant (usually a sulfur compound) is added as a warning agent. If you smell propane within the vehicle, quickly and carefully perform the procedure listed on the label below.

This label has been placed in the vehicle near the range, for models equipped with a propane system

▲ DANGER

IF YOU SMELL PROPANE

1. Extinguish any open flames, pilot lights and all smoking materials.
2. Shut off the propane supply at the container valve(s) or propane supply connection.
3. Do not touch electrical switches.
4. Open doors and other ventilating openings.
5. Leave the area until odor clears.
6. Have the propane system checked and leakage source corrected before using again.

Ignition of flammable vapors could lead to a fire or explosion and result death of serious injury.

Propane system label

When propane container is low, occasionally there may be a concentration of an onion or garlic-like odor, which can be mistaken for a propane gas leak. After the propane container has been refueled, the odor will usually disappear. If not, turn off the valve(s) and have the propane system inspected by your dealer or qualified propane service representative.

PROPANE GAS CONTAINER

Propane “container” is a general all inclusive term used to describe a vessel that is used for storage and delivery of propane gas. The most common of these are:

DOT (Department of Transportation) cylinders are transportable and are commonly used on recreation vehicles. The capacity of DOT propane cylinders is expressed in pounds. DOT propane cylinders are required to be removed from the recreation vehicle for filling and must be filled by weight by a qualified propane facility. DOT Propane cylinders are equipped with an OPD or Over Fill Protection Device designed to reduce the potential of overfilling. DOT propane cylinders are also equipped with an ACME service valve that is for connection of the TYPE 1 ACME pigtail hose assembly to the RV two-stage regulator.

The TYPE 1 ACME pigtail hose assembly is a wrenchless, user friendly, right hand threaded connector that features a thermally sensitive sleeve and excess flow device. Max output is 200,000 BTU/hr. It is used to connect propane cylinders to regulators, hoses and other fittings. It is not for use on gas grills and other low pressure devices. DOT cylinders equipped with an OPD and ACME type 1 service valve are identified by the triangular service valve knob.

DOT cylinders are typically marked with “top” or an arrow to indicate the correct orientation of the cylinder(s). Do not mount, store or transport any cylinder other than the in proper position indicated.

Be sure to securely re-install DOT cylinder(s) to the recreation vehicle after they have been removed for filling or replacement. Always close the service valve and install a dust cap or plug when transporting or storing disconnected containers whether full or empty.

ASME tanks are permanently mounted to the RV and are commonly used on RV motor homes.

The capacity of ASME tanks is expressed in gallons. ASME tanks are filled while the tank is attached to the motor home by a qualified propane facility. ASME tanks are equipped with an automatic stop fill valve designed to reduce the potential of overfilling. ASME propane tanks are also equipped with a P.O.L. service valve that is for connection of the supply hose with a left hand threaded brass P.O.L. fitting from the tank service valve to the two-stage regulator. Not for use on gas grills and other low pressure devices.

SECTION 7: FUEL & PROPANE SYSTEMS

WARNING

DOT propane cylinders must be transported and stored in an upright position so the pressure relief device will function properly. Laying a DOT propane cylinder on its side may potentially create a very dangerous situation.

NOTE: Tanks are to be installed, fueled and maintained in accordance to State and Local codes, rules, regulations or laws.

Propane is a true gas compressed into a liquid form. As the fuel is released from the container, it changes to vapor which is then used for the operation of the appliances. Propane will not run through the appliances in the liquid state.

Propane expands 1½ percent for every ten degrees of increase in temperature. It is imperative to leave sufficient space inside the container to allow for natural expansion of gas during warmer weather.

The main shut off valve must be kept closed at all times unless you are using the propane system or filling the propane cylinder. When the cylinder is disconnected from the hose, install the valve cover that is attached to the container.

Close the propane cylinder main shut off valve by hand tightening only. Use of tools creates a potential to over tighten the valve (damaging the interior seals on the cylinder valve seat). If this type of damage occurs, the cylinder will not close properly.

The following label should be kept permanently affixed to your RV.

WARNING

THIS SYSTEM IS DESIGNED FOR USE WITH PROPANE ONLY.
DO NOT CONNECT NATURAL GAS TO THIS SYSTEM.

BEFORE TURNING ON PROPANE:

- (1) BE SURE ALL APPLIANCES ARE CERTIFIED FOR PROPANE AND ARE EQUIPPED WITH CORRECT BURNER ORIFICES.
- (2) MAKE SURE ALL PROPANE CONNECTIONS ARE TIGHT BY TESTING WITH SOAPY WATER. ALL APPLIANCE VALVES ARE TURNED OFF, AND ANY UNCONNECTED HOSES ARE CAPPED.

AFTER TURNING ON PROPANE:

- (1) LIGHT ALL PILOTS.
- (2) ALL CONNECTIONS, INCLUDING THOSE AT THE APPLIANCE, REGULATOR AND CYLINDER, SHOULD BE LEAK-TESTED PERIODICALLY WITH SOAPY WATER BY THE OCCUPANT. NEVER USE A LIGHTER MATCH OR OTHER FLAME WHEN CHECKING FOR LEAKS.
- (3) DO NOT LEAVE SYSTEM TURNED ON IF CONTAINER IS CONNECTED UNTIL THE SYSTEM HAS BEEN PROVEN TO BE FREE OF ANY LEAKS.
- (4) COOKING APPLIANCES SHOULD NOT BE USED FOR SPACE HEATING.
- (5) WHEN THE CONTAINER AND DISCONNECTED, THE PROPANE SUPPLY LINE SHOULD BE CAPPED OR PLUGGED.

AVERTISSEMENT

NE PAS L'ALIMENTER EN GAZ NATUREL.

AVANT LA MISE EN SERVICE:

- (1) S'ASSURER QUE LES APPAREILS SONT CERTIFIES POUR LE PROPANE ET MUNIT D'ORIFICES DE BRULURE APPROPRIES.
- (2) VÉRIFIER L'ÉTANCHÉITÉ DE TOUTES LES RACCORDEMENTS AU PROPANE, LA FERMETURE DE TOUTES LES ROBINETS D'APPAREILS ET LA CONFIGURATION DE TOUTES LES BOITES NON-ÉCHAPÉES.

APRÈS LA MISE EN SERVICE:

- (1) ALLUMER TOUTES LES VÉLÉANCES.
- (2) L'OCCUPANT DOIT ÉPREUVER PÉRIODIQUEMENT L'ÉTANCHÉITÉ DE TOUTES LES RACCORDEMENTS, Y COMPRIS CELUX AUX APPAREILS, AINSI QUE LES BRULURES ET AUX BOITES NON-ÉCHAPÉES, EN Y APPLIQUANT DE L'EAU SAVONNEUSE. NE JAMAIS SE SERVIR D'UNE ALLUMETTE OU D'AUTRES FLAMMES POUR LA DÉTECTION DES FUITES.
- (3) NE PAS LAISSER L'ALIMENTATION OUVERTE, NI LES RÉCHAUFEURS RACCORDEMENT À AUTRES COMPLEXES D'ÉCHAUFFEMENT, ET S'ILS SONT EN ALIMENTATION, NE PAS INSTALLER.
- (4) LES APPAREILS DE CUISINE NE DOIVENT PAS ÊTRE UTILISÉS POUR LE CHAUFFAGE DES LOCAUX.
- (5) LORSQU'ILS LES RÉCHAUFEURS SONT DÉCONNECTÉS, L'ALIMENTATION DE PROPANE DOIT ÊTRE FERMÉE OU BLOQUÉE.

“Use propane only” label (Canada only)

(Label appearance may not be exact)

Servicing or filling

Have the recreation vehicle checked for leaks at the connections on the propane system soon after the purchase and the initial filling of each propane cylinder. When you have a new cylinder filled for the first time, make sure your propane supplier purges your new cylinder of trapped air. Otherwise, an improper mixture of gas and air will make it impossible to light your propane appliances.

SECTION 7: FUEL & PROPANE SYSTEMS

No one should be inside and only the qualified propane service technician should be near the RV while the propane tank is being filled. The new propane container must be carefully purged for best performance and must **NEVER BE OVERFILLED**. The following label should be kept permanently affixed to your RV.

⚠ WARNING

Before entering a propane or fuel service station make sure all pilot lights are extinguished. Shut off gas to all appliances by closing the propane gas main shut off valve. Always shut OFF any engine before refueling. Do not smoke and do not operate other ignition sources while refueling.

⚠ DANGER

ALL PILOT LIGHTS, APPLIANCES AND THEIR IGNITORS (SEE OPERATING INSTRUCTIONS) SHALL BE TURNED OFF BEFORE REFUELING OF MOTOR FUEL TANKS AND/OR PROPANE CONTAINERS. FAILURE TO COMPLY COULD RESULT IN DEATH OR SERIOUS INJURY. AD-05

“Shut off for re-fueling” label
(Label appearance may not be exact)

The position of the propane container(s) and the hoses are critical to proper operation and propane flow. Follow these instructions to make sure your propane container(s) are connected properly.

⚠ WARNING

The pigtail hose must be installed to avoid tension or pulling stress at either end of the hose. Keep the pigtail hose away from sharp edges of the cylinder collar, rigid corners, walls, doors or other compartment structures including the cover.

LP gas container overfill

Never allow your propane tank to be filled above the maximum safe level as indicated by the fixed liquid level gauge. Do not allow the visible gauge to be used for filling. Overfilling the propane container above the liquid capacity indicated on the container, could allow liquid propane to enter the system that is designed for vapor only creating a hazardous condition.

⚠ WARNING

If you suspect your propane container has been overfilled, contact your independent Jayco dealer or a qualified propane technician for assistance immediately. Do not attempt to service a propane container overfill yourself.

SECTION 7: FUEL & PROPANE SYSTEMS

The following label should be kept permanently affixed to your RV.



“Do not fill to more than 80%” label

(Label appearance may not be exact)

Refer to your Warranty Packet for more information on the LP gas system components.

INSTALLING PROPANE CYLINDER(S)

⚠ WARNING

Ensure that all fasteners are secured before traveling.

Single Cylinder Mounted On A-Frame (if so equipped)

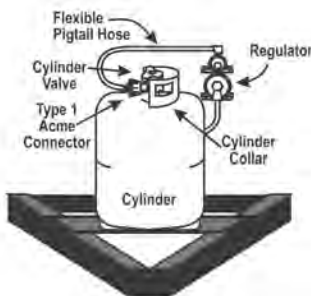

Single Cylinder

1. Connect the 3/8” low pressure hose to the outlet of the two stage regulator.
2. Attach the regulator with the “Z” bracket on the center of the front wall with the vent pointing down.
3. Attach the protective plastic cover to the regulator.
4. The regulator has a 90° elbow that directs the inlet toward the trailer curbside.
5. Place the cylinder on the bracket provided on the A-frame and position it so the outlet of the cylinder valve is pointed directly outward to the curbside wall.
6. If a vinyl cylinder cover is provided, slip it over the cylinder and leave the zipper open (if so equipped).
7. Attach the 1/4” inverted flare x 24” Type 1 pigtail hose to the regulator inlet and the right hand swivel nut to the cylinder valve.
8. If applicable, close the cylinder cover zipper (if so equipped) up to the hose.
9. Secure the cylinder to the A-frame bracket using the bolts, nuts and washers provided.

Double Cylinder Mounted On A-Frame (if so equipped)

When a second cylinder is installed, a tee check valve is used to replace the 90° elbow at

the top of the regulator and another 1/4" inverted flare x 24" Type 1 pigtail is added. The regulator stays in the original position.

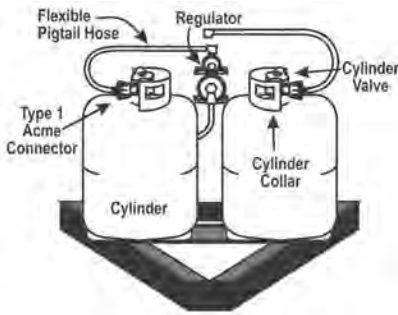

Double Cylinder

1. Place the second cylinder on the A-frame bracket so the cylinder valve is pointed to the roadside of the folding camping trailer.
2. Secure the second cylinder to the A-frame using the bolts, nuts and washers provided.
3. If a vinyl cylinder cover is used, slip it over the new single cylinder, or a double cylinder cover may be used in lieu of single covers.
4. Attach the second 24" hose to the tee check valve on the regulator and the right handed swivel nut to the cylinder valve.

Maintenance

Propane gas is normally non-corrosive - you need not worry about the inside of your container. However, the outside should be kept free from rust by a periodic coat of paint in a light reflective color. Rust, scratches and/or dents can affect the safety of the cylinder. Inspect the cylinder at regular intervals.

If there is a problem, have it evaluated by a qualified technician and discard it. DOT requires that a visual inspection be made prior to each filling.

Any cylinder that has been exposed to fire, leaks or seems damaged should not be refilled.

Do not attempt to repair any containers, container valves, regulator or appliances by yourself. Use only trained certified propane gas service technicians to perform repairs.

Propane cylinder recertification

If you have an older RV you should know that, according to Federal law, DOT cylinders may only be used for 12 years after their manufacture date (the number of years for certification may vary in your area). After that, the cylinders must be "recertified" which provides another five years of use.

The cylinders can be recertified every five years thereafter. Federal DOT (Department of Transportation) regulations require periodic inspections and re-qualifications of the propane cylinders. **DO NOT USE** damaged or rusted containers.

Verify with your local propane dealer that all required inspections and certifications have been completed on the propane cylinder within the correct time period before refilling the cylinder.

Have the LP system checked for leakage each time a cylinder is refilled or after any part of the propane system has been disconnected.

Hoses, Pipes, Tubes & Fittings

The hoses, pipes, tubes and fittings used in your propane system are designed to withstand

SECTION 7: FUEL & PROPANE SYSTEMS

pressures exceeding those of the propane system. However, because environment and time can both contribute to the deterioration of these components, they must be inspected for wear at regular intervals.

Be sure to inspect the hose before each season and when having the tank refilled. Look for signs of deterioration such as cracks or loss of flexibility. When replacing the hose or other propane components, make sure to always replace them with components of the same type and rating (check with your dealer).

Fittings are used to connect the various system components to each other. The P.O.L. fitting at the end of the propane supply hose is made of brass so that pipe sealants are not necessary to prevent leaking.

It also has a left-handed thread, which means that it is turned clockwise to remove, and counter-clockwise to tighten. The P.O.L. fitting has been designed to help restrict the flow of LP gas in the event of a regulator failure or hose malfunction.

PROPANE REGULATOR

WARNING

Propane regulators must always be installed with the regulator vent facing downward. Regulators that are not located in baggage compartments have been equipped with a protective cover. Make sure the regulator vent faces downward and (if applicable) the cover is in place to minimize vent blockage that could result in excessive gas pressure causing fire or explosion.

Single stage regulator

Some models are equipped with a single stage regulator.

Two stage regulator

The two-stage regulator has the only moving components in the propane system. Its sole function is to reduce the pressure from the propane containers to a safe and consistent low operating pressure. The first stage reduces the container pressure to 10-13 lbs. The second stage reduces the 10-13 lbs. of pressure further to an operating pressure of 11" W.C. (water column) or 6.35 oz. of outlet pressure to your appliances.

The second stage is adjustable and will need to be adjusted by your dealer or qualified propane service technician for optimum performance (this adjustment should always be made with a properly calibrated manometer).

If the pressure is too high, it affects performance and safety; if the pressure is too low, your appliances will not operate correctly.

If your recreation vehicle is equipped with the "automatic" two-stage regulator, with both cylinders full of propane, turn the lever on the regulator towards the cylinder you wish to use first. This will now be the "supply" cylinder and the other the "reserve." Slowly open both cylinder valves. The indicator on top of the regulator will turn bright green. When the cylinder becomes empty, the indicator will change to bright orange. Now turn the regulator lever to the side of the "reserve" cylinder and the green signal should return. You may now remove the empty cylinder to have it refilled without interrupting the flow from the full bottle. After filling the cylinder, connect the pigtail hose and slowly open the bottle valve.

USING THE PROPANE SYSTEM

After your recreation vehicle is completely set up use the following steps for propane operation:

1. Close ALL burner valves, controls and pilot light valves.
2. Open the main valve in the propane tank slowly to avoid a fast rush of propane vapor through the excess flow valve causing propane “freeze-up.” Should you experience propane “freeze-up,” close the main valve and wait 15 minutes before trying again.
3. Listen carefully as propane begins to flow. If a hissing noise is heard for more than one or two seconds, close the main valve and contact your recreation vehicle dealer to have the propane system tested.
4. Light the appliances as needed and directed in the appropriate appliance manufacturer’s owner manual located in the Warranty Packet.

Keep the propane container valves closed at all times unless you are using the propane gas system or are having the propane container filled.

Make sure that you read and fully understand ALL safety requirements for handling and operation of the propane system.

The Warranty Packet contains manufacturer’s user guides for the various appliances hooked to your propane system.

The propane system provides added benefits to your camping enjoyment; however, it must be handled with care. If you have any questions or concerns, consult with your dealer and/or the specific manufacturer.

If you have double cylinders on your recreation vehicle, use only one at a time. Otherwise, the propane supply will be drawn equally from both cylinders until the supply has been totally exhausted. Using one cylinder until it is empty, then using the second cylinder will allow you to fill the empty cylinder at your convenience without running totally out of propane.

CALCULATING PROPANE GAS USAGE

It is important to remember that your furnace, refrigerator, water heater and range all may use propane gas to operate. Each has a different BTU rating, and you will need to consider them to determine how long your propane supply will last. Most RV gas appliances are operated intermittently. Propane consumption depends on individual use of appliances and the length of time operated. Unless there is heavy use of hot water, the water heater consumption of propane is minimal. During cool temperature or high wind conditions, furnace consumption can be extremely high.

To calculate your propane supply, take the BTU ratings for your propane appliances and divide that into the BTU availability. Each gallon of propane gas (3.785 liters) produces about 91,500 BTU’s (96,528 kilojoules) of heat energy.

SECTION 7: FUEL & PROPANE SYSTEMS

Propane consumption chart

The following chart provides average propane consumption information.

Appliance	Average BTU Consumption per Hour	Kilojoules/Hour
Water Heater	8,800	9,280
Refrigerator	1,200 – 1,500	1,270 – 1,580
Furnace	35,000 – 40,000	36,930 – 42,200
Range/oven	7,100	7,490
Range, rear burner	6,500	6,860
Range, front burner	9,000	9,490
Outside Grill	10,000	10,550

COOKING WITH PROPANE GAS

⚠ WARNING

Do not turn gas range burner controls to ON and allow gas to escape before lighting.

⚠ WARNING

Do not use portable fuel burning equipment (i.e., wood and charcoal grills or stoves) inside the recreation vehicle.

Unlike homes, the amount of oxygen supply is limited due to the size of the recreation vehicle. Proper ventilation when using the cooking appliance(s) will help you avoid the danger of asphyxiation.

It is especially important that cooking appliances not be used for comfort heating, as the danger of asphyxiation is greater when the appliance is used for long periods of time. FAILURE TO COMPLY MAY RESULT IN DEATH OR SERIOUS INJURY.

The following warning labels are located in the cooking area to remind the user to provide an adequate supply of fresh air for combustion.



Ensure a supply of fresh air (Canada units only)



Cooking / comfort heating label

TRAVELING WITH PROPANE

Use care when fueling your tow vehicle. Make certain your propane container is properly fastened in place.

Some states prohibit propane appliances to be operated during travel, especially in underground tunnels. Make sure you know the laws for the areas where you travel.

The label listed below should be kept permanently affixed to your recreation vehicle:



Re-fueling Warning Label

SECTION 7: FUEL & PROPANE SYSTEMS

Notes:

There are two different water systems in your recreation vehicle:

- The fresh water system consists of the fresh water holding tank, fresh water connections, water pump, outside shower assembly (if so equipped), water heater, faucets, tub/shower, and water purification system (if so equipped).
- The waste water system consists of the waste water holding tank, sewage holding tank, drains and toilet.

PLUMBING SYSTEM MAINTENANCE

- Check all fittings, pressure and waste, for leaks before each trip or before vehicle storage as part of your normal maintenance:
- Inspect all faucets, the water purification system (optional) and sink connections (including drain baskets or filters).
- Inspect connections at the water pump and water heater.
- At the end of every trip, you should drain any unused water from the fresh water system. All water contains contaminant and mineral particles that can cause fresh water system odors. Untreated well water is a major source of water system odors.
- The fresh water (or potable water) system needs periodic sanitization and winterization to take care of all the components within the plumbing system and help discourage the growth of bacteria and other organisms that can contaminate the water supply.

Typically, there are labels affixed to the exterior of the recreation vehicle sidewall that indicate the locations of the water system drains and fills. Be aware some drain valves may be located inside the vehicle (once the exterior label is found, go inside to find the drain corresponding location).

MONITOR PANEL (IF SO EQUIPPED)

Depending on your model, the monitor panel may be located on the Command Center panel, on an interior wall, or on the exterior utility center. The monitor panel allows you to monitor the fresh water, grey water, black water and auxiliary battery levels. These functions are controlled using the “tact” switches located on the monitor panel faceplate. The monitor panel operates on 12-volt DC power supplied by either the converter or auxiliary battery. No power is drawn from the battery unless a switch is pushed or turned ON. Fuses for the monitor panel are located in the load center. Refer to the manufacturer’s operators manual for additional information.

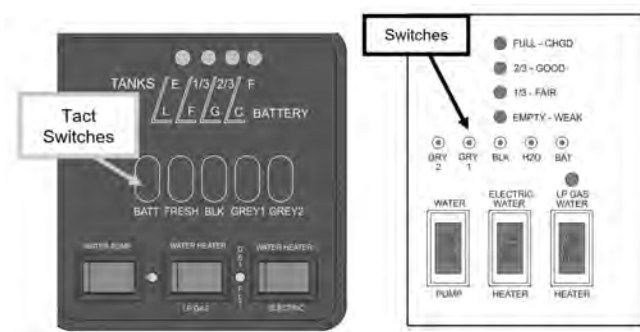

Monitor Panel

Command Center Panel

(Monitor panel appearance and components listed may vary)

SECTION 8: PLUMBING SYSTEM

Operation

Press only one “tact” switch at a time. As you push either the “FRESH”, “BLK” “GREY1” or “GREY2” switch, one or more LED lights will illuminate (from left to right) indicating the content level for that tank. When pushing the “BATT” switch, the LED lights illuminate from left (lowest) to right (highest) to indicate the estimated auxiliary battery condition.



NOTE: When using shore power all 4 LEDs will light. If disconnected from shore power, 3 LEDs will light to indicate a full charge. (The 4th LED may blink)

The LEDs corresponding to the letters C,G,F,L on the panel indicate the following:

- C** = Charge at 12.7 volts
- G** = Good at 12.1 volts
- F** = Fair at 11.6 volts
- L** = Low at 6.0 volts.

Water pump switch (if so equipped)

The red water pump switch is located on the monitor panel, the utility center or both (depending on your model). When the water pump switch is ON, the water pump will run until it reaches 45 lbs. of pressure. It will recycle when pressure drops. The switch will light up when it is turned ON. Turn the switch OFF when the water pump is not being used.

Water heater switches (if so equipped)

These red switches are located on the monitor panel. The “LP GAS” water heater switch (12V) enables propane operation of the water heater. The “ELECTRIC” water heater switch (120V) enables electric operation of the water heater. Normally both switches should be turned on to provide the fastest hot water recovery time. The water heater can be operated in electric only or gas only modes by pressing each switch independently. The switches will light up when turned ON. If the RV contains a tankless water heater, these switches will not be present on the monitor panel.

DSI FLT - Direct Spark Ignition Fault (if so equipped): This light located between the water heater switches will indicate a problem with the LP portion of the water heater. When the LP GAS switch is turned on, the light will blink quickly 3 times and the water heater will ignite. The light will then remain off. If the light comes on and stays on, it indicates the gas side of the water heater has not fired and there is a problem with the igniter.

FRESH WATER SYSTEM

All water contains contaminant and mineral particles that can cause fresh water system odors. Untreated well water is a major source of water system odors. The fresh water (or potable water) system needs periodic sanitization and winterization to take care of all the components within the plumbing system and help discourage the growth of bacteria and other organisms that can contaminate the water supply.

 WARNING

DO NOT drink water deemed microbiologically unsafe or of unknown quality.

 WARNING

Never travel with full fresh, black or grey water holding tanks.

FRESH WATER HOLDING TANK

There may be several ways to fill the fresh water tank depending on the model. For details of each method, refer to the *Fresh Water Connections* or the *Utility Center (if so equipped)* sections. There are plastic overflow tubes plumbed into the fresh water holding tank which allow water to flow out of the water tank (see City Water Fill). Occasionally, you may see water coming from the overflow tubes when the fresh water holding tank is filled. This is normal and can be a result of the recreation vehicle being parked on an incline, or the motion caused by starting or stopping during travel.

 CAUTION

Do not cap, block or modify the fresh water tank overflow tubes in any way. Enough water pressure can build up during the filling process to damage the plumbing system if the overflow tubes are obstructed.

 CAUTION

Be careful not to overfill the fresh water holding tank. It can pressurize the tank, causing leakage and water damage and void the warranty. DO NOT leave the tank unattended while filling.

12-VOLT WATER PUMP & SWITCH

When you want to use water in your recreation vehicle and it is not hooked up to city water, you will need sufficient 12-volt DC power to run the water pump.

Once activated, the water pump (also known as the demand pump) will self-prime, and provide water. The pump is designed for **intermittent use only**. Using the pump continuously or with high pressure will shorten the life of the pump and is not covered in your warranty. The water pump is engineered with a check valve to prevent water from back flowing into the fresh water supply tank.

Periodically check the in-line water pump strainer for accumulated debris. To clean, shut off the water pump, unscrew the clear cap, remove the re-useable metal strainer and clear any debris, then reinstall.

For additional information on the care and operation of the pump, read the safety and operating information in the pump manufacturer's owner's manual.

SECTION 8: PLUMBING SYSTEM

Water Pump Switch (if so equipped):

Most water pump switches illuminate when the water pump is activated. In most models, the (red) pump switch is located on the monitor panel or the utility center. When the water pump switch is ON the pump runs until 45 lbs. of pressure has been achieved. The red light will stay on. The water pump automatically recycles when pressure drops. Some cycling may occur depending on the volume of water being released. Turn the water pump switch OFF when it is not in use.

NOTE: If there are multiple pump switches; the pump must be turned off from the same switch used to turn it on. (e.g. if the pump is turned on at the utility center, it cannot be turned off with the switch inside the RV at the command center)

NOTE: Depending on the model, the water pump switch will be a black rocker switch located near the sink cabinet

The water pump switch should be in the OFF position when the RV is left unattended for any amount of time. If something would happen to the water system, this may help limit water damage to a smaller area.



Water pump

WATER PRESSURE REGULATOR (CUSTOMER SUPPLIED)

Excessive pressure from the water supply source may be encountered in some parks, especially in mountain regions when using the fresh water inlet or black tank flush. Water pressure regulators are available to protect your recreation vehicles plumbing system against such high pressure.

⚠ CAUTION

A water pressure regulator is recommended to prevent damage to the plumbing system or components. To prevent damage when using the city water connection, a 45 lb. (315 KPa) rated water pressure regulator is recommended.

FRESH WATER CONNECTIONS

Your recreation vehicle may be equipped with one or both of the following fresh water connections: city water and gravity fill. The city water fill has a threaded connector with a city water connection label next to it. Do not remove this label.

Using City Water Fill (If So Equipped)



NOTE: If needed, sanitize the water system prior to travel.

1. Remove the connection cap and attach a non-toxic drinking water hose to the threaded inlet.

The other end of this hose should be connected to a pressurized fresh water source (such as a faucet or spigot).

You should use a non-toxic drinking water hose dedicated only to supplying fresh water to the vehicle. To reduce the chance of contamination, prevent the non-toxic drinking water hose from coming into contact with the ground.



City Water Fill with City water connection label

2. Turn ON the water at the water source. Enter the vehicle and open the cold water



NOTE: The City Water Fill inlet when connected to a pressurized fresh water source sends water through the water lines and fixtures without the use of the pump. The fresh water tank cannot be filled using the city water fill (the gravity fill is used to fill the fresh water tank).

supply faucets to bleed air from the water lines. When the water lines are nearly full, you may experience some “air pockets.” Allow these to escape before closing the cold water supply faucets.

3. The water heater (if so equipped) will fill first, followed by the supply lines and faucets. Water heater bypass valves (if so equipped) A and B must be open to allow water into the water heater, valve C should be closed. Refer to the *Water Heater Bypass* section

SECTION 8: PLUMBING SYSTEM

for an explanation on configuring the bypass valves. Bypass valves are normally located near the water heater.

The fresh water connection should be unscrewed (i.e., the non-toxic drinking water hose disconnected) when the recreation vehicle is left unattended for any amount of time. If something would happen to the water system, this may help limit water damage to a smaller area.

To disconnect the City Water Fill

1. Shut OFF the water at the pressurized water source.
2. Disconnect the non-toxic drinking water hose and reinstall the connection cap. The connection cap should always be installed if the water fill is not in use.

Using the Gravity Fill (If So Equipped)

You can fill the fresh water tank from a container of fresh water and the gravity water fill inlet if you do not have access to City Water. Allow extra time to fill the fresh water system if you are using this method.

The gravity fill will have a potable water label next to it. Do not remove this label.

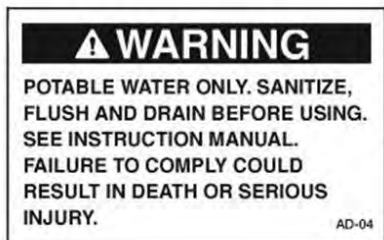

Potable Water Label



Gravity Water Fill

Using the Gravity Water Fill



NOTE: If needed, sanitize the water system prior to travel.

Low point & fresh water tank drains should be closed.

1. Remove the connection cap and insert a non-toxic drinking water hose (or a funnel) into the gravity fill inlet. The other end of the hose goes into a container of fresh potable water.
2. Pour the fresh water into the gravity fill until the tank is full.
3. Open both the hot and cold water faucets, along with outside shower faucets (if so equipped) when filling the fresh water tank to allow air pockets to be forced out of the system.

- When the fresh water tank on the RV is full, remove the non-toxic drinking hose and container from the gravity water fill. Replace the connection cap. This cap should always be installed if the water fill is not in use.

WATER HEATER

The water heater is designed to heat water quickly and efficiently. The water heater manufacturer has preset the sensing limit to maintain the water temperature when the water heater is activated.

WARNING

Hydrogen gas may result if you have not used the water heater for two weeks or more. **HYDROGEN GAS IS EXTREMELY FLAMMABLE.** To reduce the risk of injury under these conditions, open the hot water faucet for several minutes at the kitchen sink before you use any electrical appliance connected to the hot water system. If hydrogen is present, you may hear what sounds like air escaping through the pipe as the water begins to flow. Hydrogen gas may be present even after water has been drained from the water heater tank. Open the faucet at the sink and allow the system to vent for five to ten minutes. Do not smoke or have any open flame near the open faucet while venting. On DSI water heater models, make sure the switch is OFF.

WARNING

Do not replace any component part with an accessory part that is not authorized by the water heater manufacturer, such as an “add-on” electric heating element. Such items are not approved to be installed and could create an unsafe condition and will void all warranties.

Operating instructions:

WARNING

If you smell propane gas then STOP! and follow the procedures listed in the Fuel Systems section of this manual before attempting to operate the water heater.

Read the safety and operating information provided in the manufacturer’s manual before attempting to activate the water heater.

Make sure the water heater is filled with water before use; even momentary operation of the water heater without water in it may result in damage to the tank heating element and/or controls. **Double check the bypass valves**, make sure they are set properly.

Always open both the hot and cold water faucets when filling the fresh water tank to allow air pockets to be forced out of the water heater

Water heater switch (if so equipped)

The “propane GAS” water heater switch enables propane operation of the water heater. The

SECTION 8: PLUMBING SYSTEM

“ELECTRIC” water heater switch enables electric operation of the water heater. Switches are typically located on the Monitor Panel. For detailed information on their operation refer to the *Monitor Panel* section.

Water heater-pilot light (if so equipped)

This water heater is gas only with a pilot ignition. The water heater controls are typically located in an outside compartment, and is ignited manually from the outside of the vehicle. Hot water will be available in approximately 30 minutes.



Water Heater Pilot ignition

Refer to the water heater manufacturer’s manual for detailed lighting instructions.

Odor from the hot water system

Many water supplies contain sufficient amounts of sulfur to produce an odor, often called “sulfur water.” Sulfur water can be caused by a chemical action or by bacteria. Generally, sulfur water is not harmful, only unpleasant to smell. Refer to the water heater manufacturer’s owner’s manual for details on eliminating the odor from sulfur water. Odor from sulfur water is not a service problem.

⚠ WARNING

Do not replace anode rod or any other component with an accessory part that is not authorized by the water heater manufacturer, such as an “add-on electric heating element. Such items are not approved to be installed and could create an unsafe condition and will void all warranties

Anode rod protection

The tank in the water heater is protected by a magnesium or aluminum anode to prolong the life of the tank by absorbing the corrosive action of hot water. Under normal use, the anode rod will deteriorate and because of this, the water heater manufacturer recommends the anode rod be replaced yearly. Water with high levels of iron and/or sulfate will increase the rate of deterioration; therefore, more frequent replacements may be required.

If an anode rod is mostly eaten away, replace it with a new one. The water heater manufacturer recommends replacement of the anode rod when consumption or weight loss is greater than 75 percent.

Anode rod replacement chart

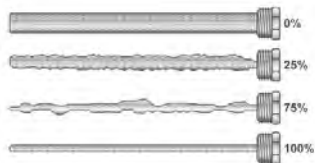

Operating the water heater without the proper anode rod protection will decrease tank life and will void the tank manufacturer's warranty on the tank. To extend the anode life, drain the water from the water heater tank whenever the RV is not being used. Avoid any extended time of non-use with water in the tank.

To prevent a water leak when replacing the anode rod, a pipe thread sealant approved for potable water (such as Teflon Tape) must be applied to the threads of the anode rod. Proper application of a thread sealant will not interfere with the anode's

High altitude deration

Operation of the water heater at high altitudes may require derating. If the water heater is not properly derated, lack of sufficient oxygen for combustion may produce improper burner operation. Pilot outage caused by burner lift-off or sooting from a yellow burner may occur, indicating the possibility of carbon monoxide.

You may also notice a lack of efficiency in heating the water because of incomplete combustion of the burner at these higher altitudes.

Consult with the local propane company, your dealer or the water heater manufacturer for proper derating of the water heater. Change out of the orifice (derating) should be done by the dealer or a qualified service agency.



NOTE: It is important that once the RV has returned to lower elevation (below 4500 feet) any high altitude deration or other adjustments be reversed for proper operation of the water heater.

Pressure & temperature relief valve

⚠ WARNING

Do not place a valve between the pressure and temperature (P&T) valve and the tank. Do not remove or plug the relief valve under any circumstances.

The temperature and pressure relief valve is designed to open if the temperature of the water within the heater reaches 120° F, or if the water pressure in the heater reaches 150 pounds. When this pressure is reached, the pressure relief valve will open and water will drip from the valve.

This "weeping" or dripping will continue until the pressure is reduced to below 150 pounds, and the valve closes. This condition is normal and does not indicate a defective relief valve.

One way to reduce the frequency of this occurrence is to maintain an air pocket at the top of the water heater tank. This air pocket will form in the tank by design; however, it will be reduced over time by the everyday use of your water heater. To replenish this air pocket:

1. Turn off the water heater.
2. Turn off the cold water supply line.
3. Open a faucet in the recreation vehicle.
4. Pull out the handle of the pressure relief (P&T) valve and allow water to flow from the valve until it stops.

SECTION 8: PLUMBING SYSTEM

5. Release the handle on the P&T valve - it should snap closed.

Close the faucet and turn on the cold water supply. As the tank fills, the air pocket will develop. Repeat this procedure as often as needed to reduce the frequency of the weeping P&T valve.

Maintenance

Do not allow the burner to burn with a yellow flame, or continue to operate the water heater with an improper burner flame.

Periodically, inspect the water heater vent for soot. Soot is a sign of incomplete combustion and must be corrected before operating the water heater. This is your visual warning that the water heater is operating in an unsafe manner.

If soot is present, immediately shut the unit down and contact your dealer or a qualified service agency.

Periodically inspect the vent for obstructions. Do not terminate the vent on your water heater inside of add-on rooms, screen porches or patios. Doing so will result in products of combustion being vented into the rooms or occupied areas.

Draining and winterization:

If the recreation vehicle is to be stored over the winter months, the water heater must be drained to prevent damage from freezing. Damage to the water heater caused by freezing is not warrantable. It is recommended the water heater be drained and bypassed during the winterization process, **particularly if introducing RV antifreeze into the plumbing system.**



NOTE: The water heater should never be drained when HOT or UNDER PRESSURE.

To drain the water heater:

1. Turn off electrical power to the water heater either at the switch from the electrical element or at the breaker.
2. Shut off the propane supply to the water heater.
3. Turn off the pressure pump on the water system.
4. Open both hot and cold water faucets.
5. Remove the anode rod from the tank.

For detailed information see the *Winterizing The Plumbing System* and *Water Heater Bypass* sections of this manual.

WATER HEATER BYPASS – 3 VALVES (IF SO EQUIPPED)

Most models have a factory installed water heater bypass that enables you to avoid filling the water heater with RV antifreeze. The 3-Valve Bypass is typically located in close proximity to the water heater.

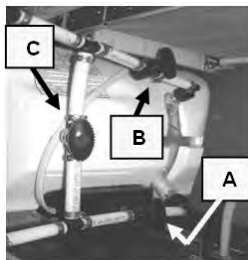

Factory installed
3-valve water heater bypass

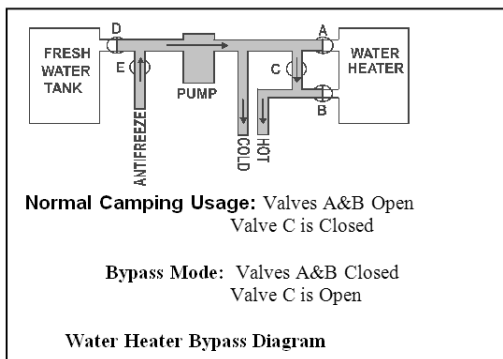

NOTE: In the 3-valve bypass diagram, valve D is the fresh water tank shutoff. Valve E is used to introduce RV antifreeze into the lines when winterizing the system and has a clear hose attached to it. See Winterizing the Plumbing System. Valves D & E are typically located near the water pump, which may be under a dinette bench, kitchen island, or bed.

Water heater switches (if so equipped):

The water heater switches are typically located on the monitor panel. Refer to the *Monitor Panel* section for function details.

OUTSIDE SHOWER (IF SO EQUIPPED)

A handheld shower assembly with both hot and cold water may be included for use outside of your recreation vehicle.

1. Be sure the water heater is ON and had sufficient time to heat the water.
2. Open the outside shower compartment door.
3. If dry camping, be sure the 12-volt water pump is ON.
4. Remove the handheld shower from its holder.
5. Turn ON the hot and cold faucet knobs, and adjust the water temperature as desired.
6. To activate the handheld shower turn ON the sprayer head attachment (some models).

To turn off the water, ***always*** close the hot/cold control (faucet) knobs. The lever on the shower head will not completely stop the flow of water; this is intentional to allow for draining. After the water has been allowed to drain from the shower head, return it to the outside shower compartment. Any remaining water in the shower hose will drip or run out; this is not a leak but performs as intended. If you are dry camping, turn the water pump OFF.

Turning off the water with the shower head lever can also create a condition where the hot and cold water will mix through the outside shower faucet, thereby reducing the temperature of the hot water. It can appear as though the hot water heater is not working properly.

SECTION 8: PLUMBING SYSTEM



NOTE: The shower head may be removed from the hose so that it will drain faster. If you remove the shower head, be sure to reassemble it prior to storage.



NOTE: When putting the shower assembly back into the storage compartment, make sure the hose is not pinched or the shower head is positioned in a way it can be damaged.

FAUCETS

The bathroom, kitchen and outside shower faucets operate much the same way as the faucets in your home. Make sure there is sufficient water available and the 12-volt water pump is turned ON before operating.



NOTE: There may be air in the water plumbing lines which needs to be bled out before a steady stream of water comes from the faucet.

⚠ WARNING

Water temperatures over 125°F (49°C) can cause severe burns instantly or death from scalds; therefore, be careful when using hot water. Always test the water temperature before showering or washing.

BATHROOM TUB / SHOWER

The shower faucet includes a vacuum breaker for the shower. There are two purposes for this breaker:

- To prevent siphoning water through the hose from another fixture.
- To prevent water from being retained in the hose.

The showerhead DOES NOT have a complete shut-off valve (the complete shut-off is at the faucet). The showerhead may drip slightly in the OFF position after use; this is normal and does not indicate a leak or defect.

There may be air in the plumbing lines that will need to be bled out before a steady stream of water comes from the faucet.

The bathing facilities in your recreation vehicle function similar to those in your home. Keep the water heater and holding tank capacities in mind when using the fresh water system. The used water will drain through the plumbing pipes into the grey water holding tank.

- Be sure the water heater is ON and had sufficient time to heat the water.
- If dry camping, be sure your 12-volt water pump is ON.

Unlike your home, the recreation vehicle does not contain a water pressure balance valve. If someone is using the shower, it is recommended that the fresh water system **NOT BE USED** until they are finished.

Maintenance

Refer the manufacturer's user guide or label instructions for detailed cleaning information. The tub/shower walls in your recreation vehicle are made of ABS plastic material. Use a mild detergent soap and warm water to clean. Do not use gritty or abrasive particle soaps or scouring compound to clean ABS plastic. Avoid using "Citrus" or biodegradable cleaners which contain "D-Limonene." They will damage plastic materials. Contact your dealer for repair or replacement.

WARNING

Water temperatures over 125°F (49°C) can cause severe burns instantly or death from scalds; therefore, be careful when using hot water. Always test the water temperature before showering or washing.

HARDWARE & SINK OR SHOWER FIXTURES

Use mild dish soap and water to clean these fixtures. Do not use harsh chemicals or sprays. A mild solution of vinegar and water works well to remove hard water spots and stains from the sink or shower fixtures.

DRAINING THE FRESH WATER SYSTEM

Permanent water tanks may be drained through a valve located near the tank. A recreation vehicle with a demand pressure pump system will have low-point drains attached to the water lines (normally located near the water tank).

These low-point drains will release water in the supply lines by opening the valves and all faucets. The water heater has its own drain plug. To drain the permanent fresh water holding tank and supply lines:

1. Turn the water heater power OFF (Turn off the Electric & LP GAS switches).
2. Open all faucets, including the outside shower faucet.
3. Open the "fresh tank drain" valve. All permanent fresh water tanks can be drained by one of two types of drain valves. A white plastic drain is attached to the exterior wall (open valve to drain) or a valve located inside the motor home adjacent to the water tank (this knob turns 45° to open or close).
4. Open the "low point drains" by turning, then pulling the handles up. As their name indicates, they will be at the lowest point of water lines. A label is placed on the outside of the RV to indicate where the drains are located. The drains will typically need to be opened from inside the motor home. Once the label is found on the exterior sidewall, go inside the motor home to find the corresponding location of the drains.



Exterior fresh water drain

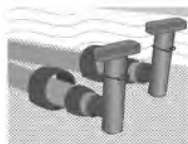

Low point drains

SECTION 8: PLUMBING SYSTEM

5. Drain the sink by removing the drain cap.
6. Turn ON the water pump and allow it to run as needed.
7. If the RV water heater has bypass valves: Set them to the BYPASS configuration. (refer to the *Water Heater Bypass* section). Disregard if there are no bypass valves.
8. Operate the toilet flush lever until water stops flowing.
9. Relieve the water pressure using the P&T valve BEFORE removing the water heater drain plug. If there is any water pressure present the water will spray out of the opening when the drain plug is removed.

When you are finished draining the fresh water system, reverse these steps and dump the grey and black water holding tanks at an appropriate facility or according to local public codes.

It is normal for some liquid to remain in the fresh water tank after drainage procedure.

SANITIZING THE PLUMBING SYSTEM

When to sanitize:

- When your recreation vehicle is new.
- At the beginning and end of each season.
- When the water system becomes contaminated or every three months of use.

How to sanitize

1. Turn water heater power OFF (storage style-both electric and LP gas switches; tankless water heater turn power switch OFF).
2. Set the bypass valves to BYPASS: valves A&B closed and valve C open (refer to *Water Heater Bypass Valves* section).
3. Level the RV and drain the fresh water system (see *Draining the Fresh Water System*).
4. Close the low point drain valves and the fresh water tank drain valve.
5. If the RV has a cartridge type water filter it must be removed and bypassed using the (supplied) bypass tube. Sanitizer should never be allowed into a water filter.
6. Prepare a chlorine solution using 1/4 cup of household bleach (sodium hypochlorite solution) to one gallon (3.785 liters) of water in a container. Prepare one gallon of solution for every 15 gallons of tank capacity. This will result in a residual chlorine concentration of 50 ppm in the water system.

If a 100-ppm concentration is required as discussed in step 12, use 1/2 cup of household bleach with one gallon of water to prepare the chlorine solution. One gallon of the solution should be used for each 15 gallons of tank capacity.



NOTE: Fresh water tank sizes vary by model; contact your dealer or customer service for your specific tank size.

7. Put the sanitizer solution in the fresh water tank: Insert one end of a hose (or funnel) in the gravity fill inlet, insert the other end into a container holding the chlorine solution. **Do not use your non-toxic drinking water hose.** Pour the chlorine solution into the gravity fill.

8. Remove the hose (or funnel) and container used to pour the chlorine solution, and continue filling the fresh water tank with clean (potable) water until tank is full: Pour fresh water into the gravity fill inlet until tank is completely full.

After the recommended amount of sanitizing solution is in the tank, the water tank is full, and water filter has been removed and bypassed, turn the pump ON which sends sanitizer into the water lines.

9. Open all hot water faucets one by one until water begins to flow continuously and a chlorine smell is noticeable. Include outside shower faucets (if so equipped).
10. Close the hot water faucets and repeat opening all cold water faucets one by one until you smell chlorine. Include outside shower faucets (if so equipped) and toilet.
11. Turn OFF the water pump.
12. Let the solution remain in the tank & lines for at least four hours when disinfecting with 50-PPM residual chlorine. If a shorter time period is desired, then a 100-PPM chlorine concentration should be permitted to sit in the system for at least one hour.



NOTE: To thoroughly sanitize the fresh water tank, the unit should be driven around for a period of time allowing the solution to splash the sides and top of the tank.

13. After the required period, drain the chlorine solution from the fresh water system (see *Draining the Fresh Water System*). Since the water heater was bypassed there should be no sanitizer in the (storage) tank water heater.

Rinse the system with fresh water:

1. Fill the fresh water tank full of clean (potable) water. Fill fresh water tank from an external container. Pour fresh water into the gravity fill inlet using a hose (or funnel).
2. Power to water heater should be OFF. (both switches: electric & LP gas) When the fresh water tank is full: Turn the pump ON to send water through the lines.
3. Run water through all faucets (hot & cold, including outside shower) until chlorine smell is gone. Turn faucets and outside shower off, turn pump OFF.
4. Then, drain the fresh water system again. (see *Draining the Fresh Water System*).
5. **Water heater bypass valves (if so equipped):** Close bypass valve C, open valves A&B on water heater, replace water heater drain plug.
6. Refill the fresh water tank with fresh water again and when water heater is full of water, turn the water heater power ON. Refer back to Step 14 above for instructions on refilling the fresh water tank.

SECTION 8: PLUMBING SYSTEM



NOTE: If a chlorine taste lingers in the water, flush the water system with a solution consisting of one-quart vinegar to five gallons of clean water. Re-flush as necessary. The vinegar solution may damage the water heater or the water filter, so both must be bypassed again before performing this operation.

Follow the steps outlined in *Draining the Fresh Water System* with one exception, do not drain the water heater. **Water heater bypass valves (if so equipped)**, close valves A&B and open valve C. Do not remove the water heater drain plug.

Remove the cartridge water filter (if equipped) and replace it with the bypass tube included with your RV.

After draining the system:

1. Water heater power should be OFF. (both switches: electric and LP gas) Water heater bypass valves (if applicable): A&B should be closed, valve C open.
2. Put the vinegar solution into the fresh water tank. Pour the vinegar solution into the gravity fill using a hose (or funnel).
3. Continue filling the fresh water tank with of clean (potable) water. Pour fresh water into the gravity fill inlet using a hose (or funnel).
4. Run water through all faucets (hot and cold, including outside shower) until chlorine smell is gone. Turn the pump ON to send water through the lines.
5. Close all faucets including outside shower. Turn pump OFF.
6. Drain the system again, but don't drain the water heater. **Water heater bypass valves (if so equipped)**: leave valves A&B closed and valve C open. Do not remove water heater drain plug.
7. Close low point drains and fresh water tank drain.
8. Refill the fresh water tank with clean potable water. Use the gravity fill, (refer to Step 3 for specific instructions).
9. Open faucets and check that the chlorine taste is gone.
10. Drain the system one more time (See *Draining the Fresh Water System*)
11. Remove full system canister, insert the filter, and reattach canister to the mount. For **water heater bypass valves (if so equipped)**: Open valves A&B, close valve C.
12. Refill the fresh water system with clean water. When the water heater is full of water, turn the water heater power ON.

WINTERIZING THE PLUMBING SYSTEM

Preparing your RV for colder weather or storage is very important for most states and Canada. Failure to prepare your RV may cause water supply lines and the water heater to freeze.

If you chose to perform the winterization process yourself, please read and understand the following information before starting. Contact customer service or your dealer for questions about this procedure.



NOTE: The following winterization process represents the typical application. Your process may vary slightly due to varied plumbing configurations between models.



NOTE: If your recreation vehicle is equipped with a Frigidaire or Samsung RESIDENTIAL REFRIGERATOR, the air method should be used for the appliances. RV antifreeze should not be used in the refrigerator. See Winterizing Appliances or contact your dealer for assistance.

There are two methods to winterize your RV:

Compressed Air Method: This method uses compressed air to blow out any remaining water in the system after initially draining water using drain valves. Tools required would be an air compressor and a blowout plug.

Winterizing with antifreeze:

Requires non-toxic RV antifreeze in the water lines and does not require any special tools.

Use **ONLY RV ANTIFREEZE** in your fresh water system for freeze protection. No other product or commodity should be used.



NOTE: The water heater must be drained to prevent damage from freezing. The water heater should be drained and bypassed during the winterization process particularly if introducing RV antifreeze into the plumbing system. Antifreeze should be kept out of the water heater. **DO NOT DRAIN THE WATER HEATER WHILE IT IS HOT OR UNDER PRESSURE!**

CAUTION

If the recreation vehicle is going to be stored in a non-temperature controlled environment with a risk of temperatures reaching 32°F (0°C) or lower, the air pressure method is not adequate, winterizing with RV antifreeze must be used in the plumbing system. Repairs due to freezing are not covered under the terms of the Towable Limited Warranty

The preferred method of winterization is using RV antifreeze in the plumbing system. Use **RV ANTIFREEZE ONLY** in your fresh water system for freeze protection. No other product or commodity should be used.

SECTION 8: PLUMBING SYSTEM

The RV should be winterized at the end of the camping season or when it will be exposed to temperatures at or below 32°F (0°C). Repairs due to freezing are not covered under the terms of the **Towable Limited Warranty**.

Air Pressure Method

This method utilizes a blowout plug, an air compressor and an air hose to remove excess water out of the water lines. A second person will make this job a little easier.

WARNING: RECOMMENDED AIR PRESSURE IS 30 PSI MAXIMUM.
Exceeding this air pressure may rupture water line couplings / seals and void your warranty.

WARNING

Never apply air pressure to the water system with any of the valves/ drains in the closed position. Air pressure applied to a closed valve, faucet or low point drain could potentially damage the seals and cause water leaks. If you have questions, consult with your RV dealer. Using RV antifreeze is the preferred method of winterization.

1. Turn off the water heater gas valve typically located outside the RV. Water heater power should be OFF Turn off both ELECTRIC and GAS switches at the command center panel)
2. Level the RV and drain the fresh water plumbing system See *Draining the Fresh Water System*.
3. Water heater bypass should be OFF which will allow air to flow through the water heater. If the drain plug is still in place, it should be removed (as shown). Refer to the *Water Heater Bypass* section.

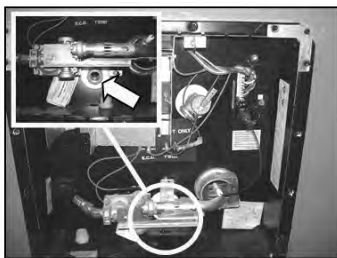

Water heater drain plug location

4. RV water filter should be removed for winterizing. Refer to *Water Purification System* section. Your RV may have a cartridge type water filter. Remove the cartridge filter (if so equipped), and replace it with a bypass tube supplied with your RV. Antifreeze should be kept out of the water filter.

 **NOTE:** Filters should be replaced at the beginning of the camping season or if they have come into contact with contaminated water or antifreeze.

5. Run the pump until it is dry (approximately 15 to 20 seconds). Operating the pump longer than that with no water in it can damage the pump.
6. Open all faucets in the RV. If there is an outside shower, attach the shower hose to the shower, and open the shower faucets.
7. Attach a blowout plug to the city water inlet on the outside of the RV.



Blowout plug

Refer to *Fresh Water Connections*.

8. Attach the air hose to the blowout plug. Set compressor to **30 PSI**.
9. Fresh water tank drain should be open.



NOTE: If your RV is equipped with a water tank shutoff valve (located near the water pump) this valve should be opened to allow air to blow into the water tank (refer to Water Heater Bypass).

10. Blow air into the water lines through the blowout plug and the City Water Inlet to evacuate all water from the lines. Air should only be blown into the water tank for 30 to 60 seconds, to avoid pressurizing the tank then turn the water tank shutoff valve OFF. Continue blowing out the water lines which can take 5 to 10 minutes.
11. Pour one cup of RV antifreeze in all the drain P-traps (sinks & bathtub).
12. After RV water lines have been blown out, remove the air hose and the blowout plug from the City Water Inlet.



Exterior fresh water drain

Winterize the Black Tank Flush (If So Equipped)

1. Connect the blowout plug to the black tank flush inlet on the outside of the RV.
2. Connect the air hose to the blowout plug. Set the compressor to **30 PSI maximum**.
3. **Make sure the black tank has been emptied.** Open the black tank drain valve.
4. Blow air into the flush inlet for 30 to 60 seconds.
5. Disconnect the compressor and blowout plug.
6. Close the black tank drain.

Winterizing with Antifreeze Method

⚠ WARNING

Automotive antifreeze (ethylene glycol) and windshield washer antifreeze (methanol) are poisonous. Never use these products in your fresh water system. These products are harmful and may be fatal if swallowed.

It may be easier to winterize the RV with another person to assist you.



NOTE: Antifreeze should never enter the water heater, RV water filter, refrigerator, refrigerator water filter, or fresh water tank.

1. Turn water heater power OFF. Turn water heater gas valve (if so equipped) OFF (outside of the RV).
2. Water heater bypass should be ON. Close valves A and B on the water heater, valve

SECTION 8: PLUMBING SYSTEM

C should be open. Refer to *Water Heater Bypass Diagram*. Water is prevented from entering the water heater.

3. Level the RV and drain the fresh water plumbing system. See *Draining the Fresh Water System*.
4. Water heater should be empty after performing Step 2. Water heater bypass should still be ON (if so equipped). See *Water Heater Bypass Diagram*.
5. Cartridge water filter (if so equipped) should be removed and replaced with the bypass tube included with your RV.
6. Make sure the “fresh water tank drain” and “low point drains” are closed.
7. Close the fresh water tank shutoff valve “D” (if so equipped). Valve should be located in the vicinity of the water pump. See *Water Heater Bypass Diagram*.
8. Open siphon valve “E” on the water pump with the clear hose attached and insert the opposite end of the clear hose into a container of RV antifreeze solution. Valve should be located in the vicinity of the water pump. See *Water Heater Bypass* section.
9. Turn the water pump ON. Antifreeze will be drawn into the water lines.



NOTE: In order to create a suction all low point drains must be closed.

10. Open the hot water faucets, including outside shower (if so equipped) until RV antifreeze begins to flow continuously.
11. Close the hot water line faucets and outside shower and repeat with the cold water line faucets. Hold open the lever on the toilet until antifreeze runs into the bowl.

When you are done adding RV antifreeze:

1. Turn the water pump OFF. Turn siphon valve “E” OFF. Remove the clear hose from the container of RV antifreeze. Leave the water tank shutoff valve “D” closed to keep antifreeze out of the fresh water tank. See *Water Heater Bypass Diagram*.
2. Pour 1 cup of RV antifreeze into the sink drain P-trap.
3. To prevent staining, wipe the RV antifreeze out of the sinks, shower (or tub) and toilet using a soft, dry cloth.



NOTE: In the spring when flushing antifreeze out of the water lines make sure to turn valve “D” (the fresh water tank shutoff) back ON. After flushing out water lines the water filter (is so equipped) should be re-installed.

BLACK/GREY WATER SYSTEM

Water from the sinks and shower flows into the gray water (or waste water) holding tank. Water from the toilet will flow into the sewage (or black water) holding tank.

⚠ WARNING

Never travel with full black or grey water holding tanks. This not only wastes your fuel but depending on the location of the tank(s), it can affect your tow vehicle handling characteristics.

The weight of the holding tank contents is not calculated into the RV cargo carrying capacity (this extra weight would reduce your available cargo capacity). Traveling with full holding tank(s) could possibly cause you to exceed the individual tire ratings and/or the RV GAWR or RV GVWR. Potential damage to suspension components, such as springs, tires and axles, could result.

If your RV holding tank(s) are located behind the axles, the weight of the full tank(s) will reduce the hitch weight. Trailer sway and other handling difficulties can be the result of the hitch weight being too light.

Dump the gray and black water holding tanks before traveling to avoid carrying unnecessary weight. If you are dry camping and cannot immediately empty your holding tanks, reduce your vehicle speed until you reach a dumping station.

Before using the RV or after dumping the grey and black water holding tanks, always add the proper amount of deodorant to the black water tank to prevent malodors and help break down holding tank contents (unless winterizing). Follow the deodorant bottle or package instructions. Driving to a disposal site will normally loosen any accumulated waste debris or solids from the sides of the holding tanks.

⚠ WARNING

Do not add automotive antifreeze or caustic chemicals such as laundry detergents into the holding tanks. Although these products may have a deodorizing effect, they may damage the plastic and rubber parts of the plumbing system or the components.

Drain pipes With P-Trap (If So Equipped):

The drain pipes may be equipped with a “P-trap” installed to help prevent odors from escaping into the RV. During travel, water from the P-traps may spill and permit odors into the RV. By adding water and using a RV approved deodorizing agent you will dissolve the contents faster and will keep the drain lines and tanks clean and free flowing. These chemicals are available at an RV supply store or your dealer.

Drain pipes With Dry Sealing Valve (If So Equipped):

Your RV may be equipped with a dry sealing valve that prevents the escape of odors from your waste system and eliminates the need for P-traps. Should the RV drain piping system become clogged and a mechanical cleanout tool is used to open the drain pipe, it is important that the dry valve be removed before passing the cleanout tool through the piping. Passing a

SECTION 8: PLUMBING SYSTEM

mechanical cleanout tool through the waterless valve may cause damage to the internal seal that may potentially allow sewer gases to escape into the RV interior. A label has been placed near the location of the waste valve that reads as follows:

REMOVE WATERLESS TRAP BEFORE
USING MECHANICAL DRAIN – CLEANING DEVICES

Vents:

Another important part of this system is the vent pipes and vents that release air from the grey and black water holding tanks. On most models the exterior vent cap is attached to the roof and must be kept clear of obstructions to perform as intended. On some models, the vent pipe may be part of the drainage system referred to as a “wet vent” (water flows downward as air flows upward in the same pipe).

Some models are equipped with a side vent system. On these models the following label will be next to the termination valve. This label should not be removed from your recreation vehicle.

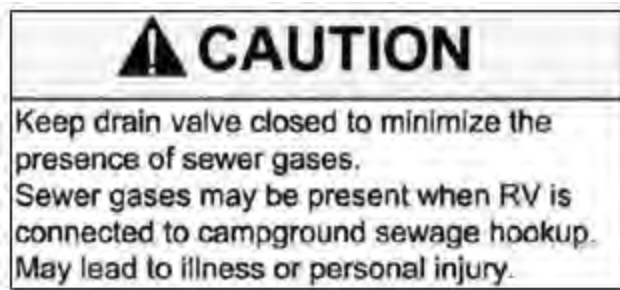

Sewer Hose Storage:

Depending on your RV model, the sewer drain hose may be stored in an exterior compartment marked “Sewer Hose” or it may be located in the hollow square tube bumper. The bumper has removable plastic end caps, and the hose slides inside the hollow bumper.

BLACK/GREY WATER HOLDING TANKS

When connected to the sewer drain line at a campground, keep the “black tank drain” valve closed until the holding tank is at least $\frac{3}{4}$ full. This should provide sufficient water to assist in complete draining of the black water holding tank. Repeat as needed. Never leave the black tank drain in the open position continuously when connected to the campground sewer system.

Traveling with the tanks full can affect your fuel consumption, and depending on the location of the tanks, can affect your vehicle handling characteristics. If you are dry camping and cannot immediately empty your holding tanks, reduce your vehicle speed until you reach a dumping station.

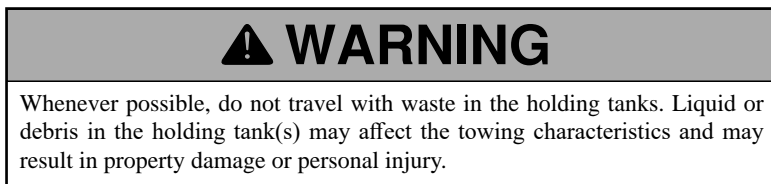

BLACK & GREY TANK DRAINS

There are labels on the exterior of the recreation vehicle indicating the location of the grey tank drain and black tank drain (also called dump valves). Always drain the black water holding tank first so the following grey tank waste water can help rinse any solids or debris from the dump outlet and sewer hose.

1. To make drainage easier, level the RV.
2. Remove the sewer hose housing dust cap, and attach the sewer hose (customer supplied).
3. Place the end of the sewer hose into the approved dump station.
4. Open the black tank dump valve (depending on your model the valve may be located under the RV, or on the utility center). Close the dump valve when the black water holding tank is empty.
5. Open the grey tank dump valve (depending on your model the valve will be located under the RV or on the utility center). Close the dump valve when the grey holding tank is emptied.
6. Remove, clean and store the sewer hose.
7. Close the sewer hose housing dust cap.



Black/Grey tank drain & valves

You can locate many dump stations throughout the United States and Canada in Woodall's, Rand McNally Camp Guide, Good Sam Camp Guide, KOA Campgrounds Camp Guide and various other publications. Some fuel stations also have dump stations.

Please contact your RV dealer for assistance in the purchase and installation of a sewer hose or sewer hose extension (if needed).

Sewage (black) tank preparation:

<p>⚠ WARNING</p>
<p>It is important to add enough water to prevent solid waste buildup. Follow the directions listed below and in the manufacturer's operator manual.</p>

1. Release one to two quarts (1 or 2 liters) of water into the toilet bowl.
2. Follow the directions on your (RV approved) toilet chemical bottle (customer supplied), by placing the recommended quantity of holding tank chemical into the toilet bowl.
3. Flush the toilet and allow at least two gallons (8 liters) of water to flow into the holding tank.

Waste (grey) holding tank preparation:

No special preparation is required, however, placing a small quantity of chemicals into this tank, such as baking soda or an approved RV chemical, will reduce odors from food particles in the system.

Cleaning & Maintenance:

The toilet should be cleaned regularly for maximum sanitation and operational efficiency. Use only RV approved chemicals. Do not use chlorine (undiluted) or caustic chemicals,

SECTION 8: PLUMBING SYSTEM

such as laundry bleach or drain opening types, in the toilet system. These products damage the seals in toilets and dump valves.

BLACK TANK FLUSH

The sewer tank flusher inlet (also known as the no fuss flush) will have an identifying label next to it. This inlet is provided to assist in flushing out the black water tank. **The drain valve for the black water tank must be OPEN to use this feature.** When the hose is connected, and when the water source is turned on, it sprays water into the black water tank. This allows you to rinse the black water holding tank by removing debris and preventing accumulation. There is a check valve incorporated in the plumbing lines to prevent back flow. **Using the Tank Flush Inlet:**



Tank Flush Inlet

1. Connect the flexible sewer hose to the 4 inch dump outlet.
2. Open the black water dump valve and leave it open. Allow the tank to drain.
3. Attach a water hose to the tank flush inlet. Do not use your fresh water hose for this.
4. Attach the other end of the water hose to a pressurized water source (40 PSI minimum).
5. Turn ON the water source flushing the tank until water appears to run clear from the sewer hose.
6. Turn water source OFF. Disconnect water hose from the source and from the tank flush inlet.
7. Close the black water dump valve.



CAUTION

The black tank drain valve must be OPEN any time there is a hose (water supply) connected to the black tank flush.



CAUTION

Do not leave any hose (water supply) connected to the black tank flush when it is not in use.



WARNING

Do not use the same hose to fill your fresh (potable) water tank that is used for the black tank flush.

TOILET

The toilet is efficient and easy to operate. Generally, more water is required only when flushing solids. Prior to using the sanitation system, it is strongly recommended to flush the toilet several times to release sufficient water into the holding tank. If there is not a sufficient amount of water used during flushing, the waste materials may not evacuate properly from the drain line to the tank. Clogged tanks and pipes could eventually occur.

The toilet system will perform better when water is run for ten to fifteen seconds after

flushing to ensure that the waste will proceed to the bottom of the tank.

Unlike a toilet in a home, which may use up to seven gallons of water per flush, the average recreation vehicle system uses one to three quarts (1 - 3 liters). For added convenience and better sanitation system performance, it is advisable to always have four to six inches (10 - 15 cm) of water in the toilet.

WARNING

It is important to prevent solid waste buildup. Follow the toilet manufacturer's recommended instructions each time after emptying the black water holding tank.

CAUTION

To prevent help toilet blockage, always use RV grade single-ply toilet paper. Do not flush paper towels, diapers, sanitary napkins or other foreign objects down the toilet.

It is important to add enough water to prevent solid waste buildup. The following guidelines will help to prevent solid waste buildup.

Sewage (black) tank preparation

1. Release one to two quarts (1 or 2 liters) of water into the toilet bowl.
2. Follow the directions on your (approved RV) toilet chemical bottle (customer supplied), by placing the recommended quantity of holding tank chemical into the toilet bowl.
3. Flush the toilet and allow at least two gallons (8 liters) of water to flow into the holding tank.

Waste (grey) holding tank preparation

No special preparation is required; however, placing a small quantity of chemicals into this tank (such as baking soda or an approved RV chemical) will reduce odors from food particles in the system.

Cleaning & Maintenance

The toilet should be cleaned regularly for maximum sanitation and operational efficiency.

CAUTION

Do not use chlorine (undiluted) or caustic chemicals, such as laundry bleach or drain opening types, in the toilet system. These products damage the seals in toilets and dump valves.

For detailed information refer to the manufacturer's operator manual.

SECTION 8: PLUMBING SYSTEM

Notes:

AIR CONDITIONER

Roof Mount (If So Equipped)

The roof mounted air conditioning system is controlled by a thermostat. Cooled air enters the RV through the adjustable “chill grill.” Make sure you have sufficient power available before operating the air conditioner. Do not operate the air conditioner without the return air filter. Operating the system without the filter allows the lint and dirt that is normally stopped by the filter to accumulate on the cooling coil of the air conditioner. This also will lead to a loss of air volume, possible equipment damage and an expensive cleaning process.

A special foam gasket is placed between the roof material and the subframe of the air conditioner to guard against water leakage. The air conditioner is subjected to wind pressures along with motor vibration during normal operation. Inspect the mounting bolts for tightness to ensure there is no leakage or looseness at least annually. Re-tighten bolts when they are loose. **DO NOT** over tighten these bolts as it may damage this gasket. The air conditioner gasket is a wearable part that eventually will need to be replaced. To gain access to the bolts, remove the filtered panel cover on central air systems or the entire air box on non-central air conditioners. Consult the manufacturer’s operators manual or your RV dealer for more information.

For additional information refer to the manufacturer’s owner’s manual included in your warranty packet.

Wall Mount (If So Equipped)

The wall mounted air conditioning system is controlled by a thermostat. Cooled air enters the RV through the grill. Make sure you have sufficient power available before operating the air conditioner. Do not operate the air conditioner without the return air filter. Operating the system without the filter allows the lint and dirt that is normally stopped by the filter to accumulate on the cooling coil of the air conditioner. This will lead to a loss of air volume, along with possible machine failure. Keep the air inlet grill and cabinet clean by wiping with a cloth dampened with warm water and a mild detergent.

For additional information refer to the manufacturer’s owner’s manual included in your warranty packet.

POWER ROOF VENT (If So Equipped)

The 12-volt DC attic fan (or powered roof vent) allows fresh air to circulate through the recreation vehicle. Do not leave the attic fan open when the recreation vehicle is stored or unattended for long periods.

High winds, other unusual conditions or obstructions may prevent the dome from closing; the resulting leakage could cause non-warrantable damage.

To use your fan most effectively, close all vents and slightly open a window on a shaded side of your recreation vehicle. You are directing the air flow by opening a window. You will receive the greatest airflow comfort by positioning yourself between the window and the fan.



Attic Fan Control

For additional information refer to the manufacturer’s owner’s manual included in your warranty packet.

SECTION 9: HEATING & COOLING

Control pad (if so equipped)

The attic fan may be controlled by a control pad. The dome can be raised or lowered with the UP/DOWN buttons, and the speed of the fan is controlled by the ARROW buttons. It is also equipped with a rain sensor that will close the vent automatically when it rains. The rain sensor can be turned on/off by holding the DOWN button for 3 seconds.

DUCTING & RETURN AIR

All heat discharges, registers and return air grills must be free and clear of obstructions. This includes all closeable registers that are intended to reduce airflow, do not shut it off completely.

FURNACE

The furnace installed in your recreation vehicle is controlled by a 12-volt DC thermostat. Depending on your model, there may be up to two thermostats in your recreation vehicle to enabling you to control the temperature to your comfort level.

The furnace requires both 12-volt power and propane gas for full operation. Make sure you have sufficient power available before operating your furnace.

If you have any questions contact your dealer or Customer Service. A qualified RV technician should perform all furnace maintenance at least once a year (more often depending on furnace usage). Never attempt to repair the furnace yourself.

WARNING

The furnace should be inspected periodically (monthly during the heating season) for presence of soot on the vent. Soot is formed whenever combustion is incomplete. This is a visual warning that the furnace is operating in an unsafe manner. If soot is observed on the vent, immediately shut the furnace OFF and contact a qualified service agency. Operating the furnace under this condition could lead to serious property damage, personal injury or loss of life.

WARNING

To ensure your personal safety, do not obstruct or alter the furnace in any manner. Do not install screens over the vent for any reason. Screens will become restricted and cause unsafe furnace operation. For your safety, only the manufacturer's factory authorized parts should be used on your furnace.

MICROWAVE



NOTE: To prevent damage, remove the turntable from the microwave when traveling.



NOTE: Make sure you are connected to a 120-volt power source.

⚠ WARNING

Never use the microwave cavity for storage. The microwave cavity should always be empty when not in use.

Microwave Oven Use

For list of preset programs, see the Quick Reference Guide provided with your model.

General Cleaning

IMPORTANT: Before cleaning, make sure all controls are off and the microwave oven is cool. Always follow label instructions on cleaning products.

To avoid damage to the microwave oven caused by arcing due to soil buildup keep cavity, microwave inlet cover, cooking rack supports, and area where the door touches the frame clean.

Clean with mild soap, water and a soft cloth or sponge, or as indicated below.

- Grease filters: mild soap and water or dishwasher.
- Door and exterior: mild soap and water, or glass cleaner applied to paper towel.
- Control panel: sponge or soft cloth and water.
- Stainless steel (on some models): mild soap and water, then rinse with clean water and dry with soft cloth, or use stainless steel cleaner.
- Turntable: mild soap and water or dishwasher.
- Rack(s): mild soap, water and washcloth. Dishwasher cleaning is not recommended.

Convection Microwave (if so equipped)

For details on operation, cleaning and safety information, refer to the manufacturer's user guide included in the Warranty Packet, or visit the manufacturer's website.

The convection microwave bridges the gap between microwaving your food and conventional cooking. **Make sure there is sufficient 120-volt power available before operating the convection microwave** (refer to *Sec. 6 Electrical Systems, Calculating electrical load*).

COOKTOPS (IF SO EQUIPPED)

For detailed operating and safety information, refer to the manufacturer's user guide included in the Warranty Packet.

WARNING

During and after use, do not touch or let clothing or other flammable material come in contact with the top burners (or heating elements), burner grates or other areas near the top burners or oven until they have had sufficient time to cool. These areas can get hot enough to cause burns.

WARNING

If using glass, glass/ceramic, ceramic, earthenware or other glazed utensils (or cookware) verify it is safe for use on the top burners. Only certain types of utensils (or cookware) are suitable for surface or top burner use.

WARNING

Never leave cooking food unattended. Turn pan handles inward, but not over the tops of the other range burners. Ensure that pans used are large enough to contain the food and avoid boil-overs. Heavy splattering or spills left on the cooktop can ignite and cause burns.

CAUTION

Never use oven cleaners, chlorine bleach, ammonia or glass cleaners with ammonia. Always allow the cooktop to cool before cleaning.

Cleaning instructions

Refer to the manufacturer's user guide included in your Warranty Packet for detailed cleaning instructions.

General Cleaning

- Be sure appliance is off and all parts are cool *before* handling or cleaning. This is to avoid damage and possible burns.**
- Use care to avoid steam burns if a wet sponge or cloth is used to wipe spills on a hot surface.
- Some cleaners can produce noxious fumes if applied to a hot surface.
- To prevent staining or discoloration, clean appliance after each use.
- If a part is removed, be sure it is correctly replaced.
- If a spillover occurs while cooking, immediately clean the spill from the cooking area while it is hot to prevent a tough cleaning chore later. Using extreme care, wipe spill with a clean, dry towel.

Electric drop in cooktops (if so equipped)



NOTE: Make sure you are connected to a 120-volt power source.

⚠ CAUTION

Do not use aluminum foil on the electric range cooktop, as this material will damage the cooktop surface if it melts. **Do not use aluminum foil under any circumstances on the electric range cooktop.**

Gas drop in cooktops (if so equipped)

Drop in cooktops add compact high efficiency cooking performance to your recreation vehicle. Depending on your model, it may be equipped with either a 2 burner or 3 burner cooktop.

The 2 burner match-light cooktop has two 6500 BTU/H burners with control panel. The 3 burner piezo-igniter cooktop has one front 9000 BTU/H burner and two rear 5200 BTU/H burners. The 3 burner cooktop is also equipped with a control panel.

For detailed operating and cleaning information, refer to manufacturer's owner's manual.

KITCHEN RANGE & OVEN (IF SO EQUIPPED)

⚠ WARNING

If using glass, glass/ceramic, ceramic, earthenware or other glazed utensils (or cookware) verify it is safe for use on the top burners. Only certain types of utensils (or cookware) are suitable for surface or top burner use.

⚠ WARNING

If using glass, glass/ceramic, ceramic, earthenware or other glazed utensils (or cookware) verify it is safe for use on the top burners. Only certain types of utensils (or cookware) are suitable for surface or top burner use.

⚠ WARNING

Never leave cooking food unattended. Turn pan handles inward, but not over the tops of the other range burners. Ensure that pans used are large enough to contain the food and avoid boil-overs. Heavy splattering or spills left on the cooktop can ignite and cause burns.

To prevent damage, always use the manufacturer's recommended size flat bottom pan(s). Generally, the pan should be large enough to cover the burner, but not be more than one inch larger than the burner grate.

Do not use a broiler pan, griddle or any other large utensil that covers more than one burner at a time. This will create excessive heat that may cause melting, sooting or discoloration.

The use of undersized pans could expose a portion of the heating element to direct contact and may result in ignition of clothing. Proper relationship of pans to burner will improve efficiency.

SECTION 10: APPLIANCES

Refer to the manufacturer's user guide for detailed operation, cleaning and safety information.

Oven (if so equipped)

WARNING

Do not cover the oven vent openings while the oven is in operation. Restricting the flow of combustion air will create an asphyxiation hazard.

The propane gas oven must have 12-volt power to operate. If you have any questions contact your dealer or our customer service department. **Do not use the oven as a storage area.**

Refer to the manufacturer's user guide for detailed operation, cleaning and safety information.



NOTE: To help reduce potential condensation or unwanted cooking odors, turn on the overhead kitchen roof vent or the range hood vent (if so equipped).

GAS BBQ GRILL (If So Equipped)

WARNING

Be sure to read, understand and follow all information supplied with your recreation vehicle concerning the use of propane before operating the BBQ grill. The propane hose must be correctly connected before lighting the grill. Failure to follow instructions supplied by the grill manufacturer, or use of any components other than those originally supplied with the grill, could result in death or serious injury.

WARNING

The maximum weight limit for the bracket supporting your BBQ grill is 50 lbs. This limit includes the weight placed on the BBQ grill. Exceeding this weight limit could result in injury or property damage.

WARNING

The BBQ grill is for use outside of the recreation vehicle. **Never use this grill inside a compartment or inside of the recreation vehicle.** Before operating the BBQ grill, make sure that it is securely mounted on the support rail attached to the side of the recreation vehicle (if so equipped) or the bumper mounting bracket (if so equipped).

⚠ WARNING

Always open hood before turning on gas and lighting burner, failure to open the hood before lighting could cause an explosion causing property damage, injury, or even death.

⚠ DANGER

Always open hood before turning on gas and lighting burner, failure to open the hood before lighting could cause an explosion causing property damage, injury, or even death.

⚠ WARNING

The BBQ grill must be **COMPLETELY COOLED** before storing it. The grill should be cool to the touch before storing. Storing the BBQ grill before it is completely cool may result in serious injury or property damage.

Refer to the grill manufacturer’s user guide for detailed operating and safety information.

Depending on your model, your grill will be mounted with either a bumper mount system, or a rail mount on the side of your recreation vehicle.

Bumper mount (if so equipped)

- Insert the grill mounting bar (with the pins) into the bracket (mounting tube) on the rear bumper of the recreation vehicle.
- Insert the pin through the hole in the bracket and mounting bar. The pin must be installed to insure the mounting bar is secure during use.
- Tighten the T-handle on the bracket mounted to the bumper.
- Set the BBQ grill on the mounting bar by inserting the (2) pegs on the bar into the grill side mounting brackets. Make sure the mounting bar and the grill are securely in place before proceeding with the propane connection.



Bumper mounting bracket

Rail mount (if so equipped)

- Hang the grill bracket on the aluminum mounting strip located on the side of the recreation vehicle.
- Open the (2) folding arms on the bracket making sure they lock in position.

SECTION 10: APPLIANCES

- Slide the grill onto the (2) arms against the stops. Make sure the grill is fully on the arms.
- Insert the retaining pins into the arms.
- To remove the grill, remove the retaining pins and simply slide it off of the bracket arms. Wait until grill has cooled down before removing it.

-
-
-
-



Gas Grill & Mounting



Bracket on Support Rail

Gas BBQ Grill Prep (if so equipped)

Your recreation vehicle may be equipped with a propane “quick-coupler” connection and support bracket for easy installation of the BBQ grill.

Attaching the “quick coupler” connection

The “quick coupler” is directly connected to the RV propane system. The “quick-coupler” connection is equipped with a positive shut-off valve.

Place the “quick coupler handle in the OFF position and push back the sleeve. The valve handle must be OFF to make the connection.

1. Insert the plug and release the sleeve.
2. Push the plug until the sleeve snaps forward, locking the plug into the socket.
3. Turn the handle ON to allow propane to flow to the drop in stove.

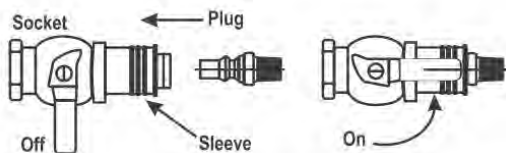

Quick connect coupler

Quick Coupler Connection

RANGE HOOD (IF SO EQUIPPED)

If your recreation vehicle is equipped with a range hood, it will be connected to an exterior vent.

The vent has an inner flap with two snaps. This flap can be snapped shut when the vehicle is in motion, or during storage to keep insects, debris, snow, rain, etc. from entering the recreation vehicle.



Range Hood Vent

Anytime the stove inside the recreation vehicle is being used, this flap **MUST** be unsnapped and the range hood turned ON to vent fumes outside the vehicle.

⚠ WARNING

Whenever the stove in the RV is being used: The range hood **MUST** be turned on, and the inner flap **MUST** be unsnapped and free to move. Failure to do so can create an asphyxiation hazard by restricting air flow to this vent.

COOKING WITH PROPANE

See the *Propane System Section* for important safety instructions. Refer to the manufacturer's owners manual for detailed operating and safety instructions for all propane appliances.

IN CASE OF A GREASE FIRE

⚠ WARNING

Do not attempt to use water to put out the fire. Water can spread some types of fire, and electrocution is possible with an electrical fire.

Grease is flammable. Never allow grease to collect around top burners or on the cook top surface. Wipe up spills immediately. Refer to Section 2 – Safety Precautions, for fire safety and fire extinguisher information.

REFRIGERATOR

The refrigerator is not intended for quick freezing or cooling. We recommend stocking it with pre-frozen or pre-cooled food when possible. The shelves should not be covered with paper or plastic and the food items should be arranged so air can circulate freely. Keep the area at the back of the refrigerator clean and free of debris. Check for obstructions in the exterior refrigerator vent area (i.e., spider webs, bird nests, etc.). Use a soft cloth to dust off the debris.

For optimum efficiency and performance, it is recommended the refrigerator be checked at least twice a year as part of the routine maintenance.

Gas/electric models (If So Equipped)

⚠ WARNING

If you smell propane gas **STOP!** Follow the directions located in your manufacturer's owner's manual and in this manual.

Residential models (If So Equipped)



NOTE: If you are using electric to power the refrigerator, make sure you are connected to a 120-volt power source.



CAUTION

The ice maker (if so equipped) should be turned off and the ice tray emptied when power to your recreation vehicle has been shut off. With no power, the ice will melt and water may “pool” in the refrigerator door. When power is restored, the vibration may cause this water to run out of the door and on to the vehicle floor.

For detailed operating and safety information, refer to the manufacturer’s user guide included in the Warranty Packet.

CLEANING YOUR REFRIGERATOR

The following are general cleaning guidelines. For detailed information on cleaning your specific refrigerator, refer to the manufacturer’s user’s guide.

Cleaning the interior

1. Unplug refrigerator or disconnect power.
2. Hand wash, rinse, and dry removable parts and interior surfaces thoroughly. Use a clean sponge or soft cloth and a mild detergent in warm water.
3. For the inside of the refrigerator, use a warm water and baking soda solution consisting of approximately 1 tablespoon (15ml) baking soda to 1 quart (1 liter) of water. This solution both cleans and neutralizes odors. Rinse and wipe dry.
4. Leave an open box of baking soda in the refrigerator and freezer compartments to help prevent odors.



NOTE: Do not use abrasive or harsh cleaners such as window sprays, scouring cleansers, flammable fluids, cleaning waxes, concentrated detergents, bleaches or cleansers containing petroleum products on plastic parts, interior and door liners or gaskets. Do not use paper towels, scouring pads, or other harsh cleaning tools.

There is no need for routine condenser cleaning in normal operating environments. If the environment is particularly greasy or dusty, or if there is significant pet traffic, the condenser should be cleaned every 2 to 3 months to ensure maximum efficiency.

If you need to clean the condenser:

- Remove the base grille.
- Use a vacuum cleaner with a soft brush to clean the grille, the open areas behind the grille and the front surface area of the condenser.
- Replace the base grille when finished.

Cleaning the exterior

Painted metal exteriors: wash with a clean sponge or soft cloth and a mild detergent in warm water.

Stainless steel exteriors: wash with a clean sponge or soft cloth and a mild detergent in warm water. Do not use appliance wax, polish, bleach, or other products containing chlorine

on stainless steel. Stainless steel can be cleaned with a commercially available stainless steel cleaner. A spray-on stainless steel cleaner works best.

IMPORTANT: Do not allow the Stainless Steel Cleaner and Polish to come into contact with any plastic parts such as the trim pieces, dispenser covers or door gaskets. If unintentional contact does occur, clean plastic part with a sponge and mild detergent in warm water. Dry thoroughly with a soft cloth.

For silver-accented plastic parts, wash with soap or other mild detergents. Wipe clean with a sponge or damp cloth. Do not use scouring pads, powdered cleaners, bleach or cleaners containing bleach as these products can scratch and weaken the paint finish.

WASHER/DRYER PREP (IF SO EQUIPPED)

If your recreation vehicle was built with washer/dryer prep, be aware the cabinet space provided is intended for the installation of an aftermarket washer/dryer combo unit (customer supplied) only. Please consult your dealer or the manufacturer for installation assistance.

A dryer vent opening must be cut into the sidewall of the recreation vehicle if installing a dryer. A label has been installed to assist you in placing the vent in the correct location. The label will be located in the area where the dryer will be installed.



Look for the dryer vent label on the wall in the location where the dryer will be installed. Instructions on how to cut the dryer vent hole and how to install the dryer vent in the wall of the recreation vehicle are included in your warranty packet.

⚠ CAUTION

Do not operate a dryer in the recreation vehicle unless the dryer is properly vented.

⚠ WARNING

Gas dryers should **NEVER** be installed in your recreation vehicle. Dryer prep has been designed for electric dryer operation **ONLY**.

WATER HEATER – SEE PLUMBING SECTION

OUTSIDE KITCHEN (IF SO EQUIPPED)

Typically outside kitchens consist of a 2-burner cooktop, refrigerator and sink. For detailed operation and safety information on the outside kitchen appliances, refer to the manufacturer's user guide.

Outside kitchen access and locking functions will vary depending on your model. Your recreation vehicle may be equipped with one of the following outside kitchens.

SECTION 10: APPLIANCES

Pull out kitchen style with strut support (if so equipped)

To access the kitchen unit, open the exterior door by lifting upwards until the door struts are fully extended. The struts will hold the door in the open position. Slowly pull the cooktop base towards you until the drawer guide stops are reached. Attach the cooktop to the propane connection (see quick coupler connection).

To return the kitchen unit to the stowed or travel position, disconnect the propane connection and slowly push the kitchen unit back to the retracted position. Close and secure the exterior door.

Pull out kitchen style with clip support (if so equipped)

To access the kitchen unit, lift the exterior door and secure it in the open position using the door clip. Be sure the door is secure in the open position before extending the kitchen unit. Locate the wood finger pull on the underside of the countertop and slowly pull the kitchen unit towards you until it is fully extended. Attach the propane connection (see “Attaching the “quick coupler” connection in the next section).

To return the kitchen unit to the stowed position, disconnect the propane connection and slowly push in at the center of the unit until it is all the way in (making sure the exterior door closes easily). Attach the strap that secures the cooktop during transit in place prior to closing and securing the exterior door.

Drop down kitchen style (if so equipped)

To access the kitchen unit, slowly open the exterior door from the top until it rests on the side support cables. Attach the cooktop to the propane connection (see quick coupler connection).

To return the kitchen to the stowed or travel position, disconnect the propane connection and return the exterior door to the closed position. Make sure the door is locked and secure for transit.

Pull out kitchen with a countertop extension

To access the kitchen unit, open the exterior door by lifting it up until the door struts are fully extended. The struts will hold the door in the open position.

Lift up the countertop extension and secure it in place by pulling the (2) wooden supports forward. Make sure the supports are pulled completely forward to insure proper support of the extension.

Locate the black locking lever at the base of the swing arm. Push in on the lever while pulling forward on the swing arm. Swing the cooktop unit open as far as the swing arm will allow.

Locate the support leg on the back side of the cooktop unit. Push in and hold the release button on the support leg while pushing the bottom of the leg extension in allowing it to drop from the stowed position to the support position.

Push in and hold the release button once again to allow the extension portion of the support leg to drop down to the appropriate height to support the cooktop unit. Make sure the support leg is setting on a stable solid surface.



Wood Support



Locking Lever

To return the kitchen unit to the stowed position, first disconnect the propane connection. Hold in the release button on the support leg and retract the lower portion of the leg. Swing the leg up into the stowed position and extend the leg into the storage bracket. Swing the cooktop back into the stowed position until it locks into place. Pull down on the exterior door until it is in the closed position. Make sure all exterior door locks are in the locked position prior to travel.

The cooktop will function more efficiently when level. The support leg should be adjusted to ensure the cooktop is as level as possible.

WARNING

The support leg must be down and in the support position prior to using the cooktop. Be sure the support leg is on a stable solid surface. Using the cooktop without the support leg or not having the leg on a stable solid surface may increase the risk of hot food or utensils falling off the cooking surface resulting in serious injury.

The following applies when using any outside kitchen configuration.

- Make sure all supports are securely in place before using the outside kitchen.
- Before using, make sure the propane connection is properly hooked up and secure.
- Do not leave the cooktop unattended while using.
- Keep all clothing and flammable material away from the cooktop while in use.
- Do not exceed the weight capacity of the outside kitchen unit.
- Disconnect the propane couple before stowing the outside kitchen unit.
- Make sure the kitchen unit is properly stowed and secured, and that the outside kitchen door is securely in place and locked before traveling.

WARNING

The maximum weight capacity of the outside kitchen unit is 50 lbs. Setting items on the kitchen unit that exceed this weight limit could cause damage to the unit or result in personal injury.

WARNING

Be sure to read, understand and follow all information supplied with your recreation vehicle concerning the use of propane before operating the BBQ grill. The propane hose must be correctly connected before lighting the grill. Failure to follow instructions supplied by the grill manufacturer, or use of any components other than those originally supplied with the grill, could result in death or serious injury.

Attaching the “quick coupler” connection

The “quick coupler” is directly connected to the RV propane system. The “quick-coupler” connection has a positive shut-off valve as required by code and standards.

1. Place the “quick coupler handle in the OFF position and push back the sleeve. The

SECTION 10: APPLIANCES

valve handle must be OFF to make the connection.

2. Insert the plug and release the sleeve.
3. Push the plug until the sleeve snaps forward, locking the plug into the socket.
4. Turn the handle ON to allow propane to flow to the drop in stove.

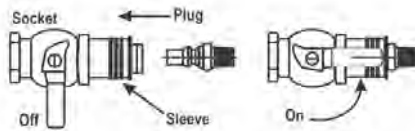

Quick connect coupler

SATELLITE (IF SO EQUIPPED)

Please refer to the manufacturer's instructions for setup, care and maintenance.

HDTV ANTENNA (IF SO EQUIPPED)



King Jack HDTV antenna



Enclosure base

Your recreation vehicle may be equipped with one of two types of exterior high definition TV antenna. Both antennas are capable of receiving any over the air (OTA) high definition television signals being broadcast in your receiving area.

King Jack Antenna Positioning: The knob on the enclosure base inside the recreation vehicle is used to rotate the outdoor roof antenna. The arrow on the knob should be pointed towards the TV signal source (the TV station). Press the button on the side of the knob and turn it to rotate the antenna for optimum signal. The antenna will rotate a full 360°.

Refer to the HDTV manufacturer's manual for detailed operating and safety information.



NOTE: This antenna is a fixed height (12") and cannot be lowered or raised. Trees and foliage will interfere with receiving a strong HDTV signal.



Winegard HDTV antenna



Interior base

Winegard Antenna Positioning: The knob on the interior base will rotate the antenna. Push up slightly on the inner piece, and rotate the knob to reposition the antenna. The antenna will rotate a full 360°. This antenna has a built in amplifier

SECTION 11: ELECTRONICS



NOTE: This antenna is a fixed height (8.4") and cannot be lowered or raised. Trees and foliage will interfere with receiving a strong HDTV signal.

Refer to the HDTV manufacturer's manual for detailed operating and safety information.

TELEVISION ROOF ANTENNA (IF SO EQUIPPED)

To view local stations at either (or both) the front or bedroom television sets using the television antenna, make sure the TV power supply is ON and the TV roof antenna is raised to the operating position.

The following is an overview of the antenna operation. Refer to the manufacturer's user guide for detailed operating instructions.

Raising the antenna

To raise the TV antenna to the operating position turn the antenna elevating crank clockwise in the UP direction (approximately 13 turns) until some resistance to turning is noted.

On amplified models, 12-volt DC power is required. After the position, pull down on the round knob with both hands until it clicks. Rotate the knob for best picture.



To Test

1. Make sure the television set is working properly.
2. Switch the power supply ON and OFF to see if there is a difference in the picture quality while watching TV. If there is no difference, refer to manufacturer's manual for further testing procedures.



CAUTION

The TV power supply should be turned OFF when connecting/disconnecting the cables to the power supply and antenna, but should be turned ON when testing for voltage.

Lowering the antenna

Rotate the antenna until the pointer on the directional handle aligns with the pointer on the ceiling plate. Turn the elevating crank counterclockwise in the DOWN direction until resistance is noted. The antenna is now locked in the travel position.



CAUTION

Make sure the television antenna is in the travel position (cranked down) before moving the recreation vehicle. Failure to lower the antenna into the travel position before traveling may damage the antenna.

DO'S

- Check parking location for obstructions before raising antenna.

- Carefully raise, lower and rotate. If this is difficult, check for cause.
- Rotate slowly when selecting station and check fine tuning on TV set to make sure it is properly adjusted.
- Lower antenna before moving vehicle.

DONT'S

- Don't force elevating crank up or down.
- Don't rotate directional handle hard against stops.
- Don't travel with lift in up position.
- Don't leave lift part way up or down.
- Don't apply sealing compound or paint over top of base plate or anywhere on lift.

Lubricating the antenna

The elevating gear should be lubricated 3-4 times a year with silicone spray.

Two times yearly or in the event rotating the antenna becomes difficult, normal operation can be restored by lubricating the bearing surface between the rotating gear housing and the base plate. Any **silicone lubricant spray** may be used.

Lubricate rubber quad ring on elevating shaft which is below worm gear with silicone spray lubricant at least twice yearly. This will keep quad ring from becoming brittle which could result in leaks down elevating shaft.

Refer to the manufacturer's user guide for detailed information on lubricating the antenna.

TELEVISION POWER SUPPLY (IF SO EQUIPPED)

For good station reception, the TV power supply must be turned ON to view local television stations. Turning the TV power supply ON sends 12-volt DC through the cable to the TV roof antenna. The voltage energizes the transistors in the antenna head amplifier. The TV signal then comes down the cable to the outlets.

Turn the TV power supply OFF to view cable television or to use a VCR or DVD.



TV Power Supply

SECTION 11: ELECTRONICS

Notes:

CLEANING THE INTERIOR

To keep the value of your recreation vehicle, perform regular maintenance using the proper materials and procedures. Using the wrong cleaner may result in damage to the surfaces in your vehicle. Check with the manufacturer's information for the recommended cleaning agent. If in doubt, check to see if the cleaner will cause damage by testing a small area out of sight or contact your dealer for assistance. Do not use flammable liquids or sprays to clean the recreation vehicle.

DÉCOR ITEMS

Décor items such as décor glass, furniture, window treatments, shades and blinds should be cared for as follows:

Décor Glass (if so equipped)

Use a glass cleaner to remove smudges, smears and spots. If there is any decorative etching on the décor glass, use care when cleaning around that area.

Furniture Upholstery

To retain the value of your recreation vehicle, maintain the furniture upholstery carefully and keep the interior clean. Vacuum the furniture regularly using a soft brush attachment to remove any loose dirt or debris.

Fabric (if so equipped)

It is recommended the fabric be professionally cleaned if it becomes stained or soiled. The professional cleaner should be made aware the fabrics that may have been treated to be fire resistant. For more information, refer to the specific furniture manufacturer's care instructions.

Ultraleather™ (if so equipped)

It is recommended the Ultraleather™ be professionally cleaned if it becomes stained or soiled. For more information, refer to the specific furniture manufacturer's care instructions.

Leather (if so equipped)

Periodic vacuuming, using a dry cloth to wipe up spills immediately, and using a damp cloth on problem areas, will help to keep your leather furniture in good condition. Leather surfaces can vary as do the cleaning methods. Refer to the furniture manufacturer's recommendation, or consult a cleaning professional.

It is recommended you do not use any cleaners containing oils, waxes or silicones. Cleaners containing silicone can eventually destroy the finish on the leather. Cleaners containing oils or waxes should not be used as they leave residues on the surface of the leather which can attract more dirt which can eventually lead to cracking

Window treatments

Fabric – Drapes and valances

Dust occasionally with a vacuum and soft brush attachment. It is recommended the fabric be professionally cleaned if it becomes stained or soiled. The professional cleaner should be made aware the fabrics that may have been treated to be fire resistant.

Window Shades

Shades should be vacuumed periodically to remove dust. It doesn't matter what type of shade or fabric you have, using your vacuum cleaners upholstery brush on low suction will remove most dust and dirt from the shade.

Refer to the shade manufacturer's owner's manual for additional and detailed information.

SECTION 12: INTERIOR

To remove stuck on dust or stains refer to the following guide.

Solar shields: Use a sponge or soft brush and water to remove stains. A mild cleaning solution can be used to remove tougher stains. Rinse after cleaning by wetting a clean cloth in fresh water, wringing out any excess and wiping the areas where the cleaner was used.

Day/night Shades: Clean with a mild cleaning solution using a sponge or paper towel. Wipe down with water after cleaning and dry thoroughly before raising the shade. Do not use spot remover, household cleaners or detergents to remove soiled spots, as these may cause damage to fabric or loss of color from fading.

Mini Blinds: A simple dry rag may do the trick. If they're especially dirty, you can use cold or warm water to clean them. But never use hot water.

Fill a spray bottle with water and a tiny amount of soap. Then spray a lint-free towel with the mixture and use the towel to wipe down each slat. While cleaning, try not to bend the slats. They can also be soaked in a bathtub to loosen up any debris so the slats can be wiped down easily.

Roller Shades: Can be easily cared for by simply using soapy water or a mild cleaning solution on spots. However try a small area first. Harsh household cleaners or detergents may cause damage to fabric or loss of color. It is our recommendation to dust the rails and fabrics of the shades on a regular basis. Shades should be kept in the closed or up position when not in use, to maintain pleat retention and minimize dirt and soil build-up. Do not store shades in the down position. This may cause some loss of pleat retention if the shades are not operated on a consistent basis.



NOTE: If your recreation vehicle must be stored for an extended period of time, store shades in the up position and cover your windows with additional protection (I.E. Cut out cardboard).

SOFA

Your recreation vehicle may be equipped with one of the following sofa styles.

Hide-a-bed Sofa or Sofa Sleeper

The hide-a-bed sofa functions much the same as a regular residential hide-a-bed sofa. To make the hide-a-bed sofa into a bed, remove the seat cushions and pull the sofa back towards you firmly and gently. Activate (or deflate) the air mattress (if so equipped) using the supplied furniture manufacturer's instructions. To convert the hide-a-bed back into the upright sofa position, reverse the process.

Jack Knife Sofa

The Jack Knife sofa functions much the same as a residential futon. To make the sofa into a bed, lift up on the bottom seat cushion and pull it towards you. The sofa back will drop down to provide a sleeping surface. For additional comfort and to reduce fabric damage, you may want to place a cover or air mattress (customer supplied) over the sofa when it is in the sleeping position.

Trifold Sofa The Trifold Sofa offers very similar features to the traditional hide-a-bed. The following illustrations detail converting the sofa into a bed.



1. Remove tri-fold sofa pillows and set aside



2. Using the strap handle, pull sleeping surface up, then out.



3. While sleeping surface is up, gold out legs. Extend sleeping surface until grounded.



4. Once sleeping surface is grounded, fold headboard down flat.

J-Cube Sofa

The J-Cube Sofa functions similar to a residential futon. The slanted back pillows offer numerous options as a sofa, along with the ability to extend the cushions for additional sleeping space.

FREE-STANDING TABLE & CHAIRS (IF SO EQUIPPED)

The free-standing dinette table can be positioned to seat up to four people. To prevent damage, the standard free-standing dinette chairs should be fastened securely at the dinette table when you are traveling

BOOTH DINETTE (IF SO EQUIPPED)

The dinette is designed to seat up to four adults. Depending on your model, there may be a storage area in the dinette bench. To access this storage, remove all the cushions and lift up on the bottom seat support. **If the bottom seat support is secured closed with screws, do not remove the seat support or use this area for storage.** The dinette seats that are secured with screws contain factory installed equipment and should only be accessed by a qualified service technician.

Converting the dinette to the bed position

Remove all the cushions from the booth dinette. Lift up the tabletop and remove the

SECTION 12: INTERIOR

detachable table legs. Place the tabletop on the ledges provided between the booth dinette benches. Lay the seat back cushions against the back of the dinette bench. Lay the dinette seat bottom cushions in between the seat back cushions. The area where the cushions meet should be slightly raised. Push the raised cushion ends down gently as the cushions are designed to fit snugly. Reverse this process when converting back to the booth dinette.

CABINERY & TABLES

To keep hardwood doors, cabinet fronts and hardwood tables looking like new regularly dust with a soft cloth dampened with a cleaning polish or mild detergent solution. Avoid using ammonia based products or silicone oils as they may cause damage if used over a long period of time.

The finish is durable and resistant to most household spills. However, spills should be wiped up promptly to avoid potential problems. Excessive prolonged exposure to direct sunlight, high temperatures and high humidity can cause damage to both the finish and the wood itself. These should be avoided.

PANTRY OR HUTCH (IF SO EQUIPPED)

Depending on the kitchen layout of your recreation vehicle, you may have a pantry or hutch that you can use to store items you wish to take with you as you travel and camp. Make sure all items stored in the pantry or hutch are secured so they do not shift during travel. This cabinetry has been designed to accommodate the normal camping items (i.e., paper plates, flatware, cookware, etc.) which are bulky but not necessarily heavy. **Remember your recreation vehicle's load capacity is designed by weight, not volume, so you cannot necessarily use all available space.**

If your pantry or hutch has sliding pantry shelves, they have been equipped with a locking mechanism to keep them in place during transit. To secure the shelf in place, push it all of the way in until the latch tab clicks into place. Always pull out slightly on the shelf to make sure that it is stationary and secure in the transit position. To release the shelf, push in on the tab and pull the shelf slowly towards you.

WARNING

Your recreation vehicle's load capacity is designated by weight, not by volume, so you cannot necessarily use all available space when loading the vehicle. Do not exceed your GVWR and ensure you are loading the vehicle as evenly as you can for the best possible handling. Ensure heavy items are secured so they do not shift during travel.

COUNTERTOPS

To prevent permanent damage

- Always use hot pads or trivets under hot pans, dishes, or heat producing appliances such as frying pans.
- Always use a cutting board; never use a knife on the countertop.
- Avoid harsh chemicals such as drain cleaners, oven cleaners, etc.
- Do not let cleaners with bleach set on the top. Wipe them off promptly.

For additional information on the removal of difficult stains or surface damage repair, refer to the countertop manufacturer's user guide.

Your recreation vehicle may be equipped with one or both of the following countertops.

Laminate countertops (if so equipped)

Glass rings, food spills, water spots and smudges usually wipe off with a damp sponge. Stubborn stains can be removed with a general-purpose spray cleaner. Some stains can be removed by squeezing fresh lemon juice over the stain and allowing the juice to soak for approximately forty-five minutes. After 45 minutes, sprinkle baking soda over the lemon juice and rub with a soft cloth.

Solid surface countertops (if so equipped)

Solid surface materials are easy to care for, and if damaged, easy to repair. Soapy water, ammonia based cleaners (not window cleaners as they can leave a waxy build up that may dull the surface) or commercially available solid surface cleaners will remove most dirt and residue from all types of finishes. A damp cloth followed by a dry towel will remove watermarks.

Difficult stains can be removed from the matte finish with a green Scotch Brite® pad and a mild abrasive cleaner.

Disinfect the surface periodically with diluted household bleach (one part water to one part bleach). For cuts and scratches, sand the matte finish lightly with (220) fine grit sandpaper until the cut or scratch is gone. Restore finish with a green Scotch Brite® pad and mild abrasive cleaner.

Helpful hints

- Use a cutting board to prevent unnecessary damage to the countertops. Do not cut directly on the solid surface countertop.
- Use potholders or trivets before placing hot pots and pans on the countertop. Heat will damage the countertop.
- Run cold water when pouring hot/boiling water into the sink.

Solid surface sink maintenance

Occasionally, clean the solid surface sink by filling one-quarter full with a 50/50 water/bleach solution. Let soak for 15 minutes, and then wash sides and bottom of sink as solution drains.

INTERIOR WALL PANEL

Please contact your dealership service department for assistance in repairing décor paneling. If deep scratches occur on the wall panel, putty sticks can be used to cover scratches on wood surfaces. These can be obtained from local hardwood stores and lumberyards.

To clean, use a mild solution of soap and lukewarm water with a soft sponge or cloth. Wipe dry with a soft, clean cloth.

 CAUTION
--

Do not use abrasive cleaners as they may cause the vinyl to scratch and become dull. Do not use cleaners that contain bleach
--

FLOORING

Always test a cleaning agent in an inconspicuous area for colorfastness.

SECTION 12: INTERIOR

Carpet

Vacuum your carpet regularly. It is important to remove loose soil and debris while it is on the surface. Heavily traveled areas (i.e., walkways, areas in front of the furniture) may be protected with small throw rugs to prolong the life of the carpet.

Prompt attention to spots and spills is essential. Remove as much of the spill as possible. Absorb wet spills as quickly as possible by blotting repeatedly with white paper or cloth towels.

Refer to the manufacturer's guide included in your Warranty Packet for detailed cleaning information, or contact a cleaning professional.

Vinyl flooring

Periodically vacuum or sweep to remove dirt and gritty particles. Although most common spills will not permanently stain the vinyl floors, they are usually easier to remove if wiped up before they set. Simply blot with a paper towel and wipe clean with a damp cloth. Do not use dish detergents or vinegar and water because they will dull your floor.

To care for the vinyl floor covering, use a damp mop with water and a mild cleaner on the entire floor. **DO NOT SOAK THE FLOORING.** Use care to avoid wetting the carpet edges. To avoid problems of "yellowing" linoleum, the flooring manufacturer recommends avoiding cleaners that contain oil based solvents (i.e. cleaners containing lemon oil, Murphy's Oil Soap, etc.).

MURPHY BED (If So Equipped)

Your recreation vehicle may be equipped with a folding Murphy bed. When in the closed position, the bed is stored in the wall allowing for more living space within the vehicle. When you want to use the bed, the sofa folds flat and the bed can be pulled down over sofa into the sleeping position.



Stored position



Sleeping position



CAUTION

The slide out **must be fully extended** before putting the Murphy bed in the sleeping position. The Murphy bed **must be in the stored position** before the slide out can be moved to the in (travel) position. Failure to do so may result in injury or property damage

This label has been installed in your recreation vehicle at the foot end of the Murphy bed.

It should not be removed.

NOTICE
<p>The murphy bed must be folded up and secured in place before moving the slideout to the in position.</p> <p>Moving the slideout before the bed is properly stored and secured may result in damage to the bed and /or slideout.</p>

Unfolding the sofa:

With the slideout fully extended, unfold the sofa into the flat position.

- Standing at the side of the sofa, grasp the front of the seat cushion and the top of the back cushion (Fig. A).
- Lift up on the seat cushion while pulling the top of the back cushion in toward the seat. The seat and back will form a “V” shape. (Fig. B)
- Pull the seat cushion out away from the front of the sofa into the flat position (Fig. C).



Lowering the Murphy bed:



- Unlatch the “D” bolt latches on each side of the bed at the footboard (in the stored position). This will release the Murphy bed allowing it to unfold.
- Firmly grasp the handle on the footboard of the Murphy bed, and pull it towards you. The bed will begin to unfold. Pull it all the way down so the footboard rests on the floor.
- When the bed is in the sleeping position, locate the web straps with snap hooks on the footboard of the bed (there is one on each side of the bed). Attach (both) snap hooks to the metal loops located on the sofa arms. ***These straps and loops keep the bed from folding up while in use.***

⚠ WARNING

Snap hooks must be attached to the steel rings on the sofa arms before using the bed. Failure to attach these snap hooks to the steel loops on the sofa can result in serious injury or property damage.

NOTE: The straps are adjustable. They have been installed at a length that holds the bed securely in place and allows ease of attaching the snap to the metal loops.

This label is located below next to the slide out controls inside the entrance door.

It should not be removed.



CAUTION

The two straps on both sides of the Murphy bed must be secured to the D-rings on each side of the sofa anytime the bed is in the down position to prevent inadvertent lifting.

The bed can lift or fold up unexpectedly which could result in personal injury.

Remove the straps holding the mattress to the bed frame by unsnapping the two plastic buckles on top of the mattress. These straps can be stored on the side of the mattress, or tucked between the headboard and the mattress. Release the mattress hook from the foot of the bed.

MAKE SURE THE SAFETY STRAPS AT EACH SIDE OF THE FOOTBOARD ARE ATTACHED TO THE STEEL LOOPS ON THE SOFA ARMS BEFORE PUTTING ANY WEIGHT ON THE BED.

Storing the Murphy bed:

- Attach the “Y” strap that holds the mattress to the bedframe. Pull the straps with the buckles up from the head of the bed and snap them to the “Y” strap. Secure the snap hook at the footboard.
- MAKE SURE THE SAFETY STRAPS AT EACH SIDE OF THE FOOTBOARD ARE STILL ATTACHED TO THE STEEL LOOPS ON THE SOFA ARMS BEFORE PUTTING ANY WEIGHT ON THE BED.**
- Unhook the safety strap snap hooks from the steel loops on the arms of the sofa.
- Push the bed back up into the storage position.

⚠ WARNING

Keep hands and fingers away from the collapsing footboard and struts when pushing the bed back in to the storage position.

- Secure the two “D” bolts on each side of the bed
- Flip the sofa back up into the seated position:
 - Firmly grasp the edge of the top cushion and the front edge of the seat cushion.
 - Push the cushions down and towards each other so they form a “V” shape.
 - While holding the cushions in this “V” shape, rotate the sofa back towards the wall and the cushions will revert back to the seated position.

ABS PLASTICS

Dust and wipe clean with soft, damp cloth or chamois, wiping gently. Do not use gritty or abrasive particle soaps or scouring compound to clean ABS plastic. Avoid using “citrus” or biodegradable cleaners which contain “D-Limonene” as they may damage plastic materials.

SECTION 12: INTERIOR

Notes:

CLEANING THE EXTERIOR

To protect your recreation vehicle's exterior finish, wash it often and thoroughly.

For recreation vehicles with painted exterior graphics: If desired you may wash and wax your vehicle 60 days after purchase. The exterior paint does need time to cure before any wax is applied to the exterior surface. Careful maintenance for the first 60 days will assure a long lasting durable finish.

Your recreation vehicle is exposed to many environmental conditions that have an adverse affect on the paint finish:

- Road Salt and Sodium Chloride
- Road Tar / Bugs
- Bird Droppings / Tree Sap
- Industrial Fallout / Acid Rain /Pollution
- UV Exposure and Moisture

The most common problems resulting from these conditions are corrosion, staining, and chemical spotting. Generally, the longer the foreign material remains in contact with the exterior finish, the more extensive the damage. These problems can be minimized by regularly scheduled washing and polishing. Wash your recreation vehicle as soon as possible if it becomes contaminated with foreign material.

Avoid parking under trees or near ocean sea salt. Ice or snow should not be scraped from the painted surface: Brush off!

Gravel roads should be avoided. Anti-freeze, gasoline or washer solvents if spilled on the painted surface should be rinsed off with water immediately. Bugs and bird droppings should be rinsed off daily.

Washing

Commercial washing should be avoided. Wash with cold water using a mild liquid soap. Dry wiping with a dry cloth is not recommended.

Make sure the recreation vehicle's surface temperature is cool, under 90 F, and out of direct sunlight. A shaded area is ideal for washing your vehicle as direct sunlight causes water spotting. Use a mild soap or detergent. Most auto care stores will carry a car wash shampoo. Try to avoid combination wash-n-wax products as these waxes can cause build up and are designed for smaller surfaces. Have two dedicated sponges or wash mitts: one for the exterior walls and one for the wheels and under- carriage. Brushes or wash mitts that are made of plastic bristles are acceptable for use on tires and wheel wells, but are not intended for use on the exterior walls. Avoid using such items on painted surfaces as they will damage the finish. Wash the wheels and wheel wells first as this removes heavy dirt and debris and prevents it from splattering on panels. Wet the entire area down to remove loose dirt and grime, then hand wash one area at a time using your dedicated paint finish sponge or wash mitt.

Wash from the top and work your way down, rinsing frequently to minimize grit abrasion. Follow with a final rinse of water. This process will remove most contamination from the recreation vehicle's surface. For stubborn stains such as road tar or bug stains, use an ammonia based glass cleaner or a small amount of rubbing alcohol on a damp cloth followed immediately by warm soapy water, and rinsing with clean water.

This may not dissolve the road tar, but it will loosen tar and bug stains and remove them from the surface. Do not use solvent based cleaners on bird droppings or tree sap as these are water based stains. They can be dissolved using ammonia based glass cleaner, warm soapy

SECTION 13: EXTERIOR

water and a little “elbow grease”. Once again, after removing stubborn stains immediately rinse with clean water.

Drying the recreation vehicle is just as important as washing your vehicle. Tap and well water contain many chemicals that could water stain your vehicle’s finish. We suggest using a damp natural or synthetic chamois. There are other drying products such as lint-free micro-fiber towels that work just as well.

During cold weather

Salt and other chemicals that are spread on winter roads in some geographical areas can have a detrimental effect on the recreation vehicle’s underbody. **If your recreation vehicle is exposed to these conditions, spray the underbody with a high-pressure hose every time you wash the exterior of your recreation vehicle.**

Take special care to remove mud or other debris that could trap and hold salt or moisture. After washing your recreation vehicle, wipe off all water drops from the rubber parts around the slideout and doors.



NOTE: When the slideout or door is frozen, opening it by force may tear off or crack the rubber gasket that is installed around the slideout or door. Therefore, pour warm water on the gasket to melt the ice (wipe off the water thoroughly after opening the slideout or door). To prevent the weather stripping from freezing, treat it with a silicone spray.

Waxing

Wax your recreation vehicle once or twice a year, or when painted surfaces do not shed water well. Use a soft cloth to apply a small amount of wax to the painted surfaces. After the wax has dried, polish the recreation vehicle with a dry, soft cloth. Do not wax your recreation vehicle in direct sunlight. Wax it after the surfaces have cooled.

Do not apply wax to any area having a flat black finish as it can cause discoloration. If the finish has been stained with wax, wipe off the area with a soft cloth and warm water. When waxing the area around the various openings, do not apply any wax on the weather-strip. If it is stained with wax, the weather-strip cannot maintain a weatherproof seal around the opening.



CAUTION

Do not use waxes containing high-abrasive compounds. Such waxes remove rust and stains effectively from the paint work, but they are also harmful to the luster of the painted surface since they scrape off the coating. Further, they are detrimental to glossy surfaces, such as the grille, garnish, moldings, etc. do not use gasoline or paint thinners to remove road tar or other contamination to the painted surface.

Polishing your recreation vehicle

If painted surfaces have been severely damaged and have lost their original luster and color tone, polish the surface lightly with a fine polishing compound. Avoid limiting your polishing to the damaged surface only; polish a somewhat wider area, moving the polishing cloth in one direction. After polishing, flush the compound from the surface and apply a coat of wax to regain a beautiful luster.

 **CAUTION**

Do not use a buffer and a buffing compound as it may damage the exterior surface. Please contact a professional paint body shop for assistance

Damaged paint

To prevent corrosion, touch up small cracks and scratches in the paint coat as soon as possible with touch-up film or paint. Carefully check the body areas facing the road and the tires for damage to the paint coat caused by flying stones, etc. To purchase touch-up paint, use the closest automotive paint (available locally) match possible.

Cleaning plastic parts

Use a sponge or chamois to clean plastic parts. Use warm water and a soft cloth or chamois to remove any white residue from dark colored plastic surfaces. Do not use a scrubbing brush, other hard tools, or wax containing abrasives as they may damage the plastic surface.

 **CAUTION**

Do not allow plastic to come into contact with brake fluid, engine oil, grease, paint thinner, or battery acid. These will damage plastic. Use a soft cloth and a mild detergent solution to wipe away any such contact.

Chrome parts

To prevent chrome parts from spotting or corroding, wash with water, dry thoroughly, and apply a non-abrasive automotive wax. If the chrome is severely damaged or pitted, use a commercially available chrome polish product.

FRAME

Sand, pebbles, objects on the highway, climate (salt air exposure) or ice inhibiting chemicals used during the winter months will damage the paint, inviting rust and other deterioration. Periodically inspect the exterior exposed areas, clean and repaint the frame members occasionally and whenever you notice rust or paint chipped away, to insure protection.

E-Z LUBE OR SUPER-LUBE AXLE (IF SO EQUIPPED)

The E-Z lube or Super-lube feature on your axles provides the ability for the bearings to be periodically lubricated without removing the hubs from the axle. This feature consists of axle spindles that have been specially drilled and fitted with grease zerks in their ends. When grease is pumped into the zerk, it is channeled to the inner bearing and then flows back to the outer bearing and eventually back out the grease cap hole. If you have further questions, consult with your dealer.

SECTION 13: EXTERIOR



NOTE: The convenient lubrication provisions of the E-Z lube or Super-lube feature must not replace periodic inspection and maintenance of the bearings. Use a hand-operated grease gun; improper use of a commercial grease gun may damage the seals.

EXTERIOR ROOF & SIDEWALL VENTS

While you are cleaning the exterior roof assembly, also inspect the roof vents (including sealants) for cracks and keep them clean. Inspect the refrigerator and holding tank vents for blockages from bird nests, spider webs, leaves, etc. All exterior access doors and vents need to be kept clean and free of obstructions (i.e., insect nests, mud daubers, etc.) while the appliances are in use.

WINDOWS

Any ventilating window may permit water inside, especially during heavy rainstorms. Condensation will also cause water to accumulate on windows and in the tracks.

The window “glass” can normally be cleaned with a sponge and water. Use glass cleaner to remove wax, oil, grease, dead insects, etc. After washing the glass, wipe it dry with a clean, soft cloth.

EXTERIOR LADDER (If So Equipped)

Your recreation vehicle may be equipped with an optional roof ladder. The recreation vehicle roof has decking under the rubber roof membrane to allow you to walk on the roof (with caution) to do maintenance.

WARNING

If your recreation vehicle is equipped with a roof ladder, do not leave items attached to it while traveling. The ladder weight capacity should not be exceeded (see ladder capacity label). **DO NOT** exceed this weight limit. There should never be more than one person on the ladder at the same time

SEALANTS

CAUTION

Failure to properly maintain or reseal your recreation vehicle may result in serious water damage to the roof and other parts of the recreation vehicle. This damage is not covered by the **Towable Limited Warranty**.

Sealants perform a very important function and should be inspected closely and regularly maintained. We incorporate many different types of sealants, including butyl/putty, black butyl-encapsulated foam, silicone (clear and colored), roof sealant and foam. In general,

sealants do not have “set” lifetimes. Varying environmental factors affect the pliability and adhesiveness of sealants.

You or your dealer must:

- Inspect all sealants, a minimum of every six months. Make sure to check the roof and all four sides of the recreation vehicle including all moldings, doors, vents and exterior attachments. A quick walk around the recreation vehicle before leaving may help prevent potential problems during trips and vacations.
- Have the sealant replaced if you notice any cracks, peeling, voids, gaps, breaks, looseness or any sign of physical deterioration. Reseal at least one time each year as preventative maintenance.
- Always use the same type of sealant that was removed. Your dealer recreation vehicle service or parts manager can help you obtain the correct sealant(s).

The sealants may become damaged due to road vibration, ultraviolet exposure, air pollution, freezing temperatures and exposure to other elements. If deteriorated, repair immediately to prevent damage.

If you notice water inside the recreation vehicle, immediately have the dealer check for the source of the leak. Failure to correct the leak may result in serious damage to your recreation vehicle; this damage may not be warrantable.

Although the diagrams below may not accurately reflect the exact model of your recreation vehicle, make sure you inspect all sealants as indicated in the text. If you have questions and/or need assistance with sealing your recreation vehicle, consult with your recreation vehicle dealer.

TRAVEL TRAILERS - SEALANT DIAGRAM

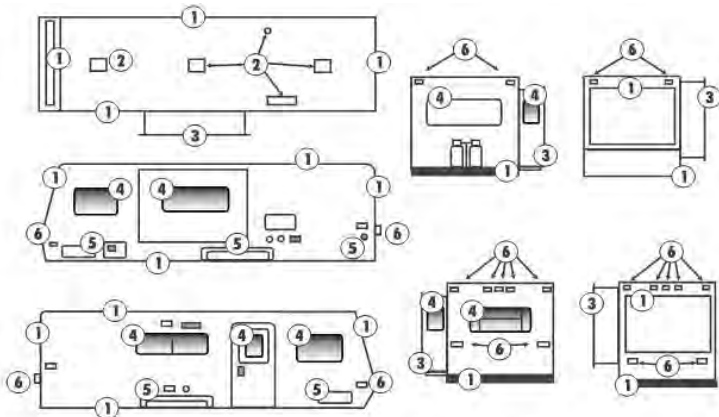

- 1. Trim Edges**
- 2. Roof items**
- 3. Slideout Roof/Floor**
- 4. Windows/Doors**
- 5. Storage Compartments/
Access Doors/Wheel Wells**
- 6. Lights**

SECTION 13: EXTERIOR

Notes:

RV START-UP

The following checklist will help ensure a trouble-free camping season:

- Inspect and work all interior and exterior latches and locks (lube if necessary).
- Make sure the batteries are fully charged and installed correctly.
- Inspect the power cord and carefully clean the contacts if necessary. Plug in the power cord to an appropriate power source.
- Turn on the interior lights and check outlets for polarity. If needed, replace any blown fuses. Check the circuit breakers and test the GFCI.
- Inspect and test all safety detectors. If needed, replace any drained or discharged batteries. If you have a defective or damaged safety detector, replace it immediately.
- Inspect and turn on the propane system. If you have any questions, contact your dealer or a qualified propane service representative for assistance.
- If the propane system is functioning properly, test any pilot lights or direct spark ignition features.
- Inspect the leveling jacks (if so equipped) for operation. If needed, perform maintenance as specified by the leveling jack manufacturer.
- Test all exterior and interior lights. Replace any bulbs if they are burnt out.
- Inspect the tires for wear, cracks and inflation pressure.
- Wash the exterior of the RV. Do a sealant inspection and repair as necessary.
- De-winterize and sanitize the fresh water system.
- Connect your tow vehicle to the RV and test all connections and lights.

READY TO LEAVE & MAINTENANCE CHECKLIST

Before leaving or returning home, it is critical that you complete the necessary procedures to ensure a safe trip. This is a general list, which you may want to customize as you determine your own needs

- Make sure you follow all safety precautions noted in this owner's manual and in any manufacturer's operators manual when preparing to travel.
- Check the area under the RV after overnight parking and look for water or other fluid leaks. If leaks are detected, find the cause and correct it immediately.
- Make sure all tow vehicle fluids are at proper levels. Check the engine oil, transmission fluid, engine coolant, power steering fluid and wind shield washer fluid.
- Check the lights on the RV. Have someone observe the operation of all exterior lights while you activate the controls. Check the turn signals and brake lights.
- Examine the tires for excessive tread wear or uneven wear patterns. Check for stones, nails, glass or other objects lodged in the tread. Inspect for tread cuts or sidewall cracks.
- Check wheel lug nuts for tightness and tires for proper air inflation pressure.
- Check the propane cylinder gauge to make sure there is propane available. Make sure the propane cylinder is in place and secure for transport.

Interior

- Close roof vents.
- Close windows & latch blinds.

SECTION 14: TRAVEL/CAMPING/STORAGE CHECKLISTS

- Counter items put away or tied down.
- Furnace turned off.
- Latch drawers, cabinets & doors.
- Turn off interior lights and appliances.
- Disconnect any cable TV or phone hookup, and lower the TV antenna (if so equipped).
- Move slideout(s) in and lock it in place (if so equipped).
- Fasten and secure the furniture for travel (if so equipped).
- Refrigerator door locked (if so equipped).
- Set refrigerator to 12-volt (if applicable).
- Water pump and water heater turned off (if so equipped).

Exterior

- Empty black and gray holding tanks, rinse as needed (if so equipped).
- Pack equipment into compartments and secure it.
- Propane turned off.
- Retract awning and secure in place for transport (if so equipped).
- Retract step.
- Snap the Range Hood vent closed (if so equipped)
- Retract leveling jacks to the travel position (if so equipped)
- Water hose & electric cord unhooked and stored.
- Test brakes for proper operation.
- Secure any loose, heavy or sharp objects in the RV or exterior compartments.
- Fasten all interior and exterior doors securely. Lock them (if so equipped).
- Secure and lock the entrance door.
- Walk around your RV one last time to make sure everything is stored away and the baggage compartments are closed and locked.

Maintenance Checklist

This list is a quick reference sheet for suggested areas of regular maintenance. Review all manufacturer's operators manuals supplied with your RV to perform these listed maintenance items.

Prior to First Trip

- Inspect and reseal as needed.
- Have the propane system checked for leaks by your dealer.
- Check wheel lug nuts at specified intervals to listed torque specifications, re-torque as needed.
- Sanitize the fresh water system.
- Test the safety alarms.

First Two-Hundred Miles

- Check wheel nuts at specified intervals to listed torque values. Re-torque as needed.
- Have brakes adjusted by a qualified service technician.

Each Trip

- Inspect and reseal as needed.
- Check the auxiliary battery (If so equipped).
- Have the propane system checked for leaks by your dealer.
- Check running lights.
- Check tire pressure and wear, including spare (if so equipped). Make sure the tires are cold when checking the tire pressure.
- Flush out water heater tank.
- Inspect safety chains for signs of wear.
- Test brakes.
- Test safety alarms.

RV STORAGE

Properly preparing your RV for storage during periods of non-usage will prevent problems from arising. It will also make it easier to get started again for the following camping trip or season. To prevent costly freeze-ups, winterize the plumbing system when it will not be in use for an extended period of time, especially if it is stored in colder climates.

Periodically inspect your RV for damage during storage, and seal off any area that can offer an entry point for rodents, birds or insects. **Damage from birds, rodents, insect, etc., is not covered under the “Towable Limited Warranty” applicable to your RV.**

When storing your RV, it is recommended that the auxiliary battery (customer supplied) be disconnected to avoid battery discharge.

Prior to Storage

If storing for the winter, be sure the RV is winterized (refer to *Sec. 8 Plumbing System, Winterizing the plumbing system*).

- Check your roof and other surfaces to ensure there is no damage and potential leakage that might otherwise go unnoticed until it is too late.
- Close all windows and roof vents.
- Close the propane cylinder valve(s). If you do not have a propane cylinder cover, we recommend purchasing one to make sure the regulator is covered.
- Cover all external outlets, such as furnace, exhaust, etc. to prevent mice or other rodents from entering.
- Cover the roof air conditioner (if so equipped).
- Disconnect 120-volt AC power to the RV.
- Do not use the stabilizing jacks during storage.
- Drain all water lines.
- Drain and flush all holding tanks (fresh water, gray water, black water and/or hot water tanks).
- Remove all batteries from the RV and store in a place where they won't freeze. Batteries that have been frozen will never hold a proper charge.
- Store your RV indoors, under a roof or purchase a “breathable” cover for use during storage.

SECTION 14: TRAVEL/CAMPING/STORAGE CHECKLISTS

- Thoroughly wash the interior and the exterior of your RV.
- To prevent weather checking and other UV damage, cover tires that are exposed to sunlight.
- Turn all cushions on edge to prevent the moisture/mildew buildup during storage.
- Turn off 12-volt DC/120-volt AC/propane to the refrigerator; defrost and clean (if so equipped). Prop (or block) the doors open so air can circulate and prevent mildew or use crumpled newspaper or open boxes of baking soda in the refrigerator to eliminate odors during storage.
- Remove all perishables from the cabinets. Leave the cabinets and doors ajar to allow air circulation and prevent mildew and musty odors.
- Remove all perishables from the cabinets. Leave the cabinets and doors ajar to allow air circulation and prevent mildew and musty odors.
- Lubricate locks and hinges on exterior doors.

During Storage Period

Remove snow from the top of your RV to prevent damage to the unit's structure.



CAUTION

Excessive snow, 8" or more, or ice, 2" or more, places excessive weight on the RV roof. Remove excessive snow or ice as needed. Care **MUST** be exercised to not damage the roof material when removing snow & ice. Excessive weight can damage the roof, seals, etc. Water leaks and poor fit or operation are the results of this damage.

FEATURED COMPONENTS QUICK REFERENCE CHART

Your recreation vehicle may be equipped with some of the items listed below. This is a partial listing and it is not intended to cover all components. All information is the latest available at the time of publication. Jayco reserves the right to change any of the following information without notice.

COMPONENT	MANUFACTURER	WEBSITE
Air Conditioner	RV Products	www.rvcomfort.com
Awning	Carefree of Colorado	www.carefreeofcolorado.com
Axle	Lippert Components	www.lci1.com
DVD/CD	See manufacturers' user guide	
Entrance Step	Lippert Components	www.lci1.com
Fan, Exhaust 12V	Ventline	www.ventline.com
Fire Extinguisher	See manufacturers' user guide	
Furnace	Atwood/Hydroflame	www.atwoodmobile.com
Microwave	See manufacturers' user guide	
Monitor Panel	KIB Enterprises	www.kib.us
Outside Shower / Utility Center	B & B Molders	www.bandbmolders.com
Propane Tank	Manchester Tank	www.mantank.com
Propane/Carbon Monoxide Alarm	See manufacturers' user guide	
Propane Regulator	Dehco	www.dehco.com
Range/stove/cooktop	Atwood Suburban Dehco	www.atwoodmobile.com www.suburban-manufacturing.com www.dehco.com
Range hood	Ventline Inc.	www.ventline.com
Refrigerator	Norcold Frigidaire Dometic Pummel Drive GE	www.norcold.com www.frigidaire.com www.dometic.com website not available www.ge.com
Smoke Alarm	See manufacturers' user guide	
Tank Sprayer/BLK	B & B Molders	www.bandbmolders.com
Thermostat	RV Products	www.rvcomfort.com
Toilet	Thetford Corp.	www.thetford.com
TV	See manufacturers' user guide	

SECTION 15: ADDITIONAL INFORMATION

TV Antenna	Winegard Company	www.winegard.com
Water Heater, Tank DSI	Atwood Greenbrier	www.atwoodmobile.com
Water Heater, Tankless	Girard Systems	www.greenrvproducts.com
Water Pump, 12V	Shurflo East	www.shurflo.com

VEHICLE MAINTENANCE RECORD

Make:	
Model:	
Model Year:	
Vehicle Serial#:	

Service Date	Mileage	Work Performed	Performed By	Notes

SECTION 15: ADDITIONAL INFORMATION

Service Date	Mileage	Work Performed	Performed By	Notes

Notes:

SECTION 15: ADDITIONAL INFORMATION

Notes:

SECTION 15: ADDITIONAL INFORMATION

Jayco

Ownership Notification

Fax Form To: (800) 825-7876

ATTENTION!

Federal record keeping laws require that we maintain a file of owners of our product. Your cooperation in filling out this form will be appreciated.

Change of Owner

Transfer of Limited Warranty
(see limited warranty for details)

Model Information:

Serial#: _____

Chassis #: _____ **Odometer Reading** _____
(Motorized only)

New Owner Information:

Purchased Date: _____

Name: _____

Address: _____

City: _____ **State/Province:** _____ **Zip Code** _____

Phone # _____ **E-Mail Address** _____

Previous Owner Information:

Purchased Date: _____

Name: _____

Address: _____

City: _____ **State/Province:** _____ **Zip Code** _____

Phone # _____ **E-Mail Address** _____